

DATA SHEET

# TINY KITCHEN «OFFICE»



# OVERVIEW \_ UNITS

Legende:  Kochfeld mit Abzug,  Geschirrspüler,  Mülltrennsystem,  Kühlschrank,  Backofen,  Weinkühlchrank,

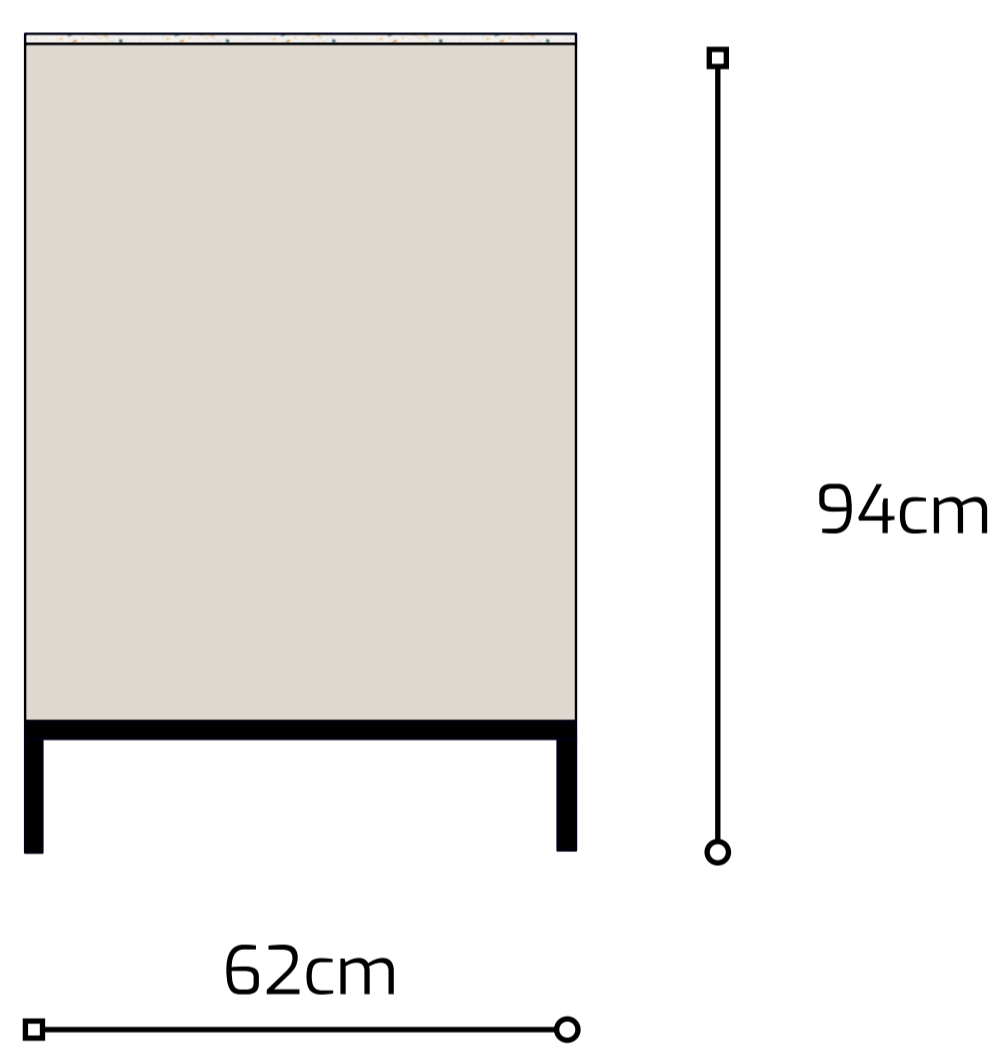
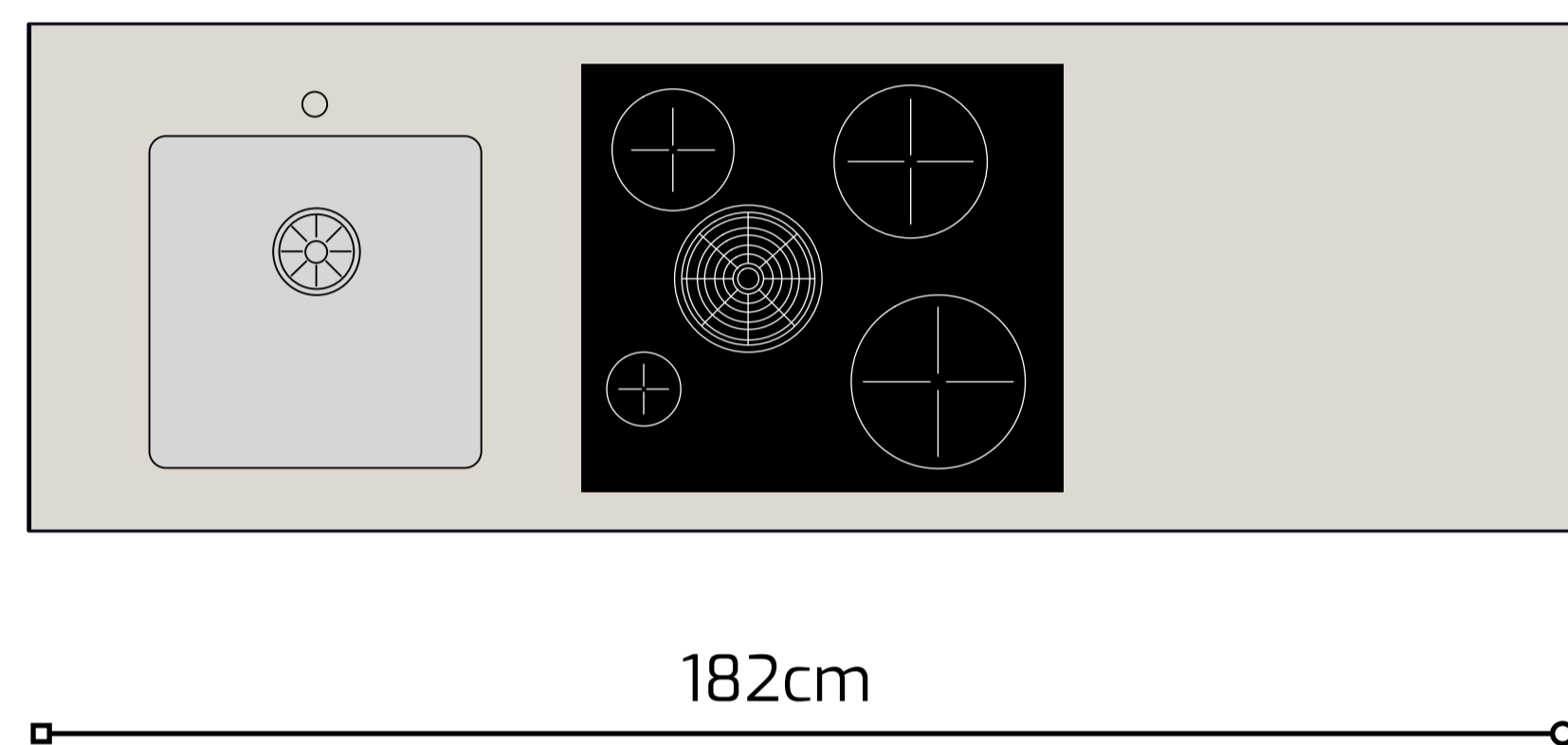
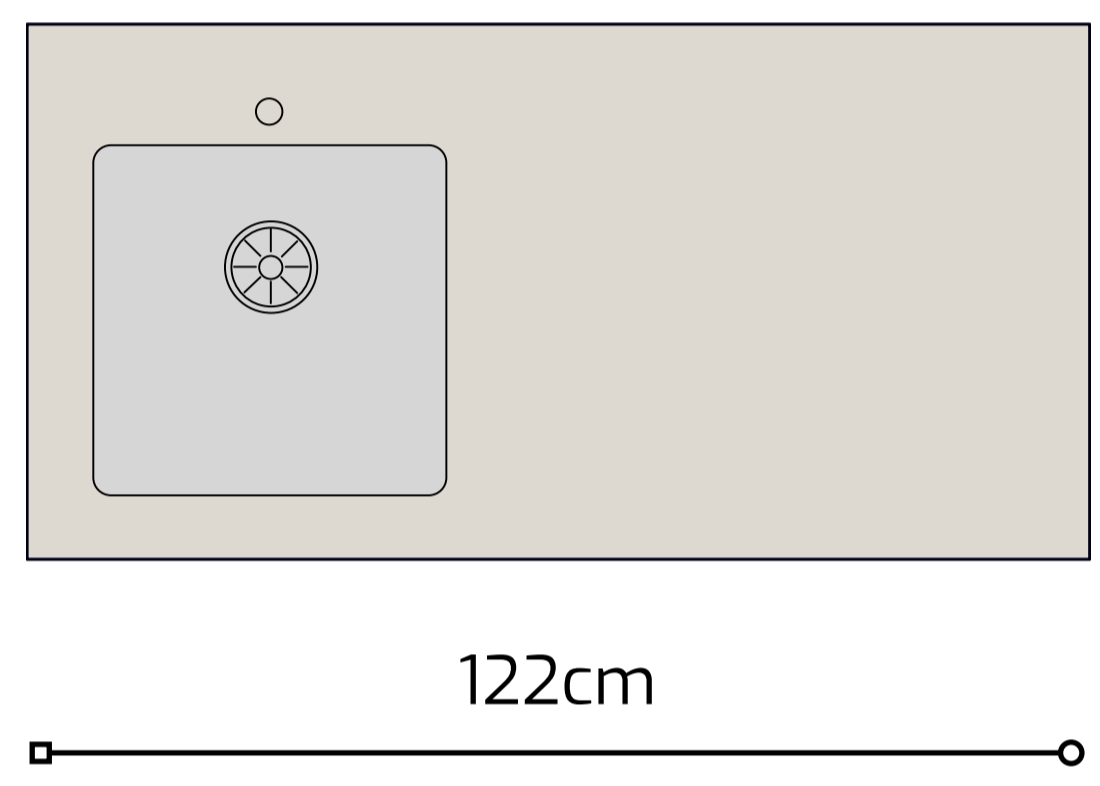
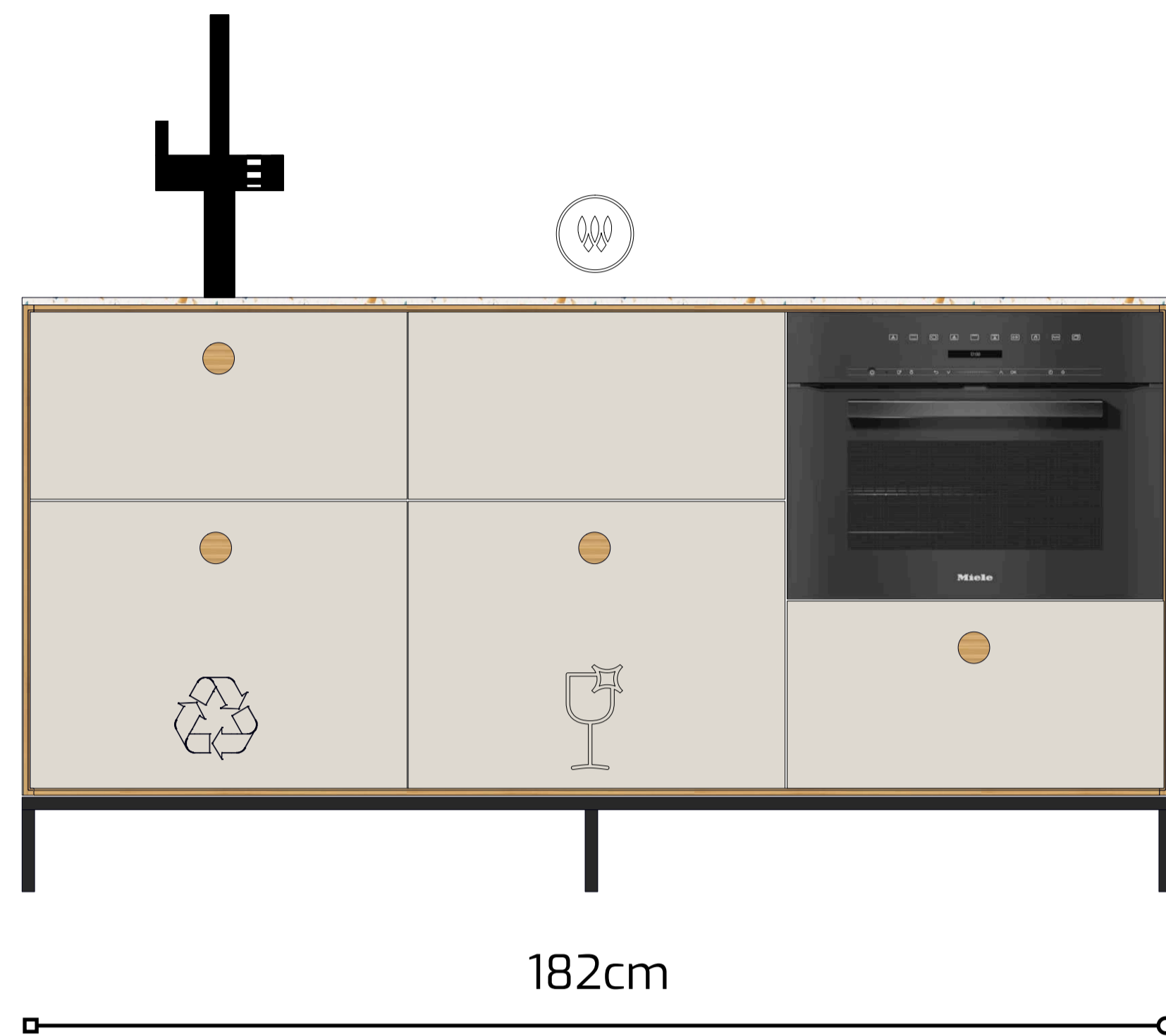
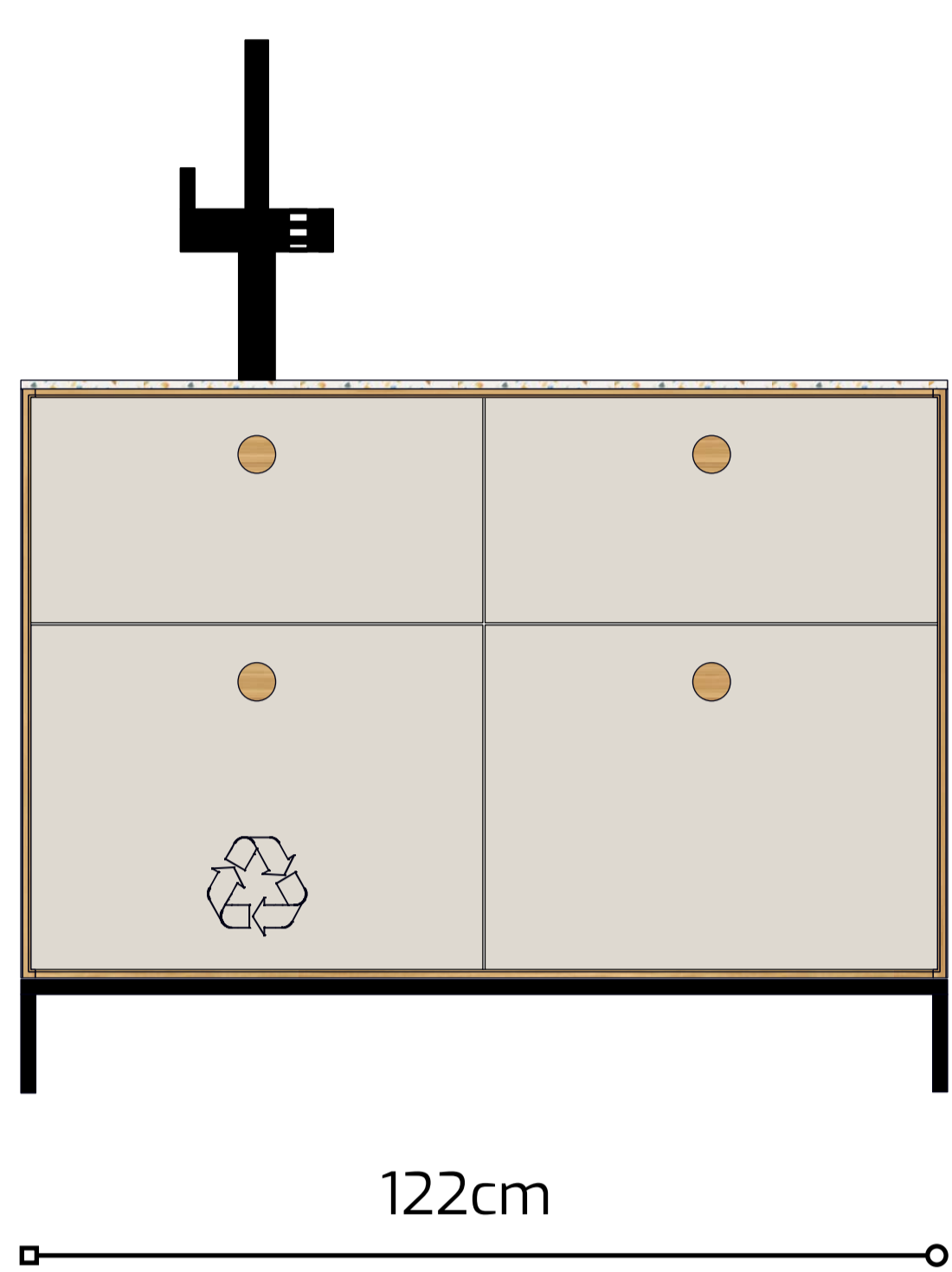

BASE UNITS

TALL UNITS

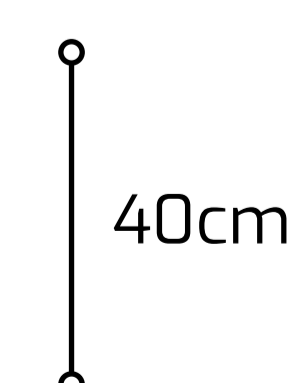
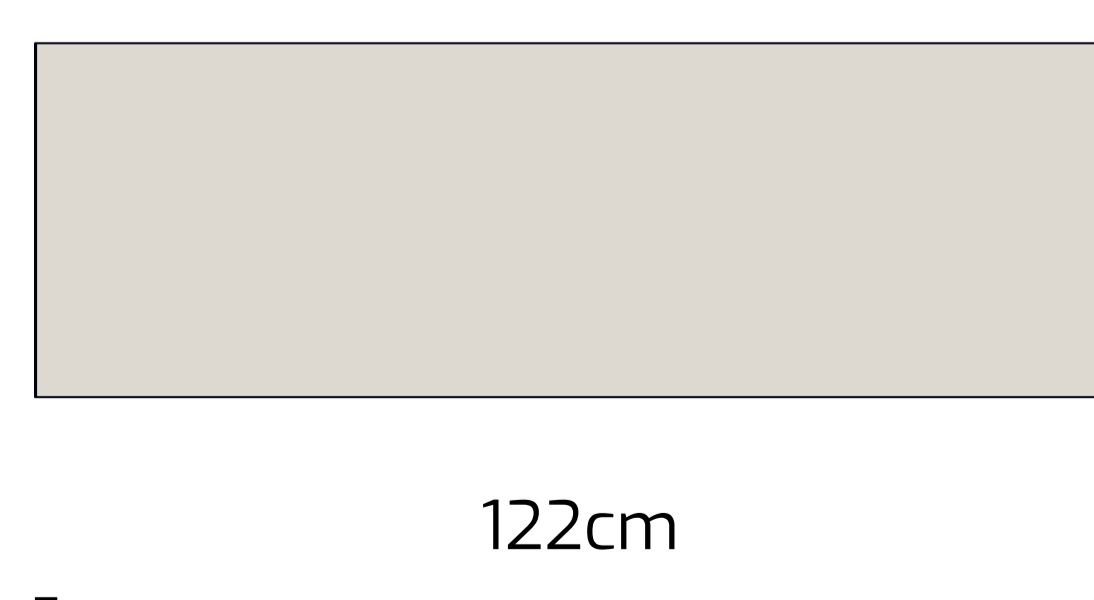
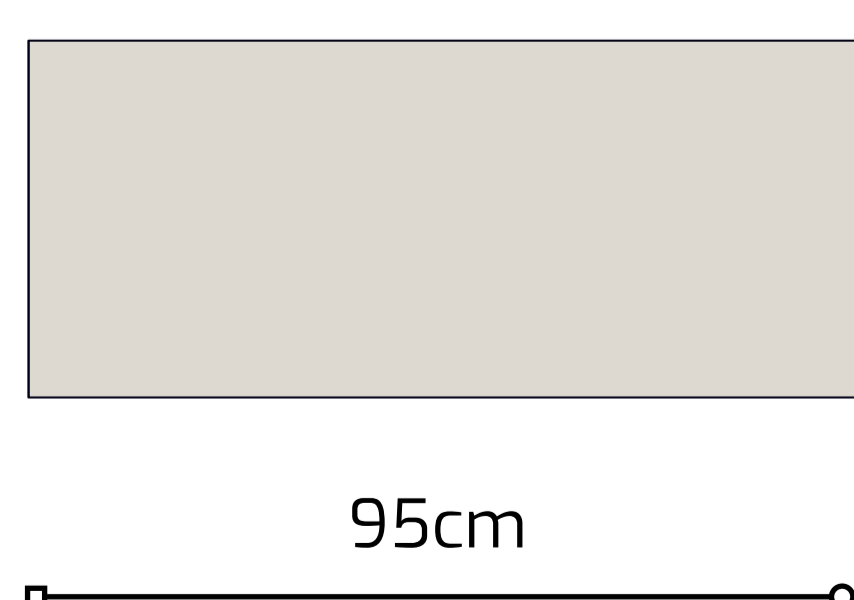
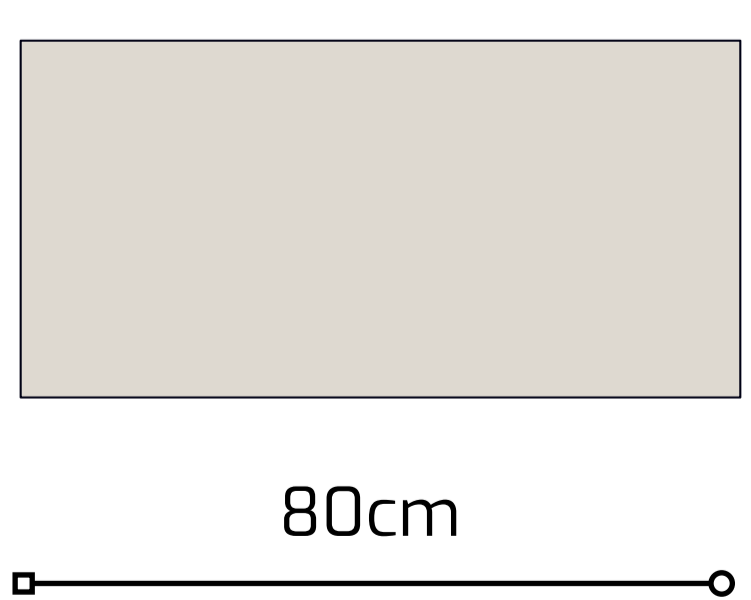
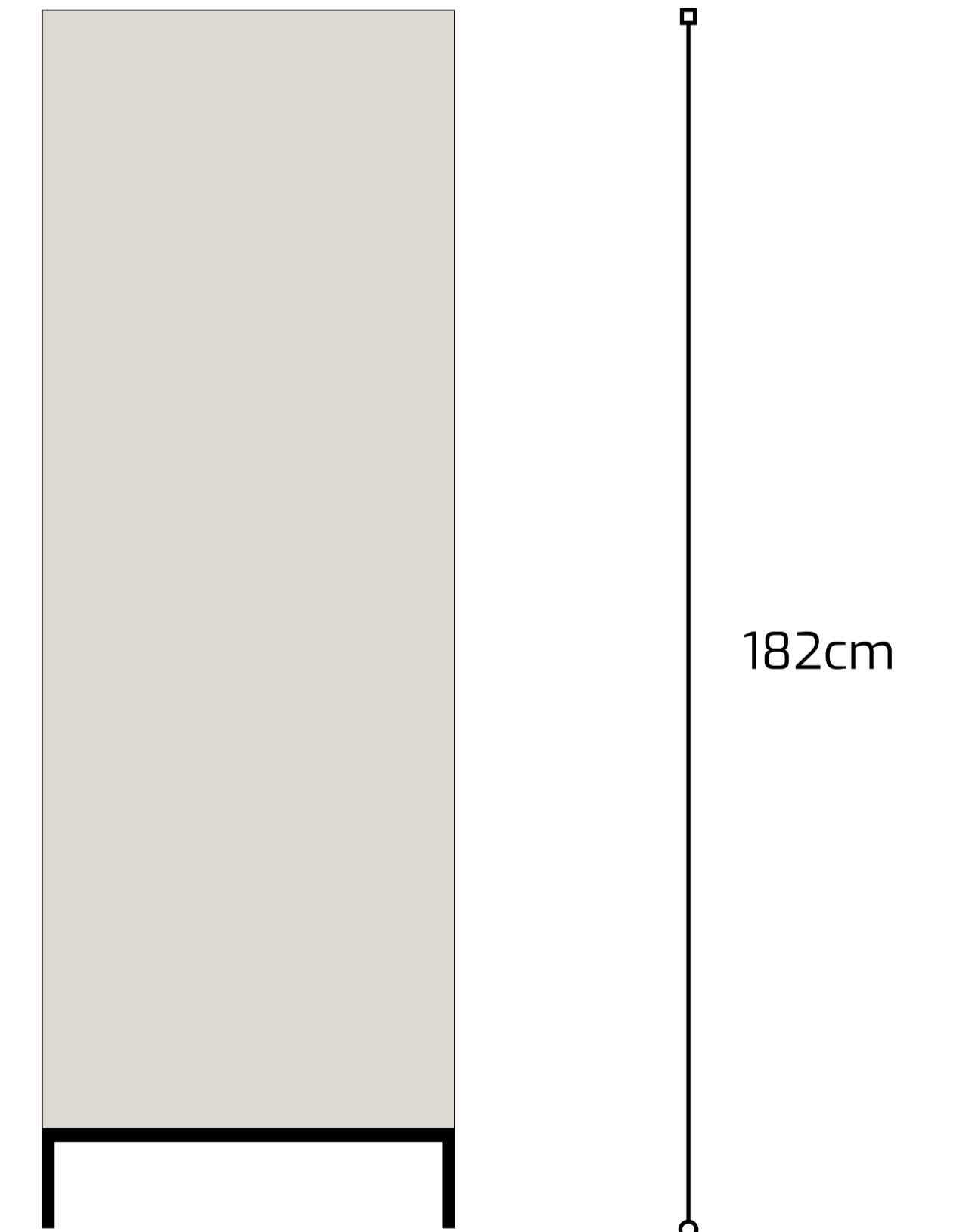
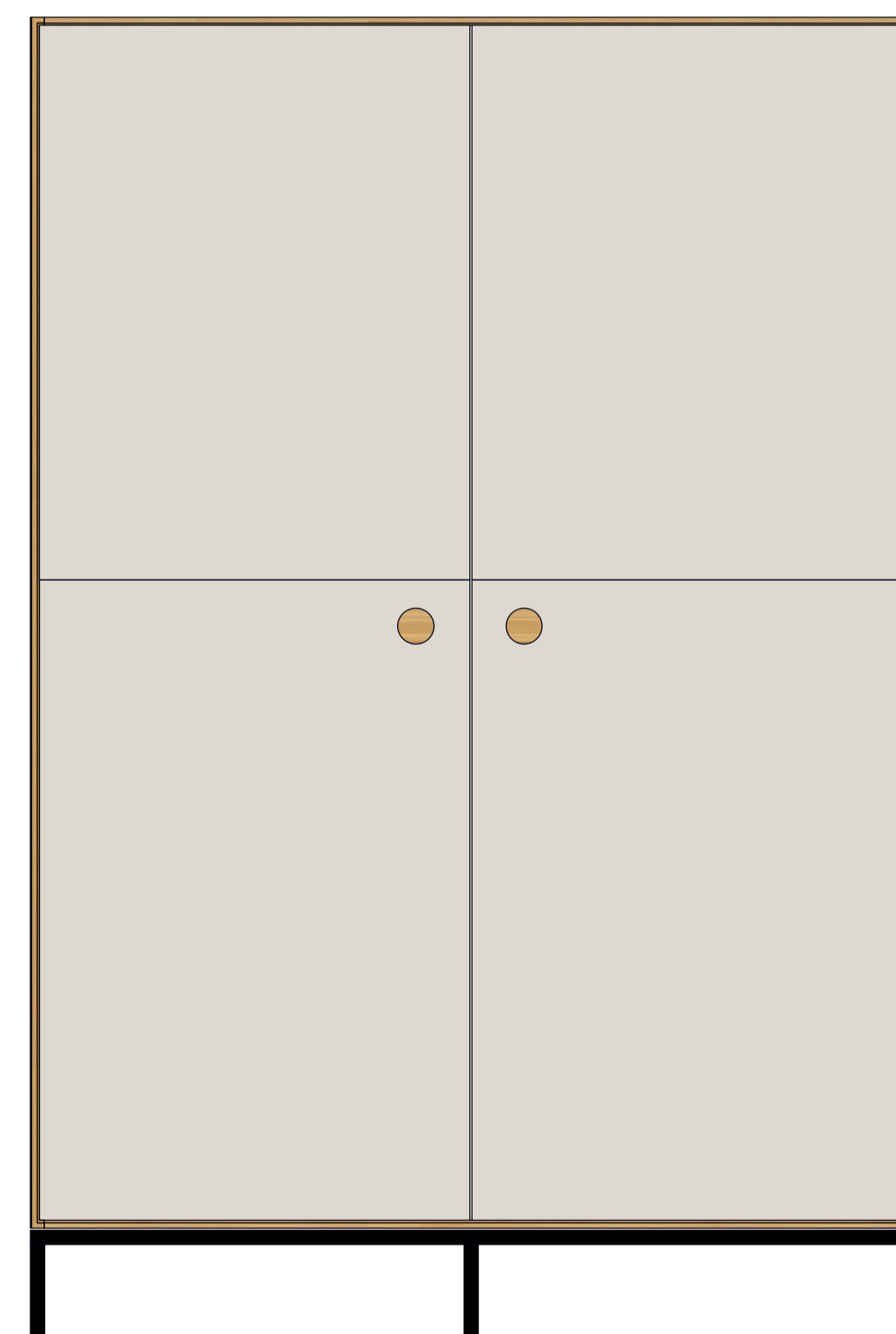
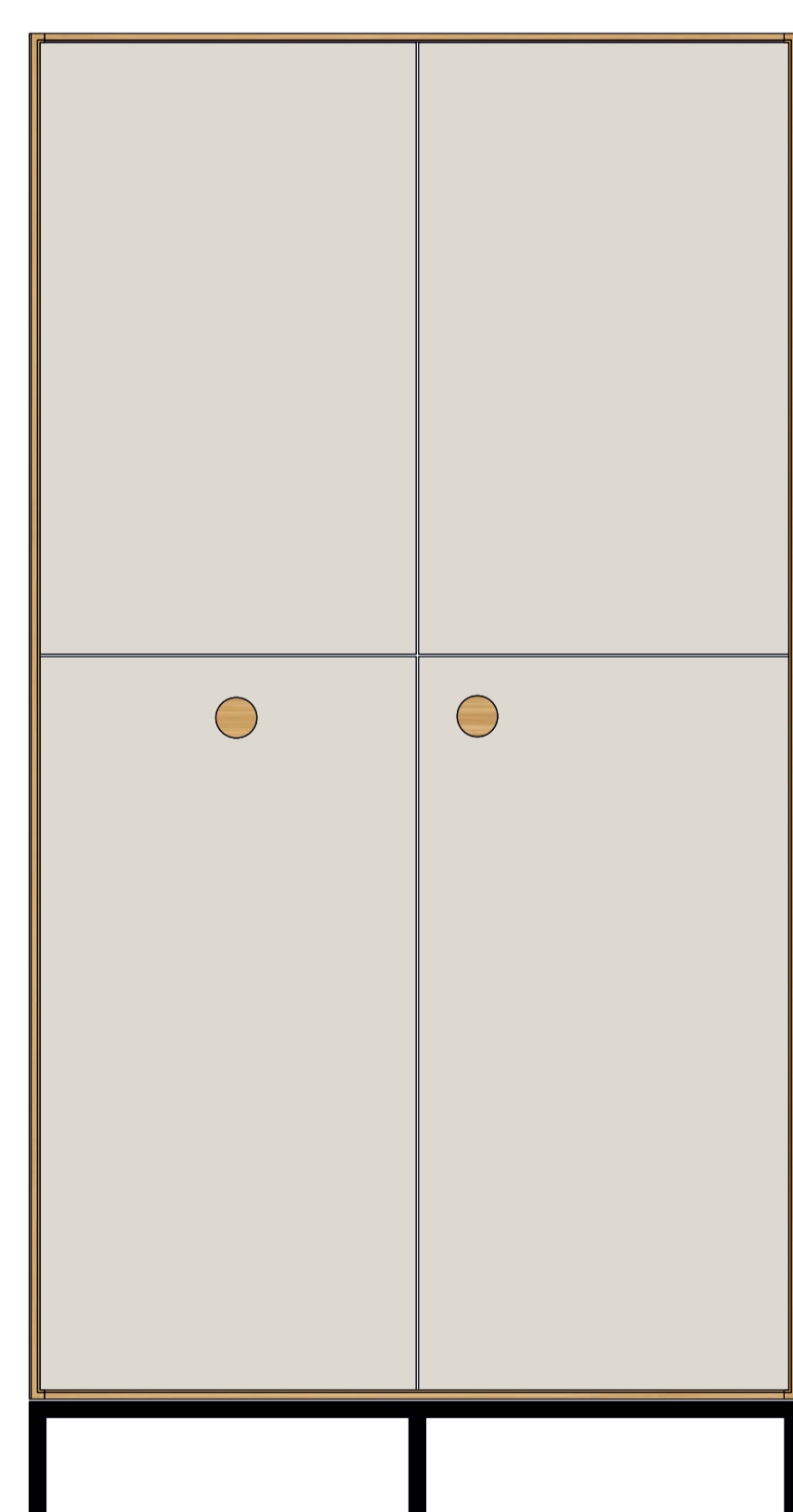
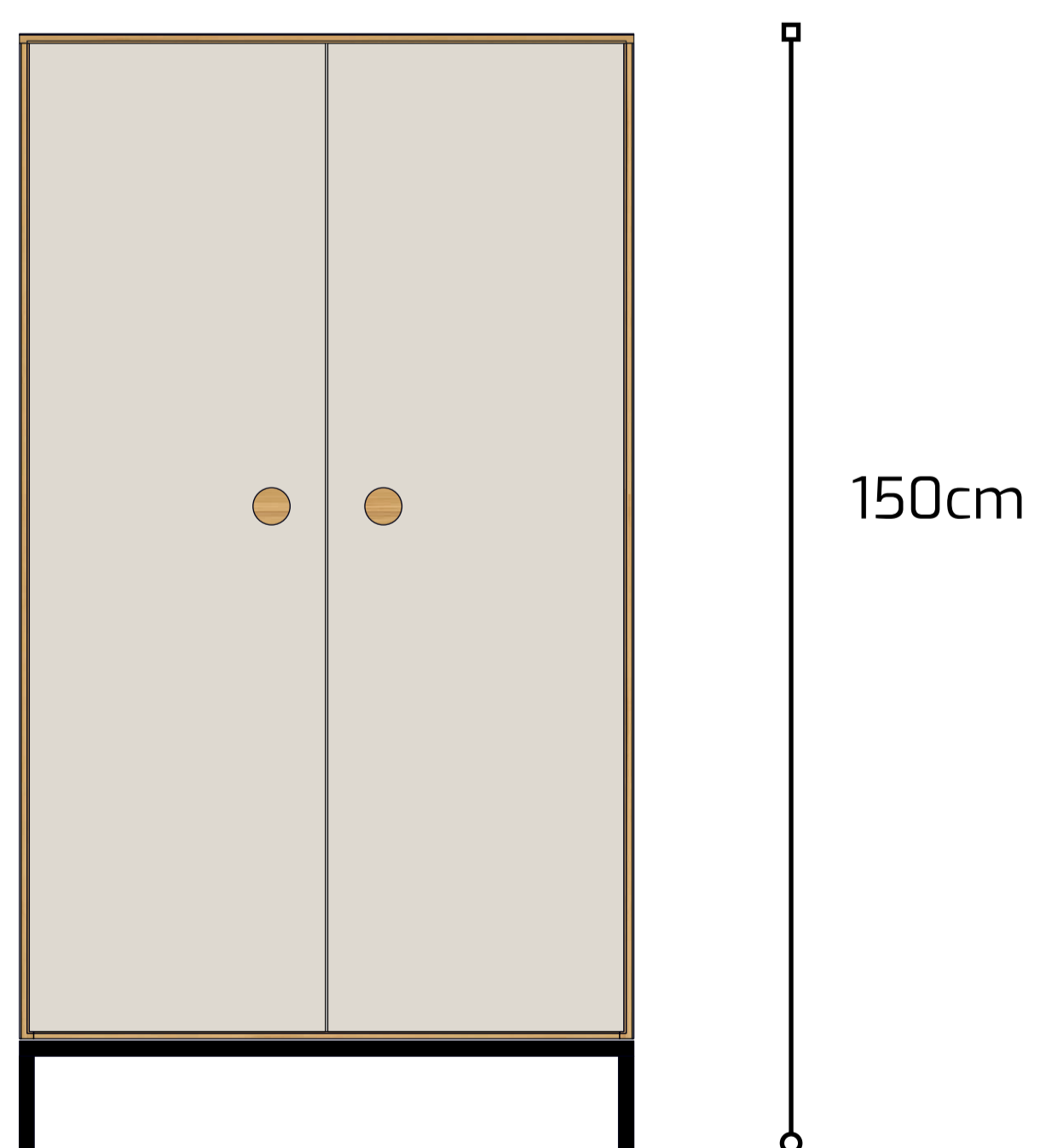

Shelf

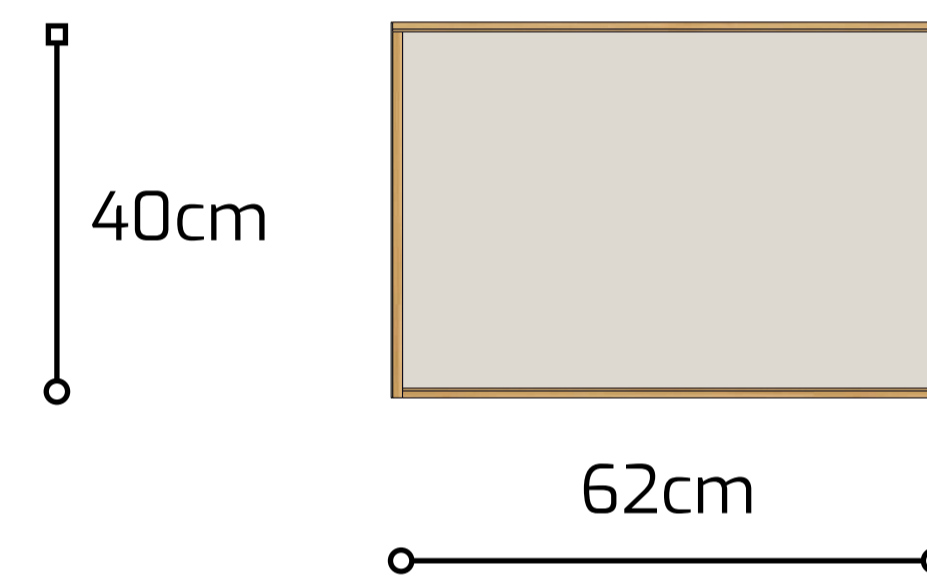
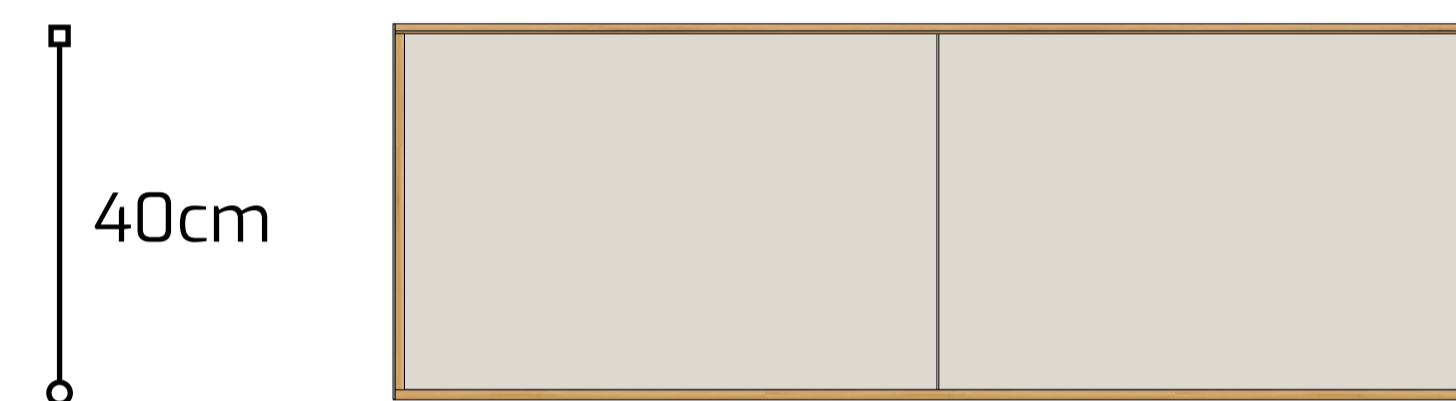
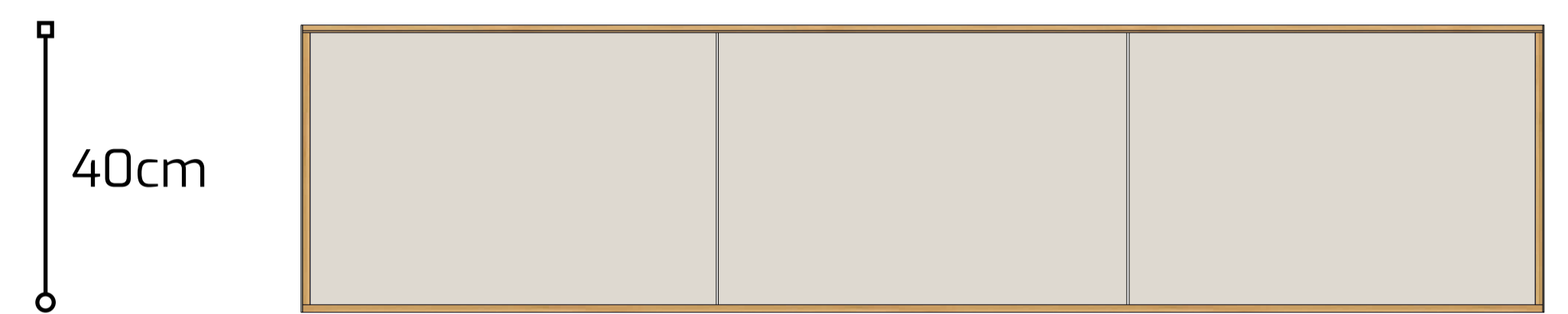
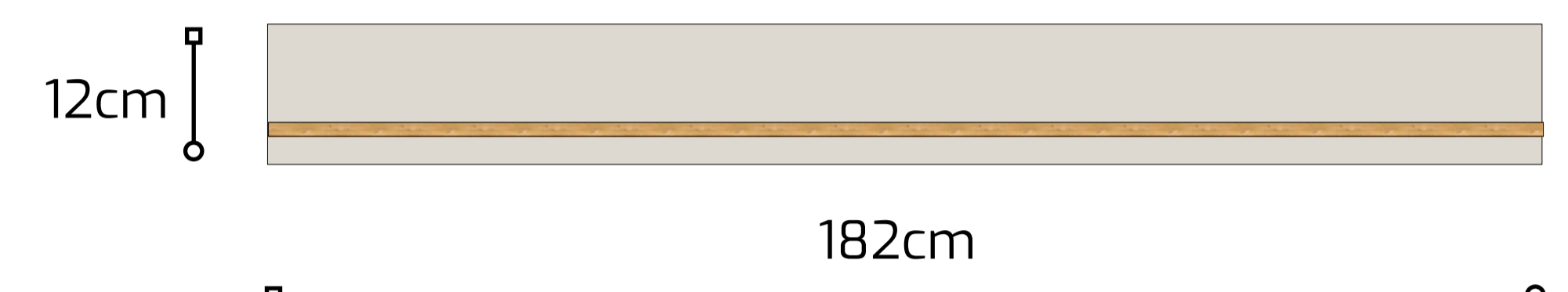

Wall Cabinets

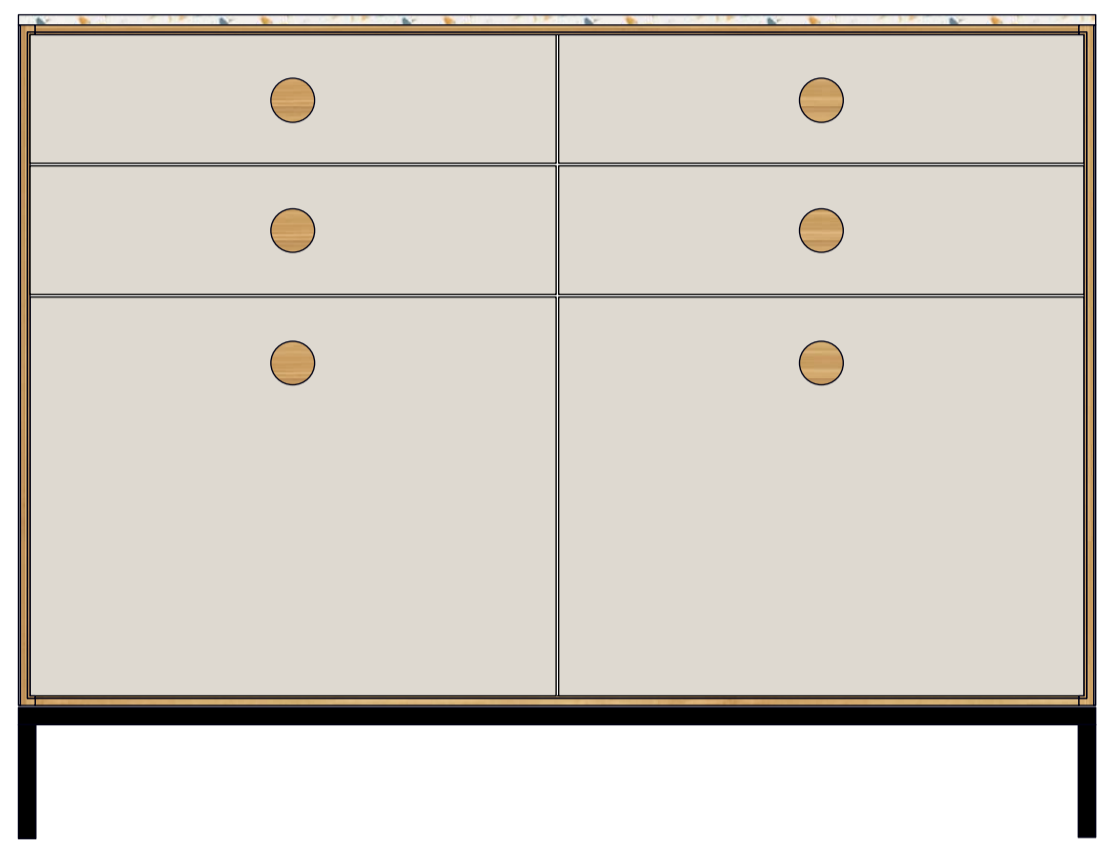

Base Unit 018

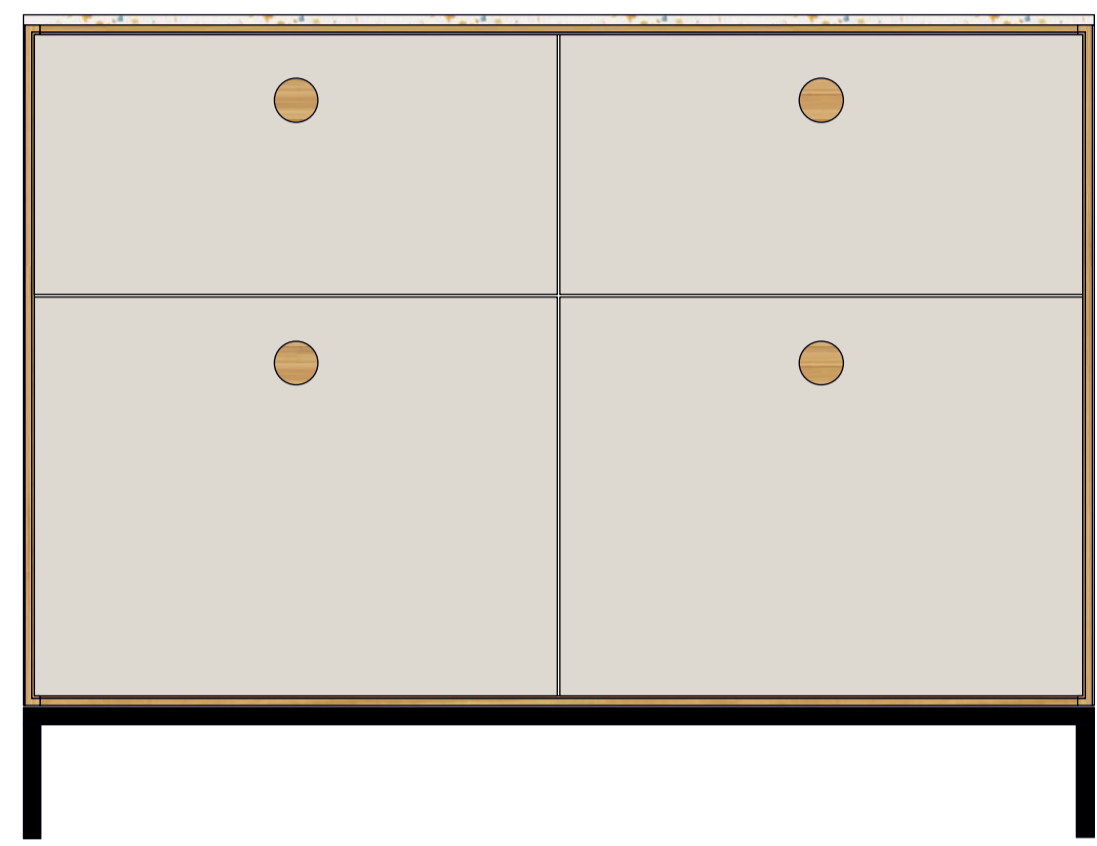
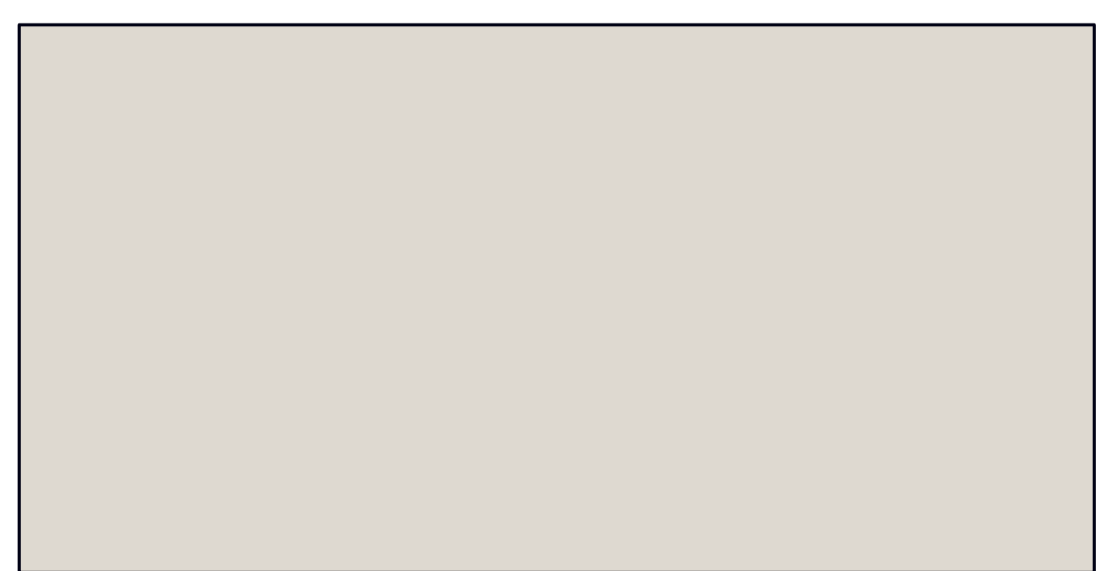

Base Unit 019

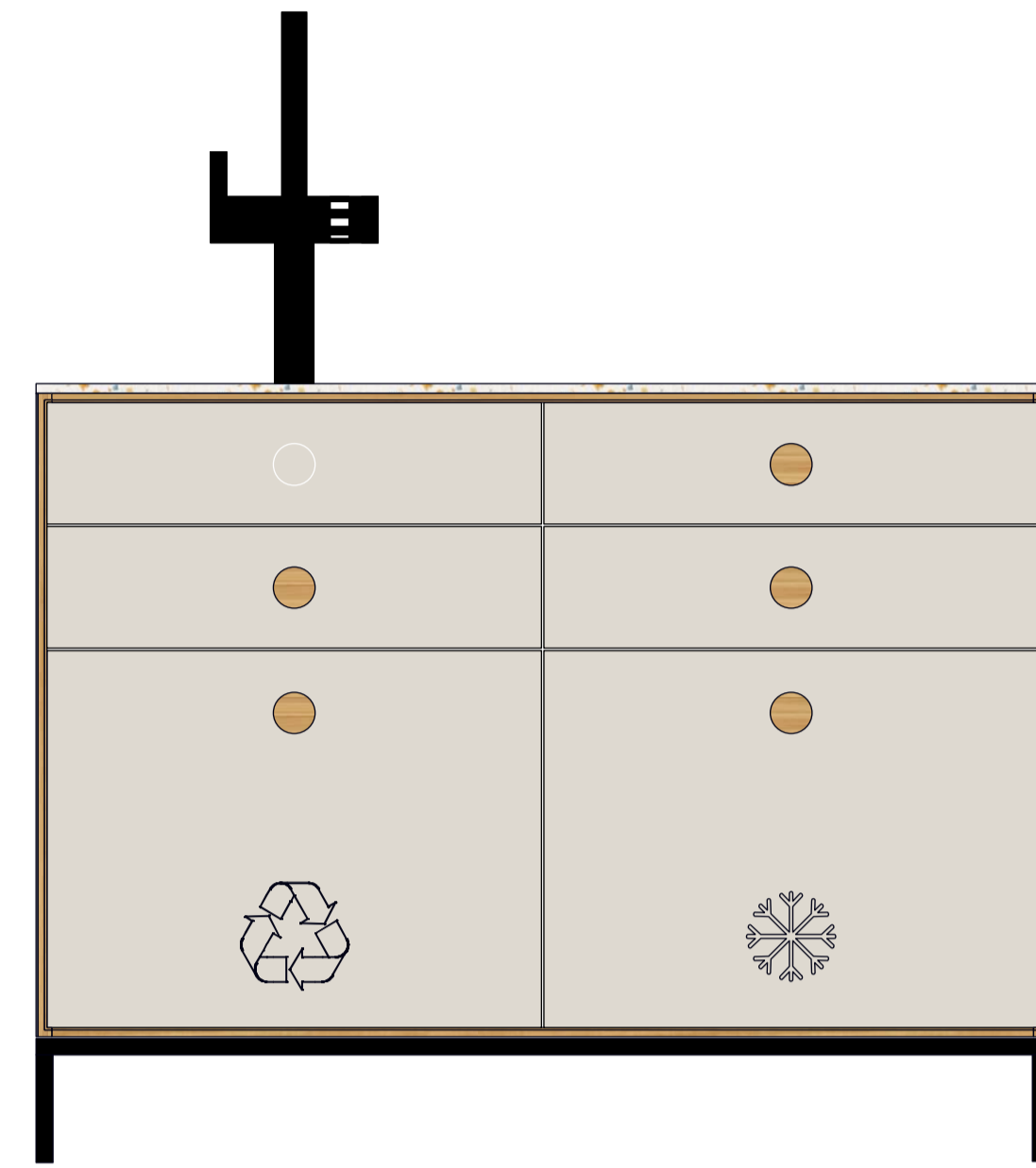
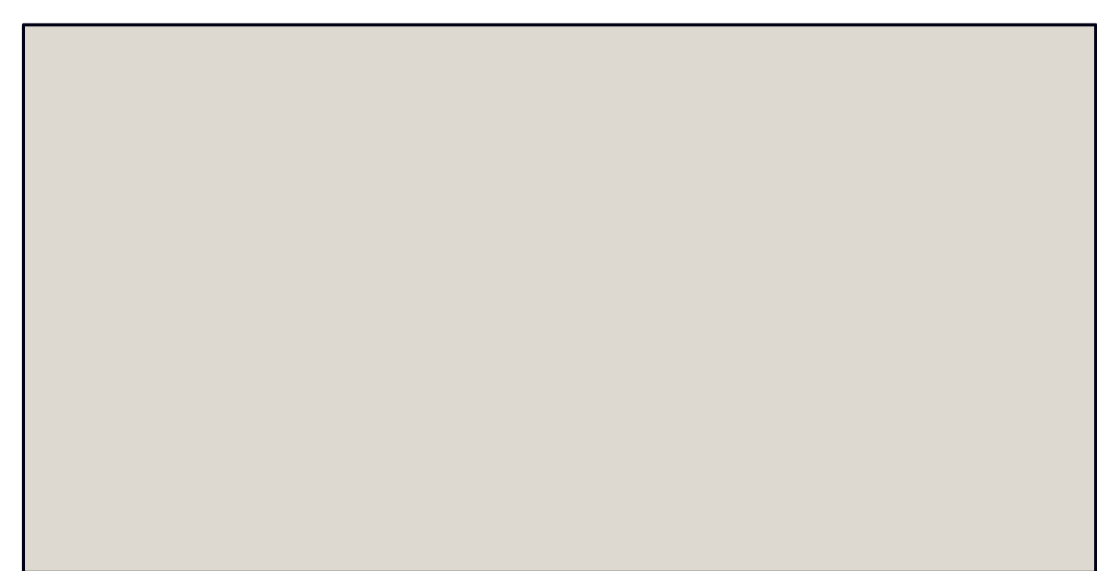

Base Unit 020

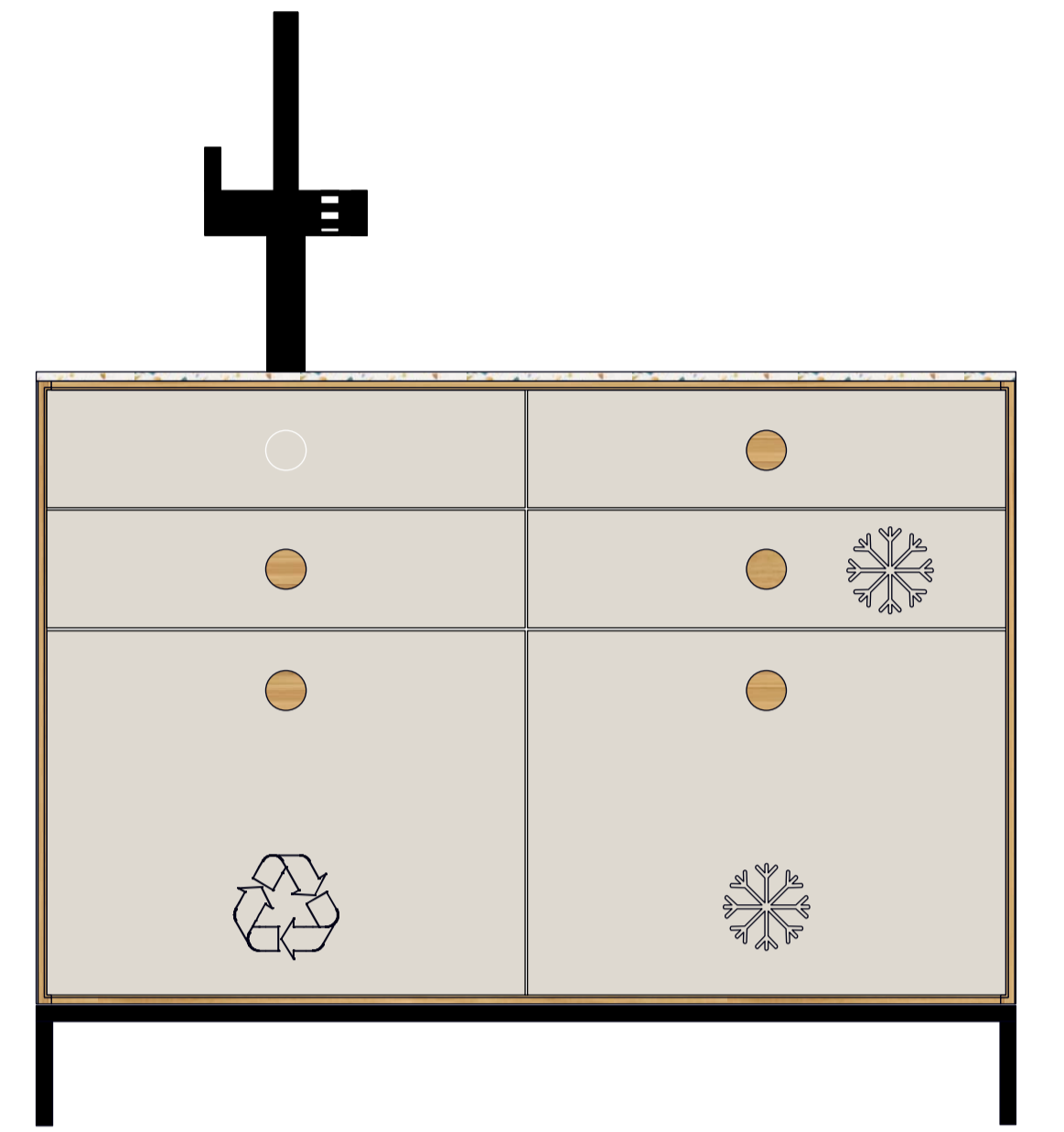
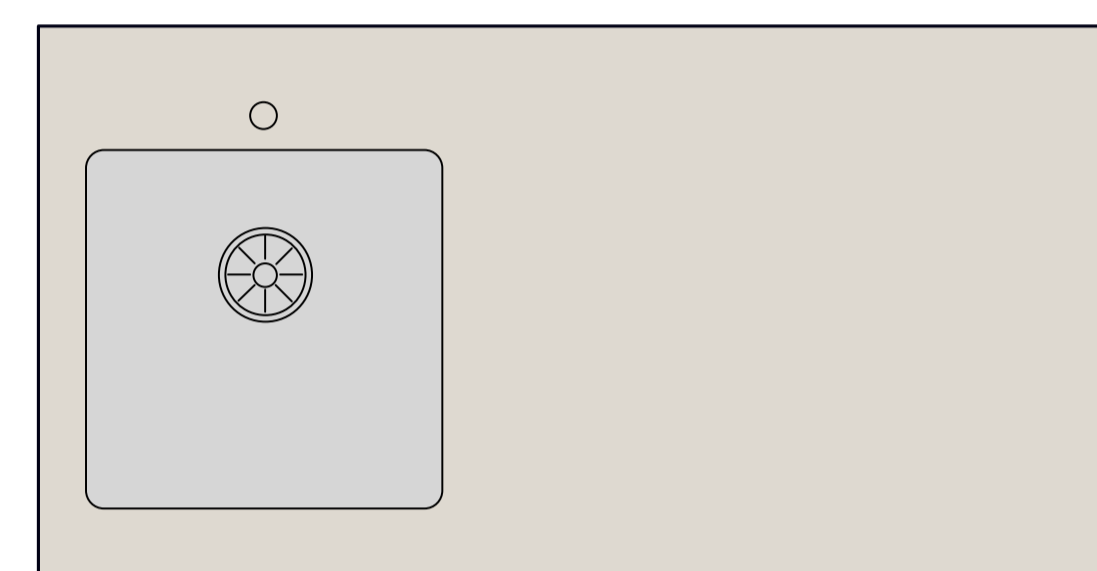

Base Unit 022

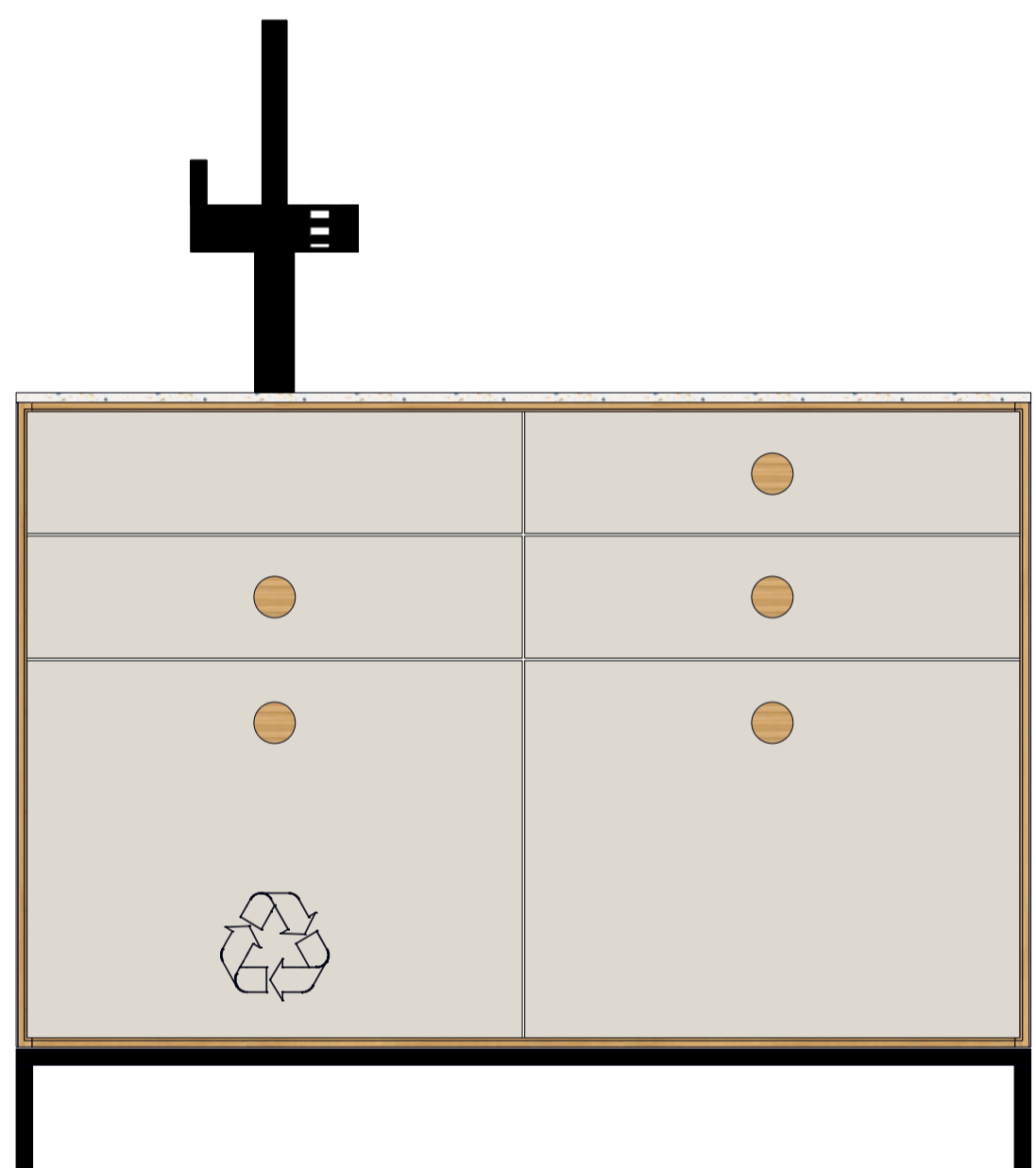
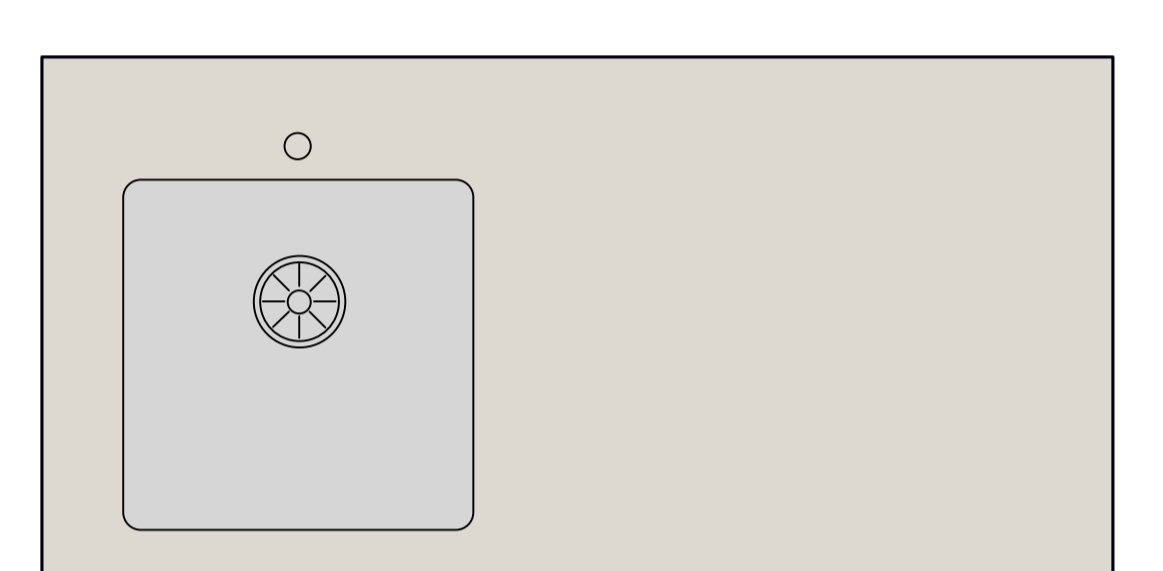

Base Unit 023

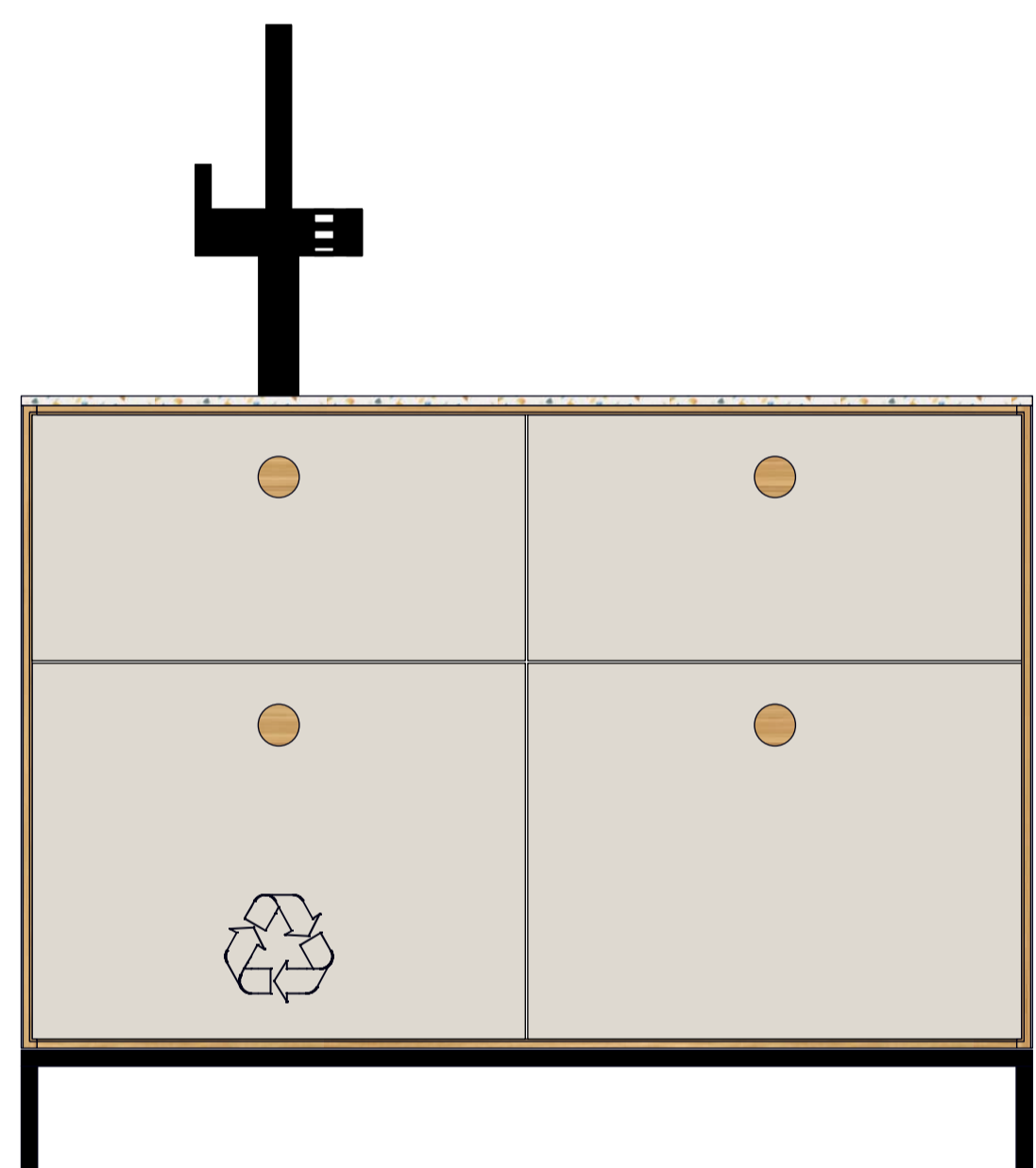
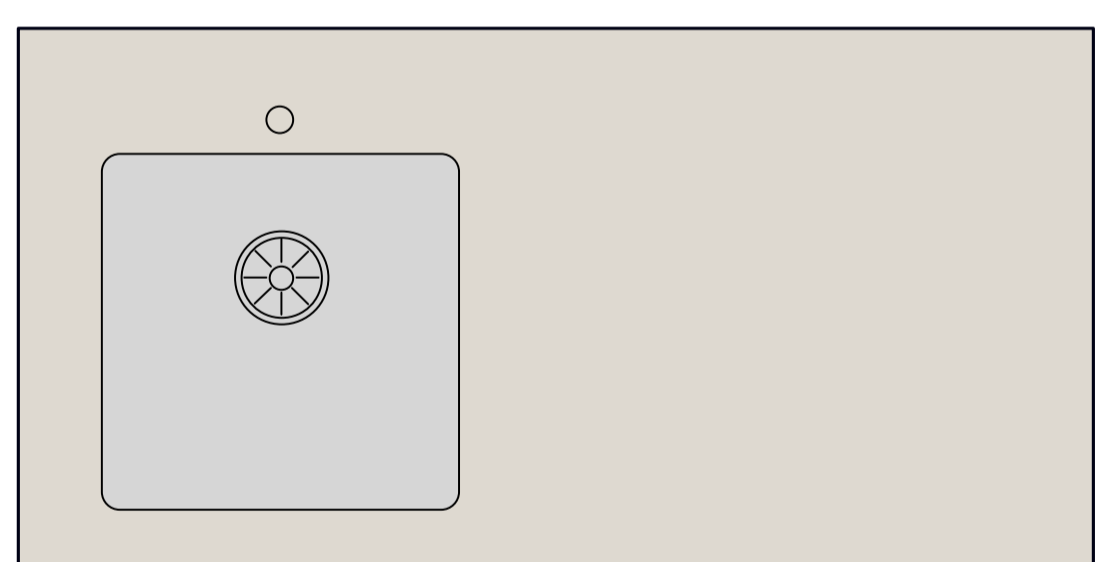

Base Unit 024

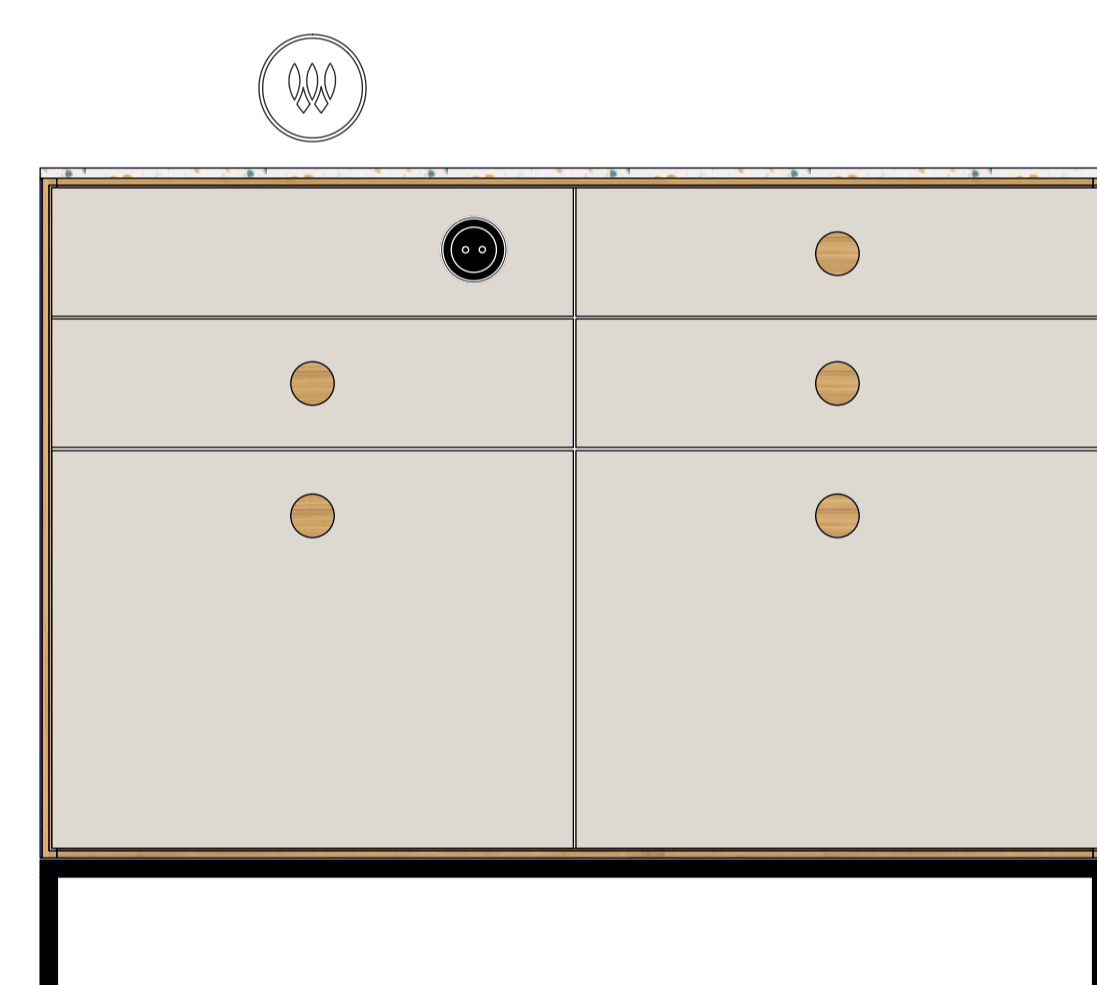
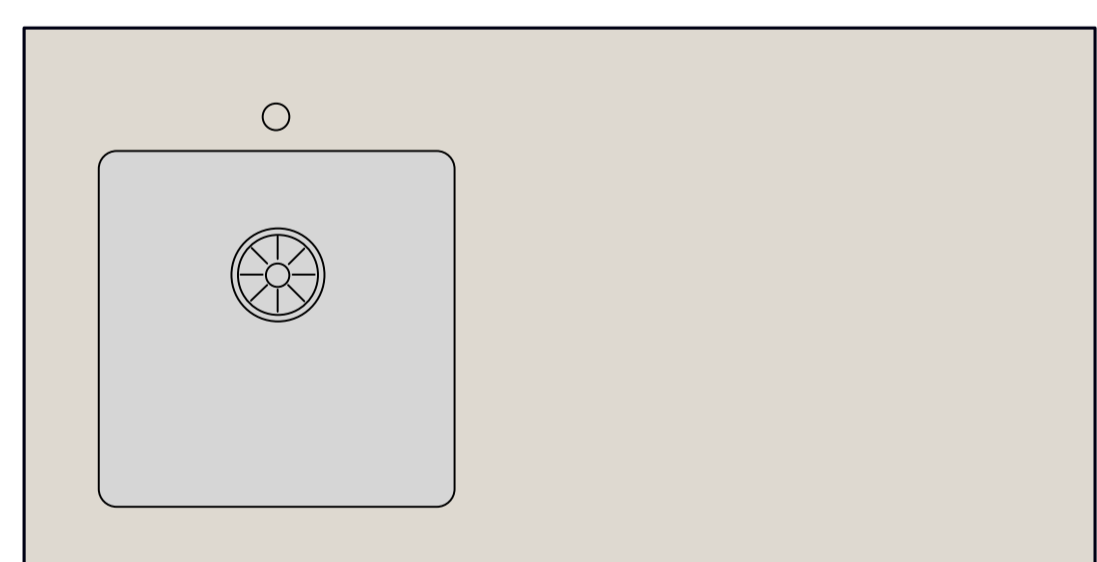

Base Unit 025

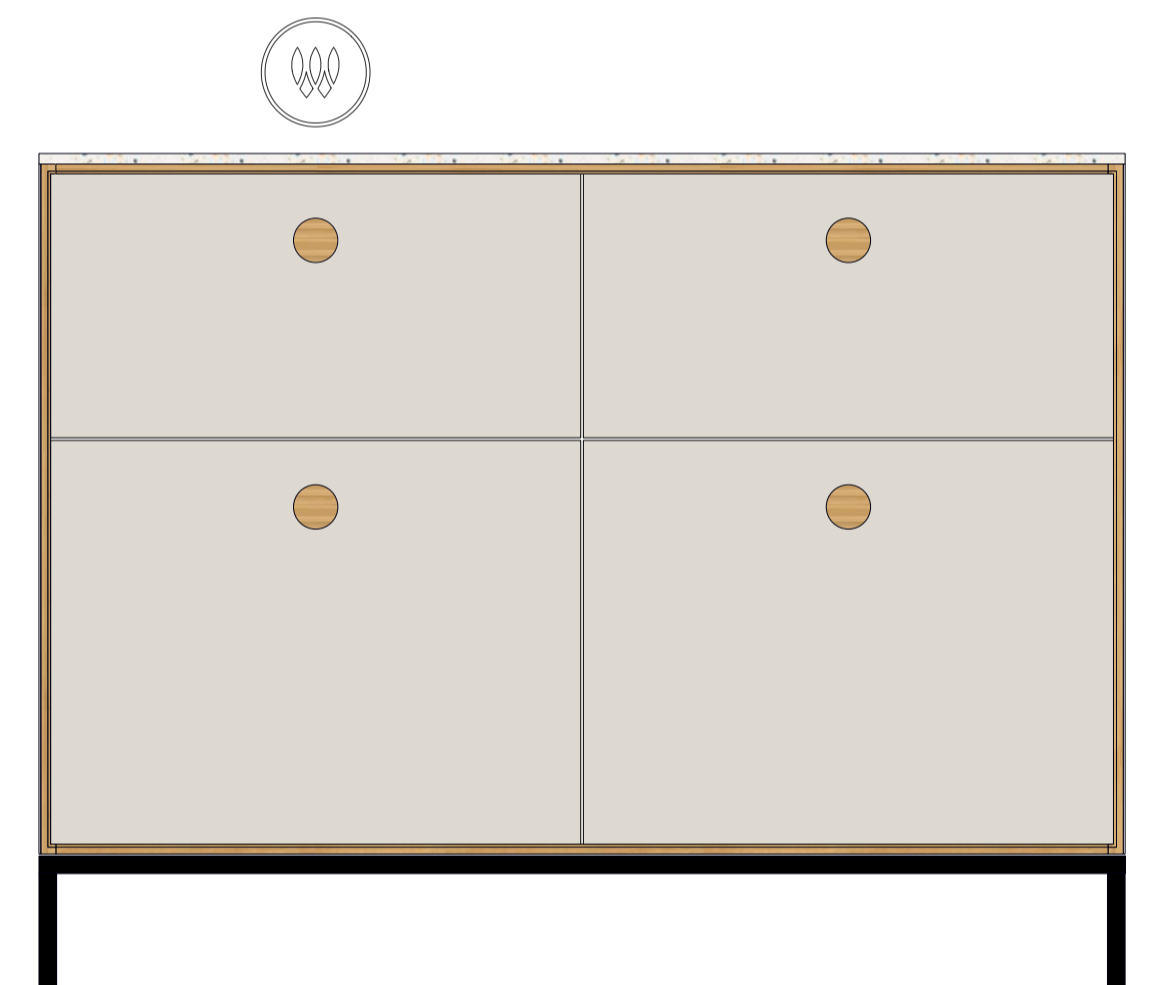
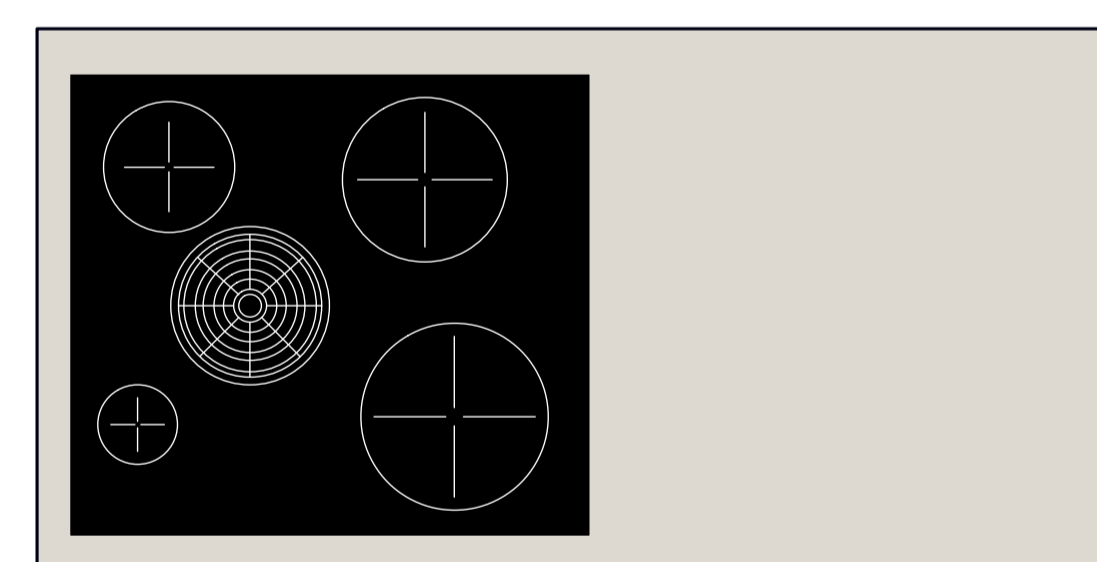

Base Unit 026

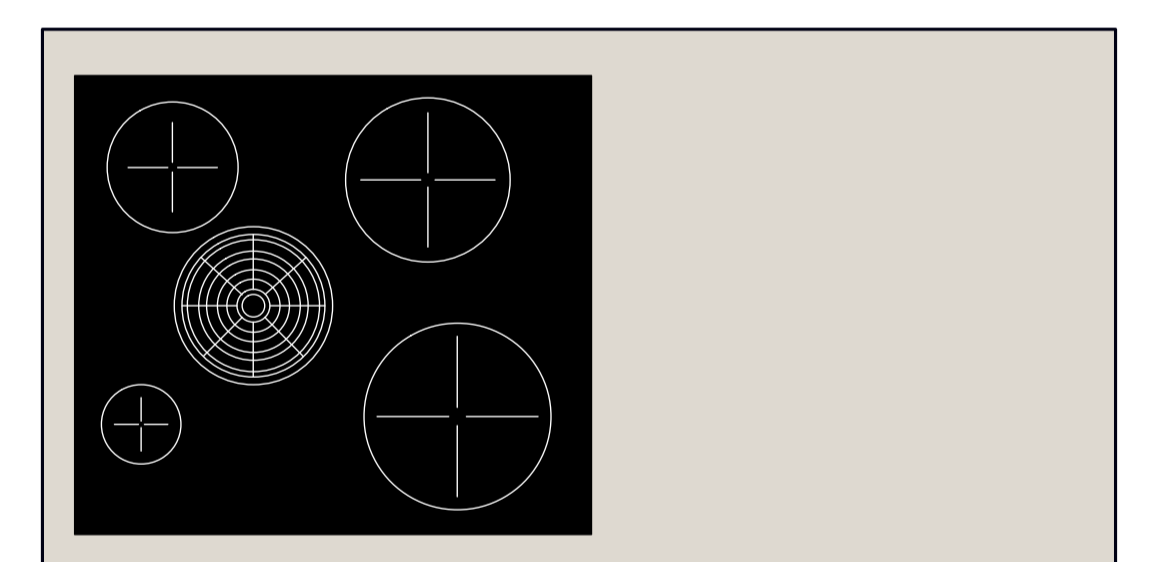

Base Unit 027

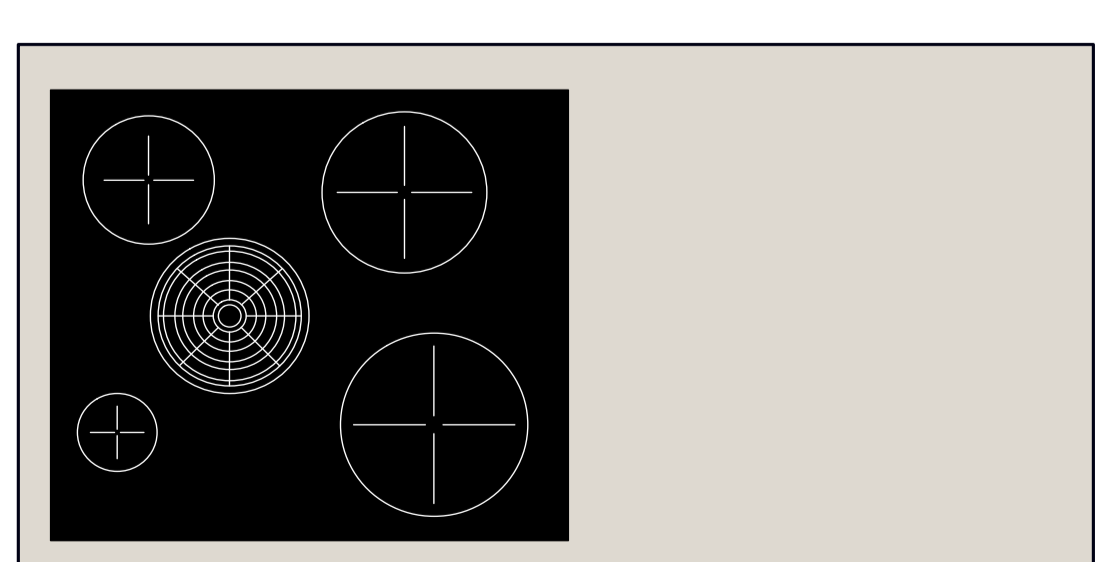

Base Unit 028

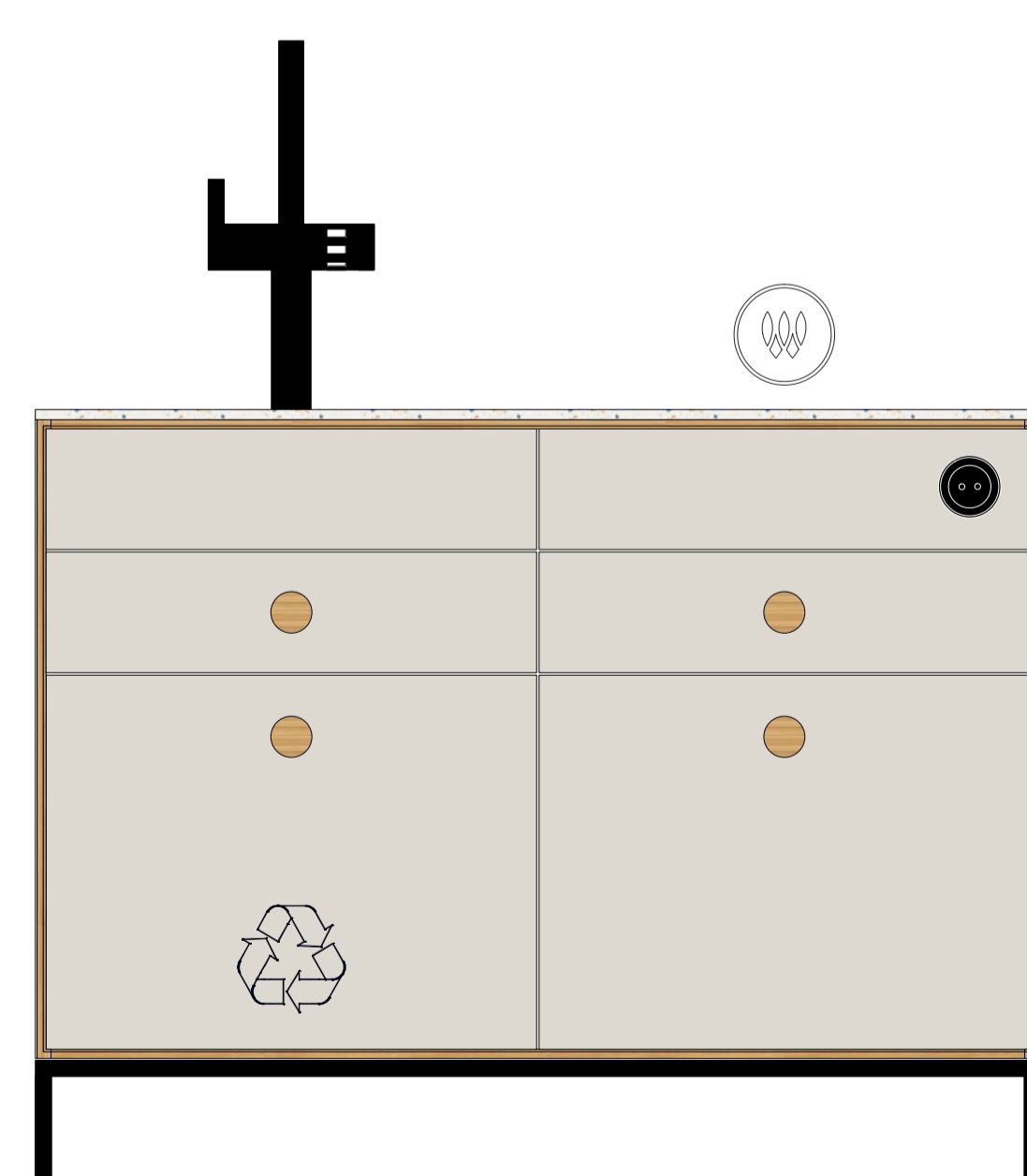
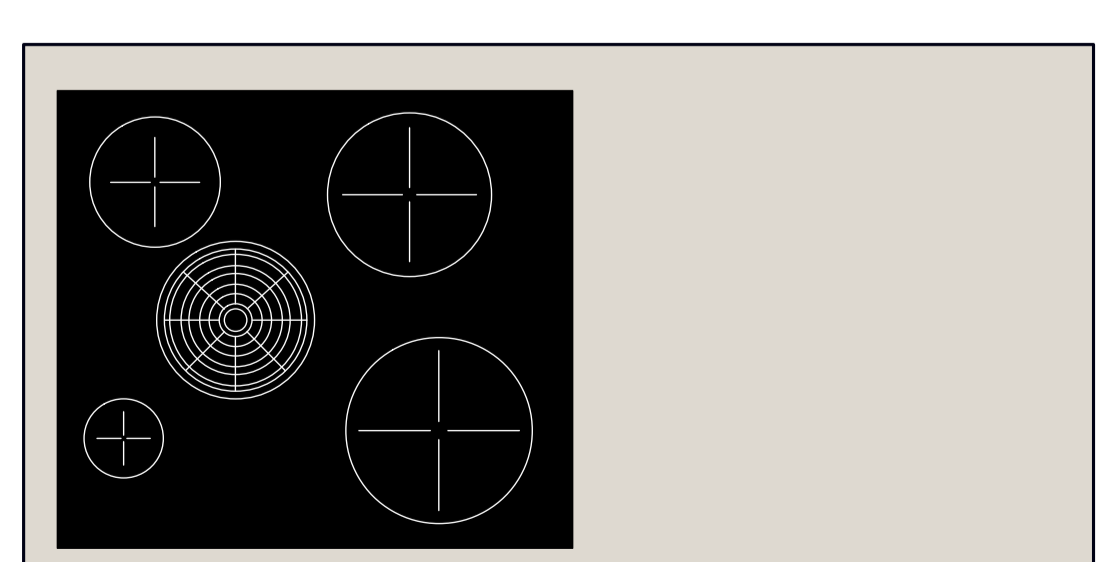

Base Unit 029

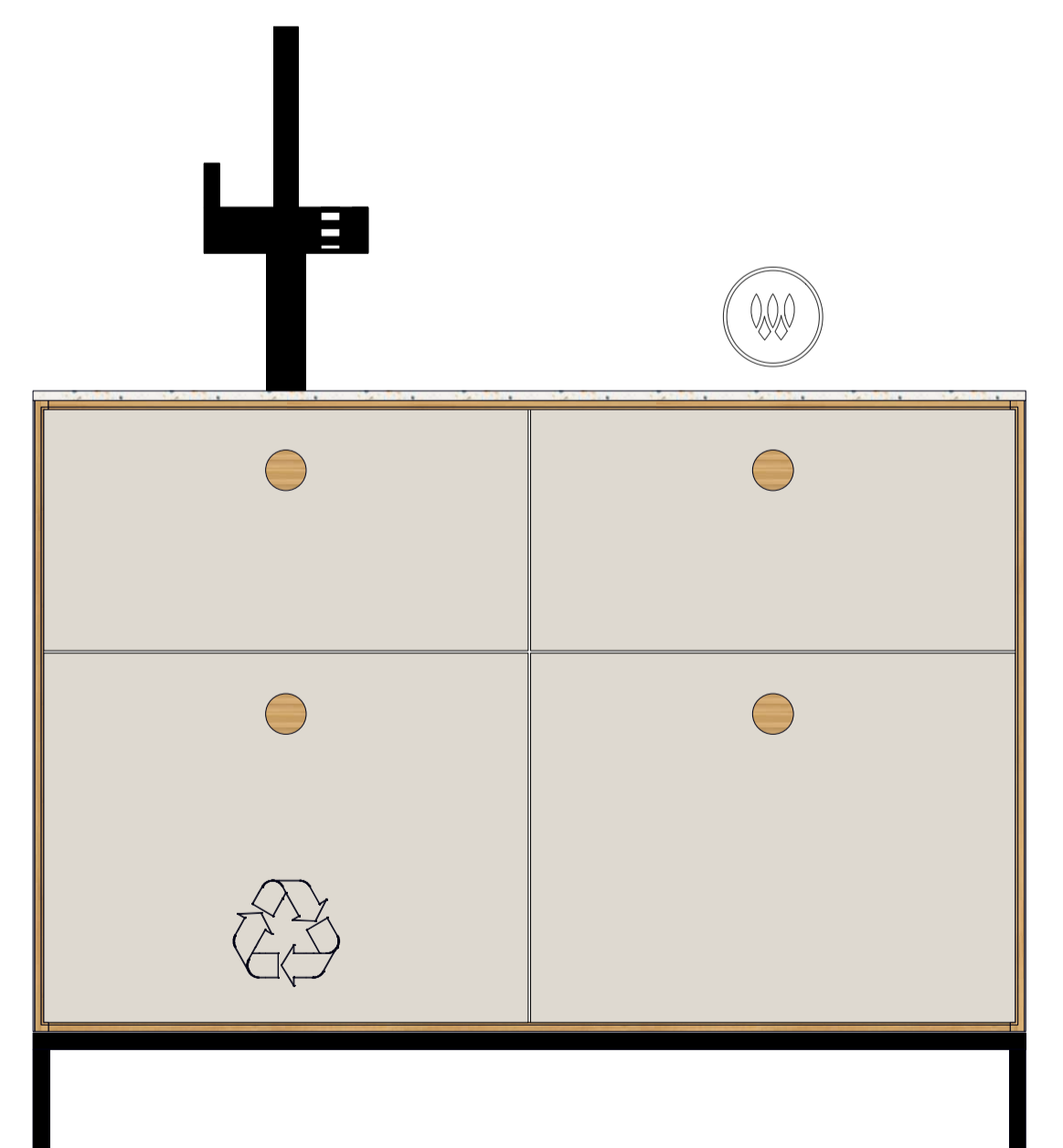
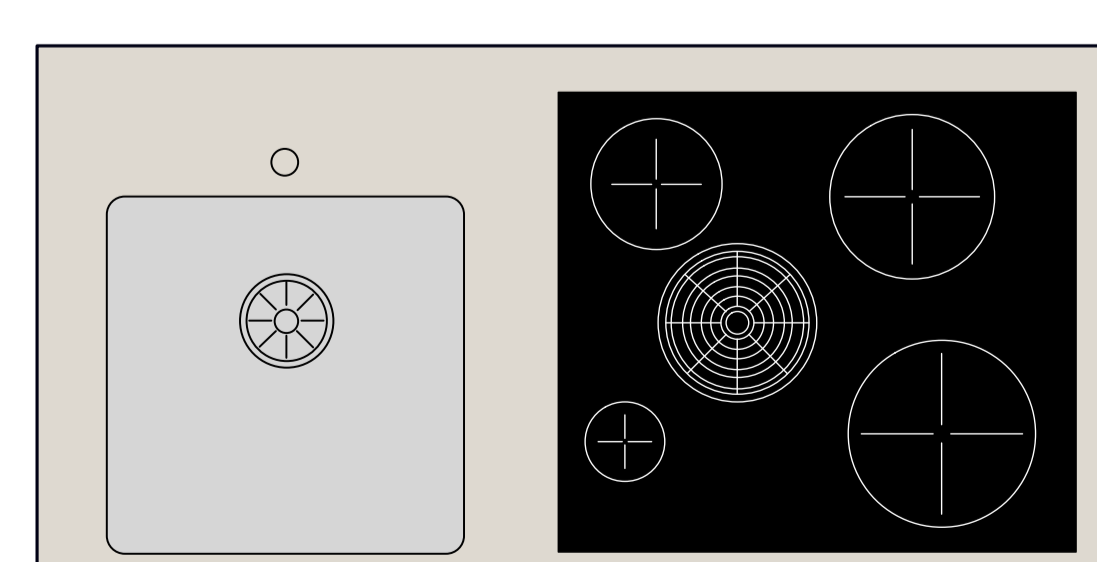

Base Unit 030

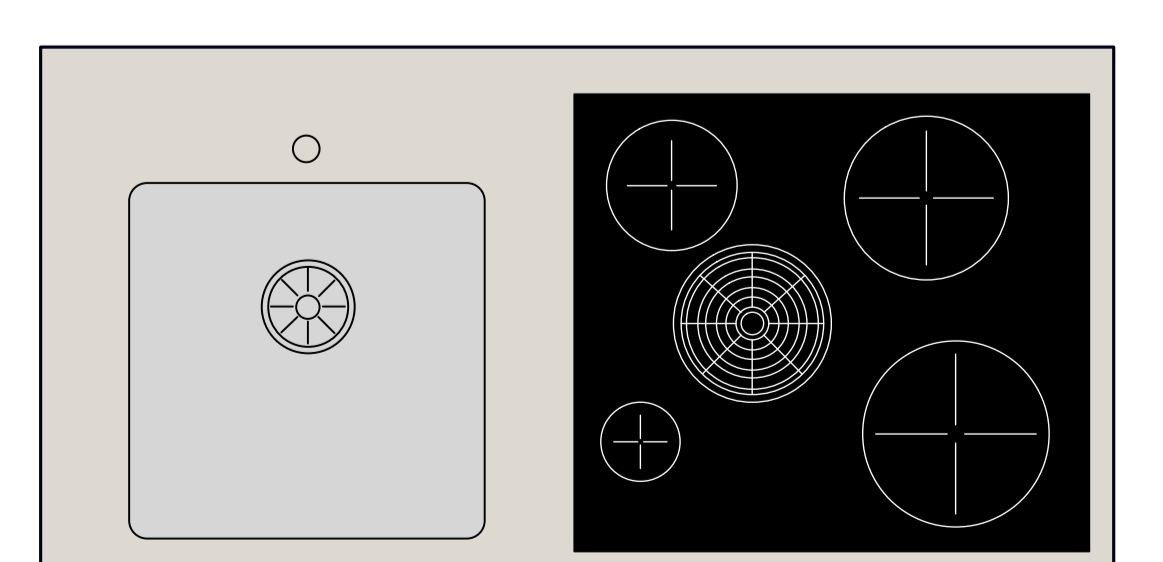

# BASE UNITS 180 cm

Legende:  Kochfeld mit Abzug,  Geschirrspüler,  Mülltrennsystem,  Kühlschrank,  Backofen,  Weinkühlchrank,

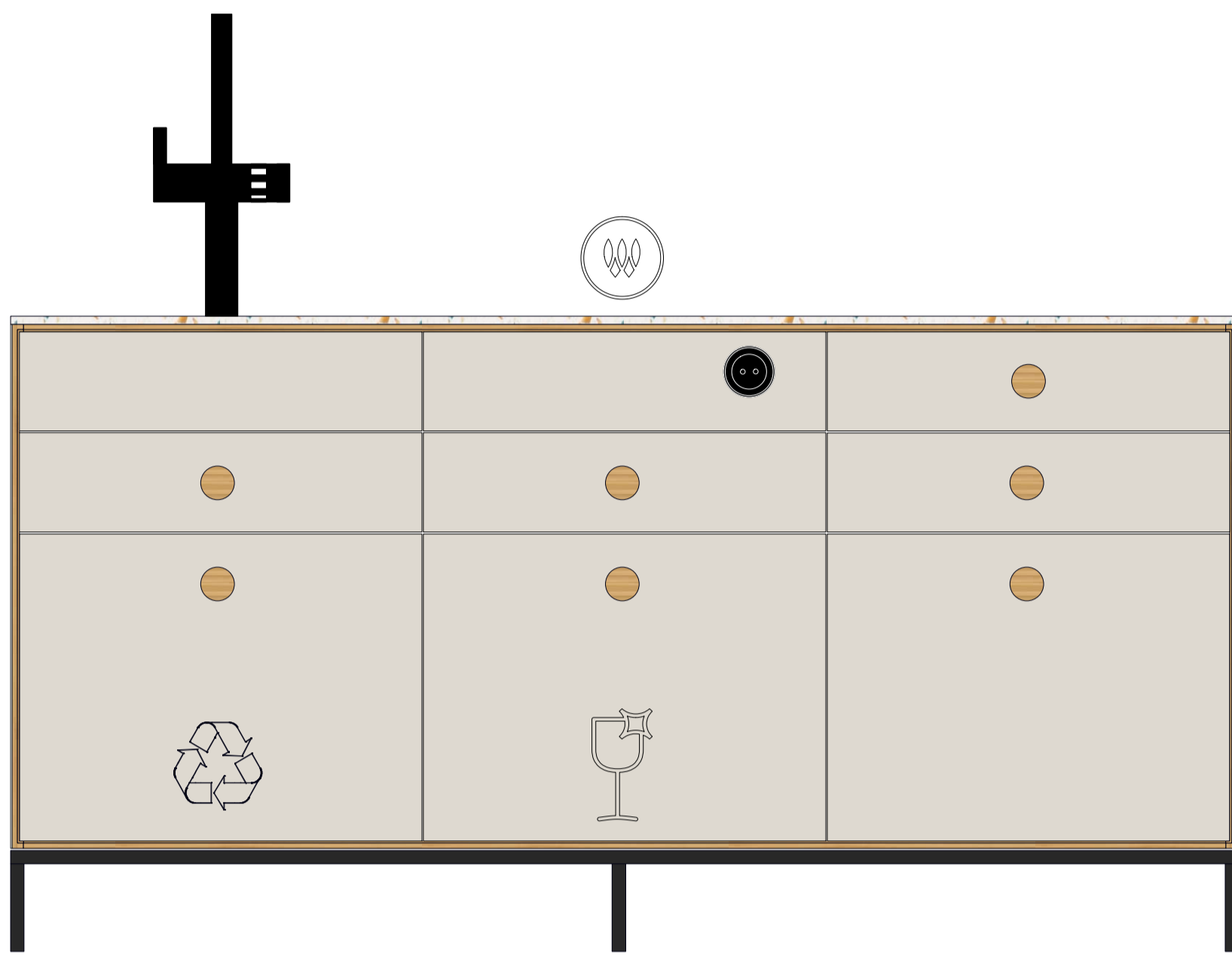

Base Unit 01

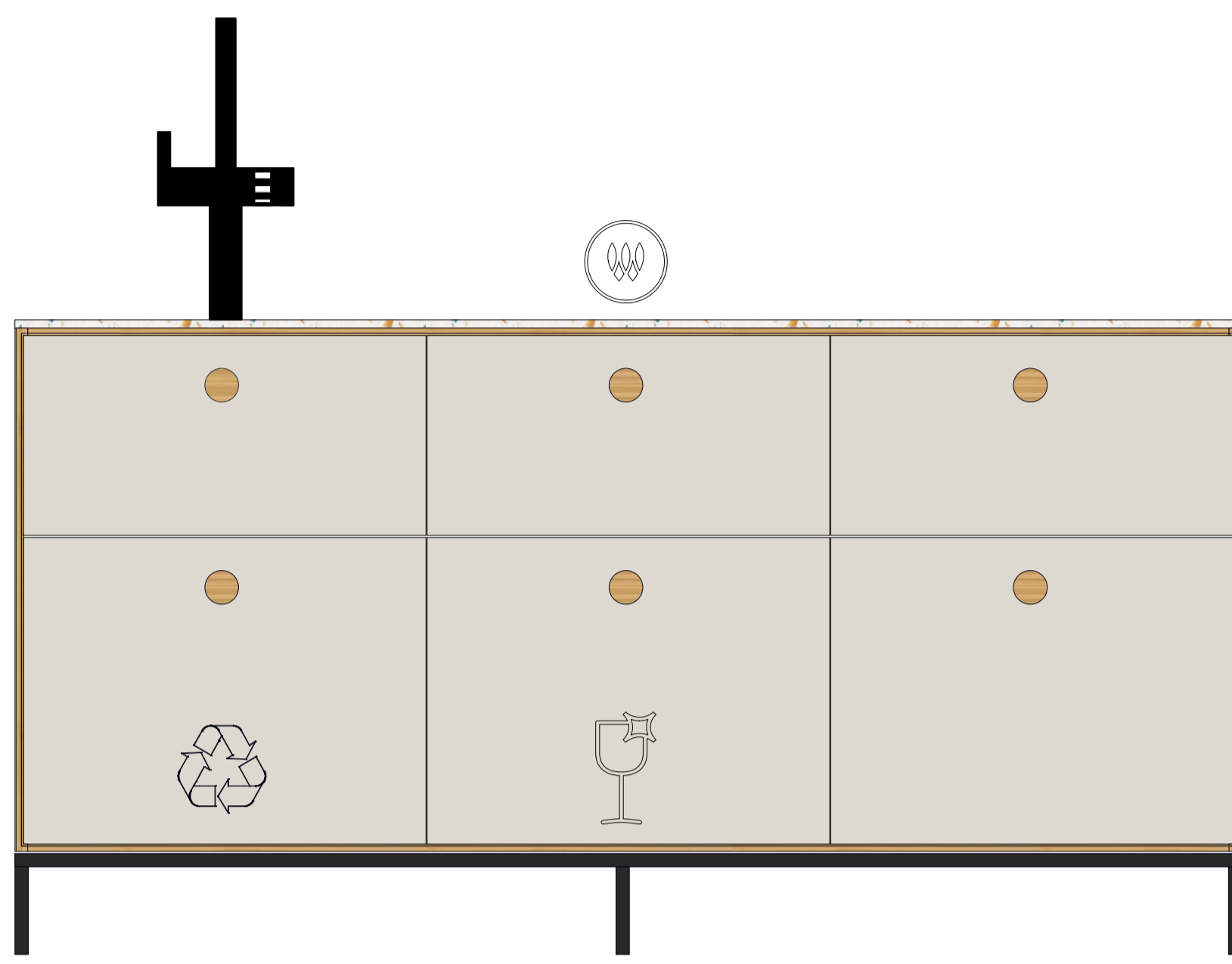
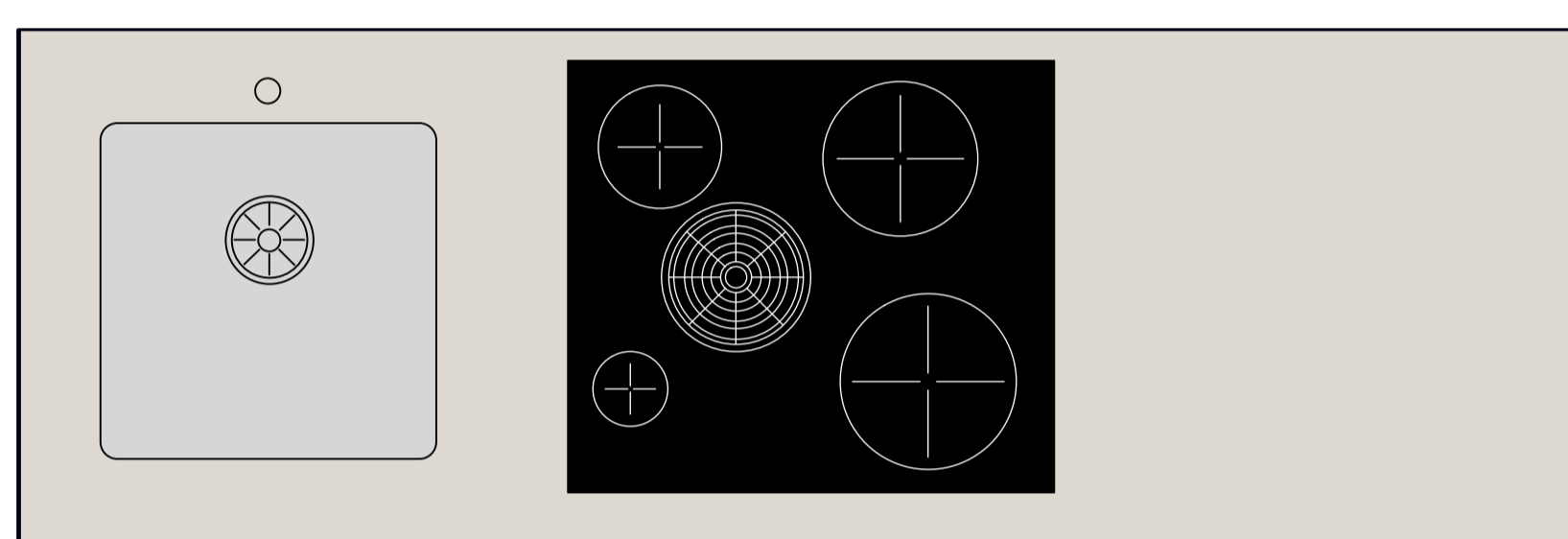

Base Unit 02

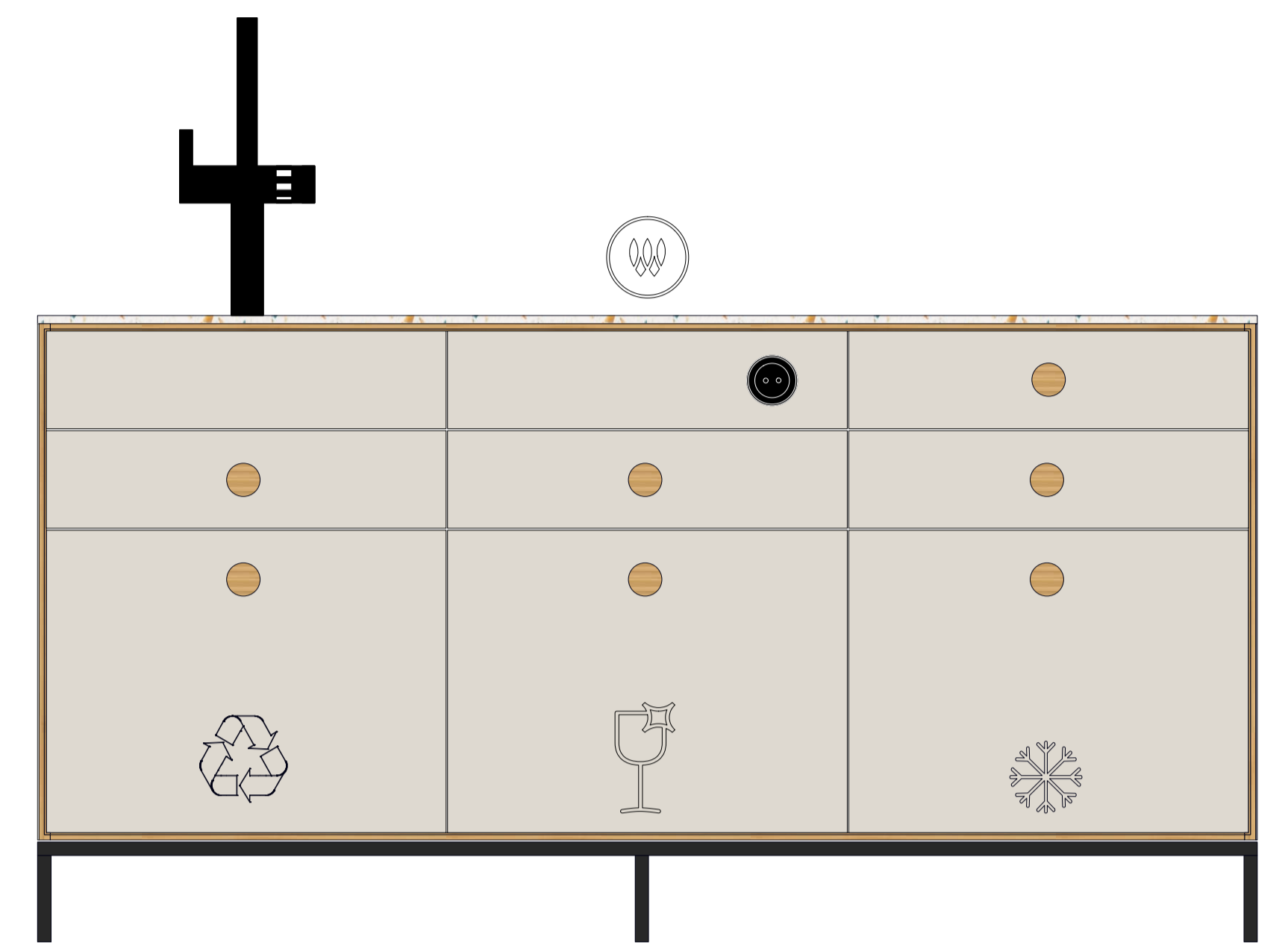
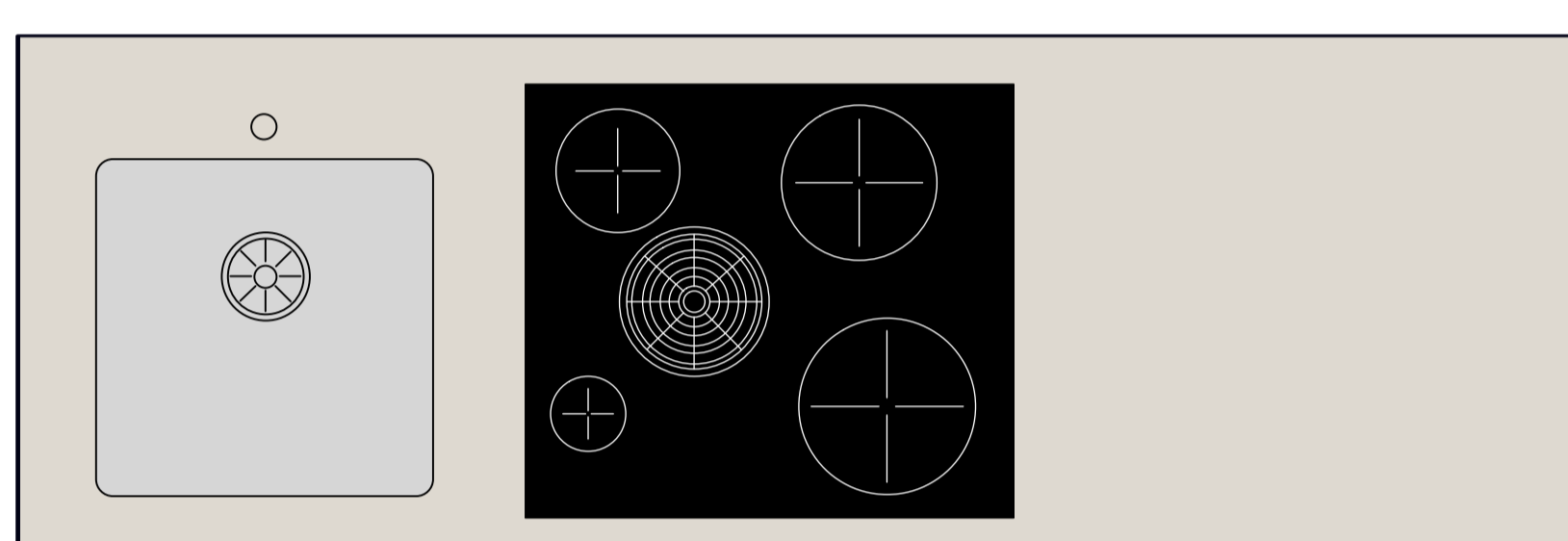

Base Unit 03

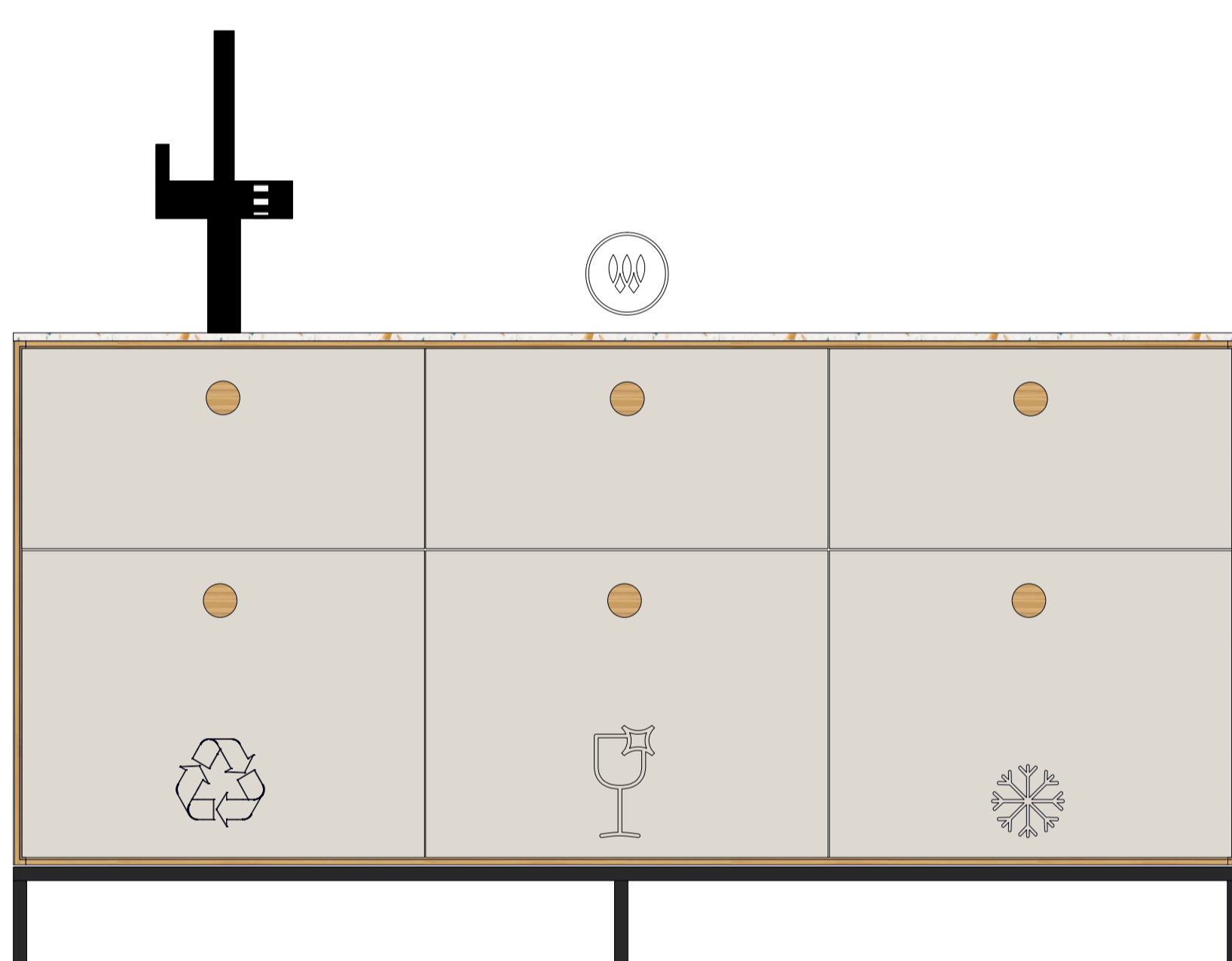
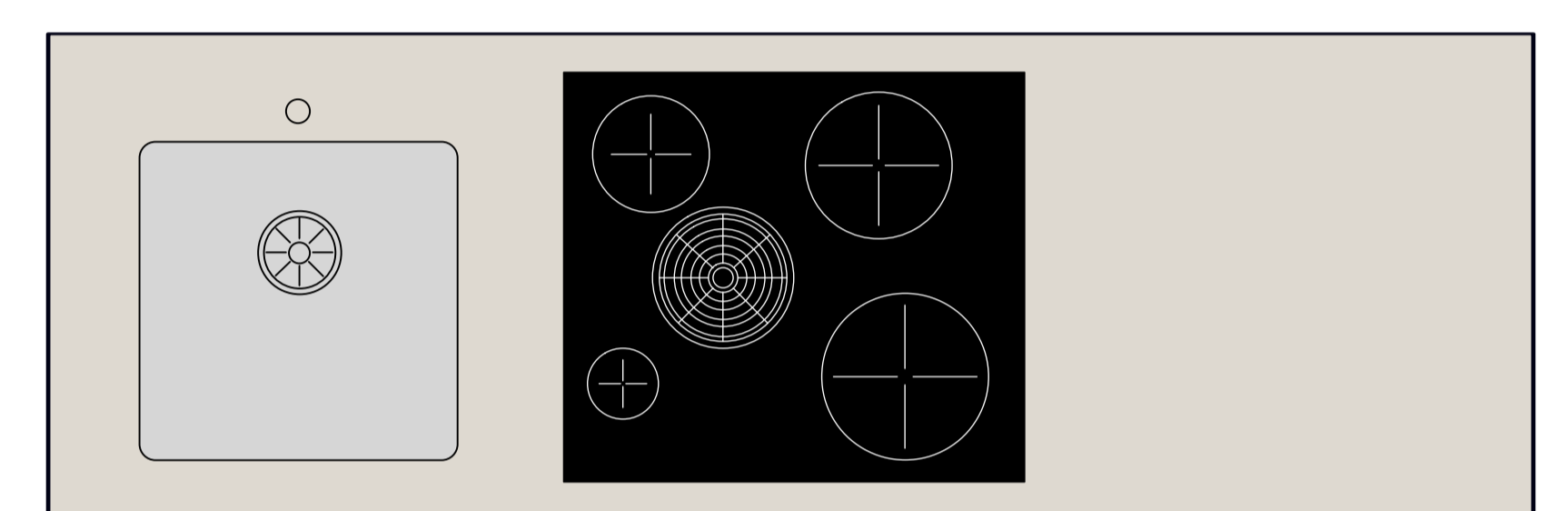

Base Unit 04

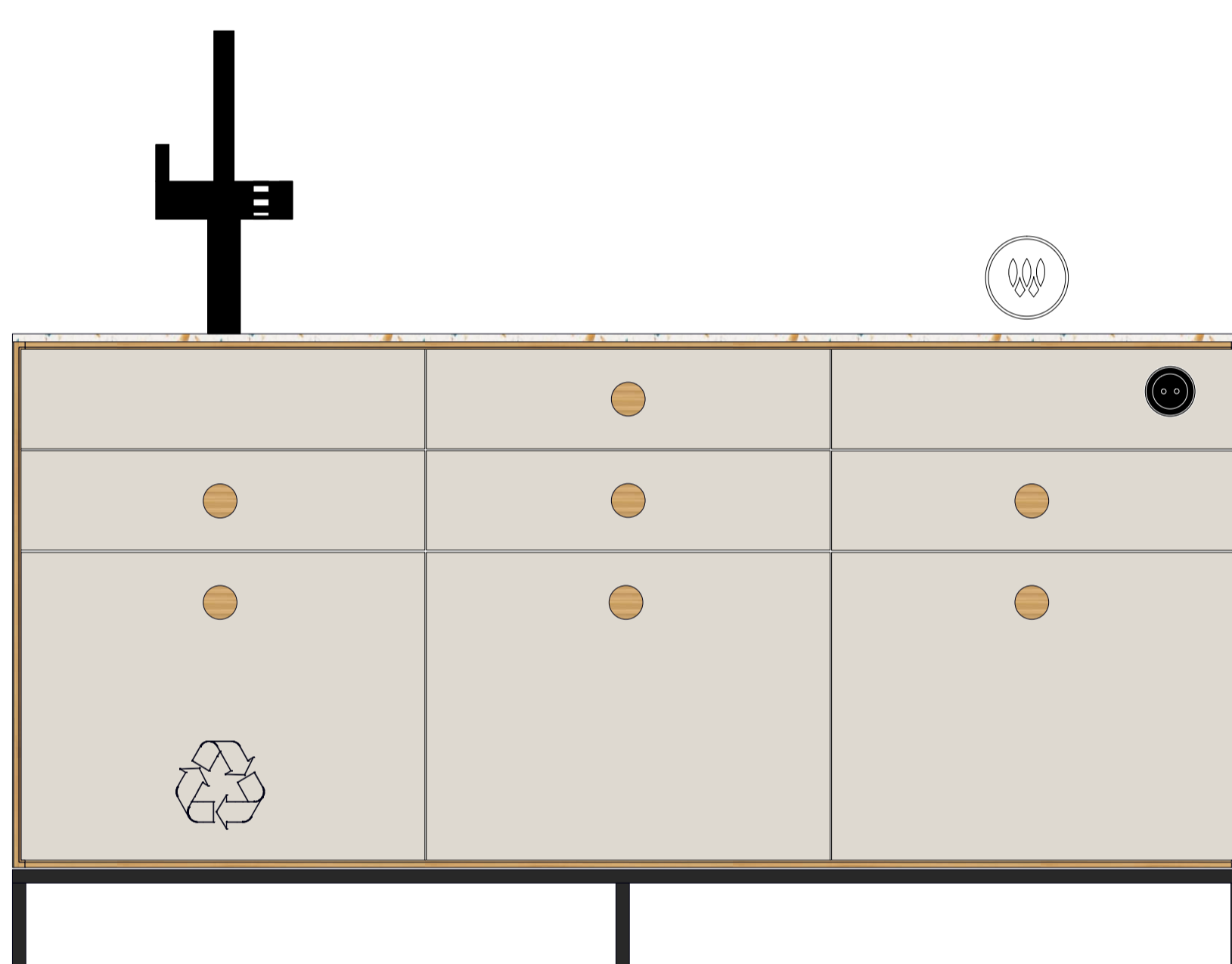
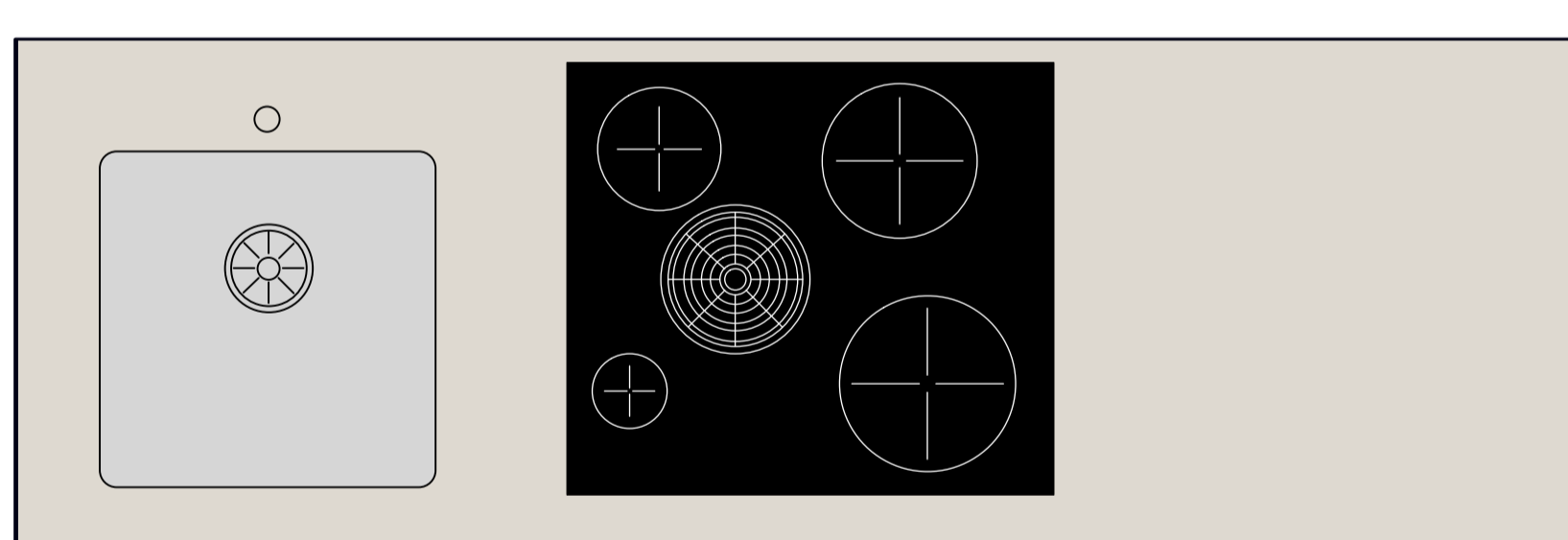

Base Unit 05

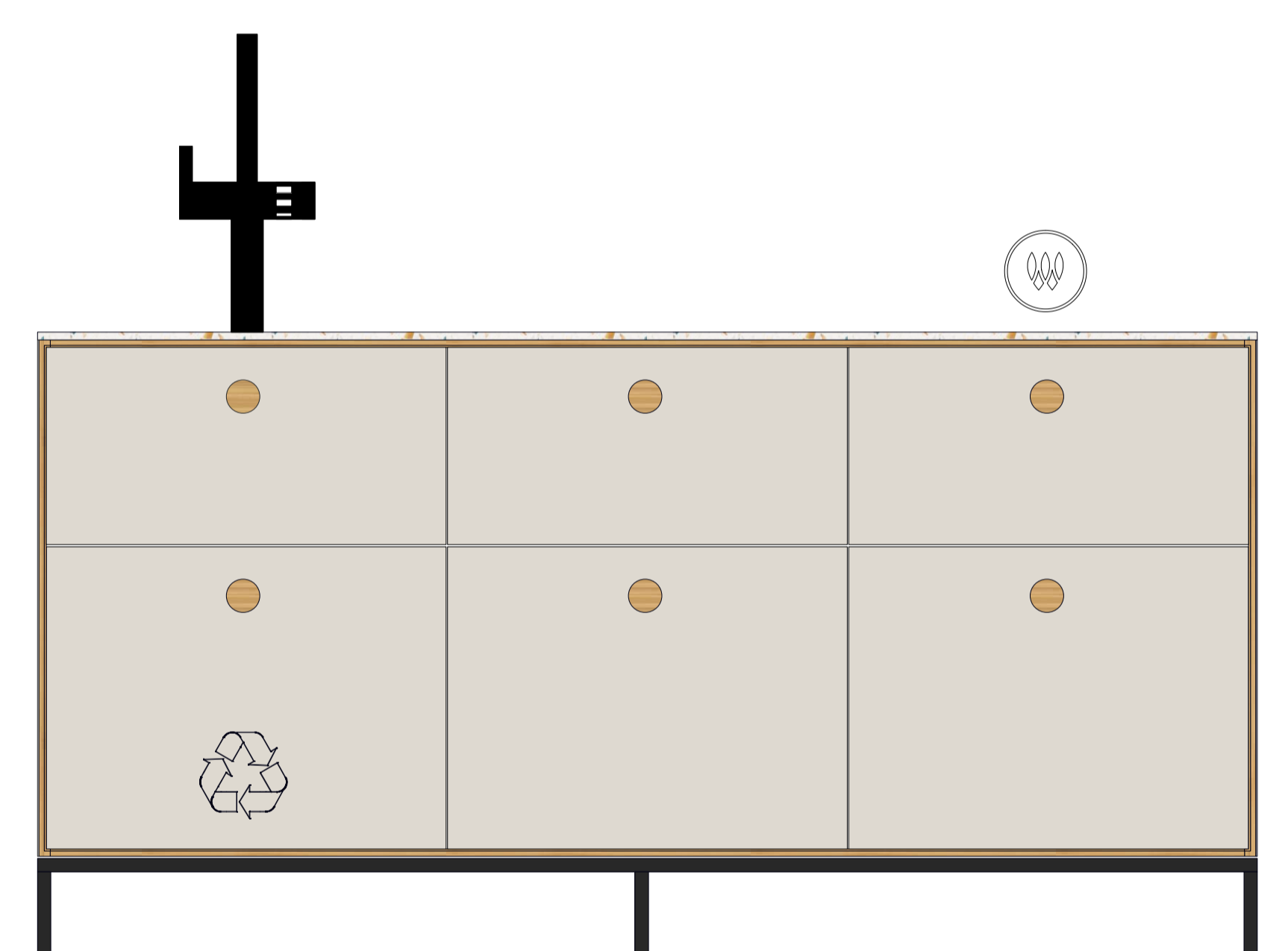

Base Unit 06

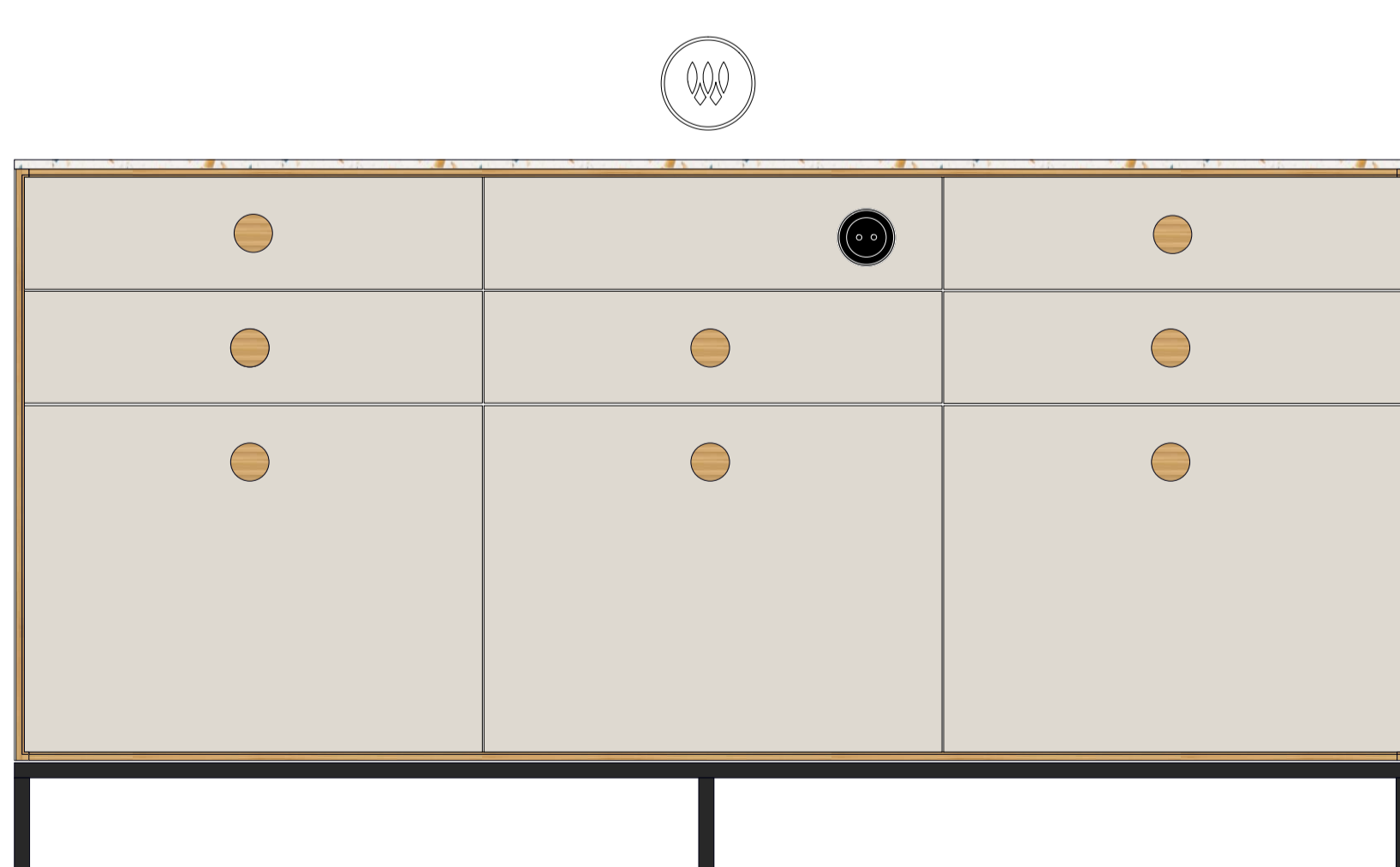

Base Unit 014

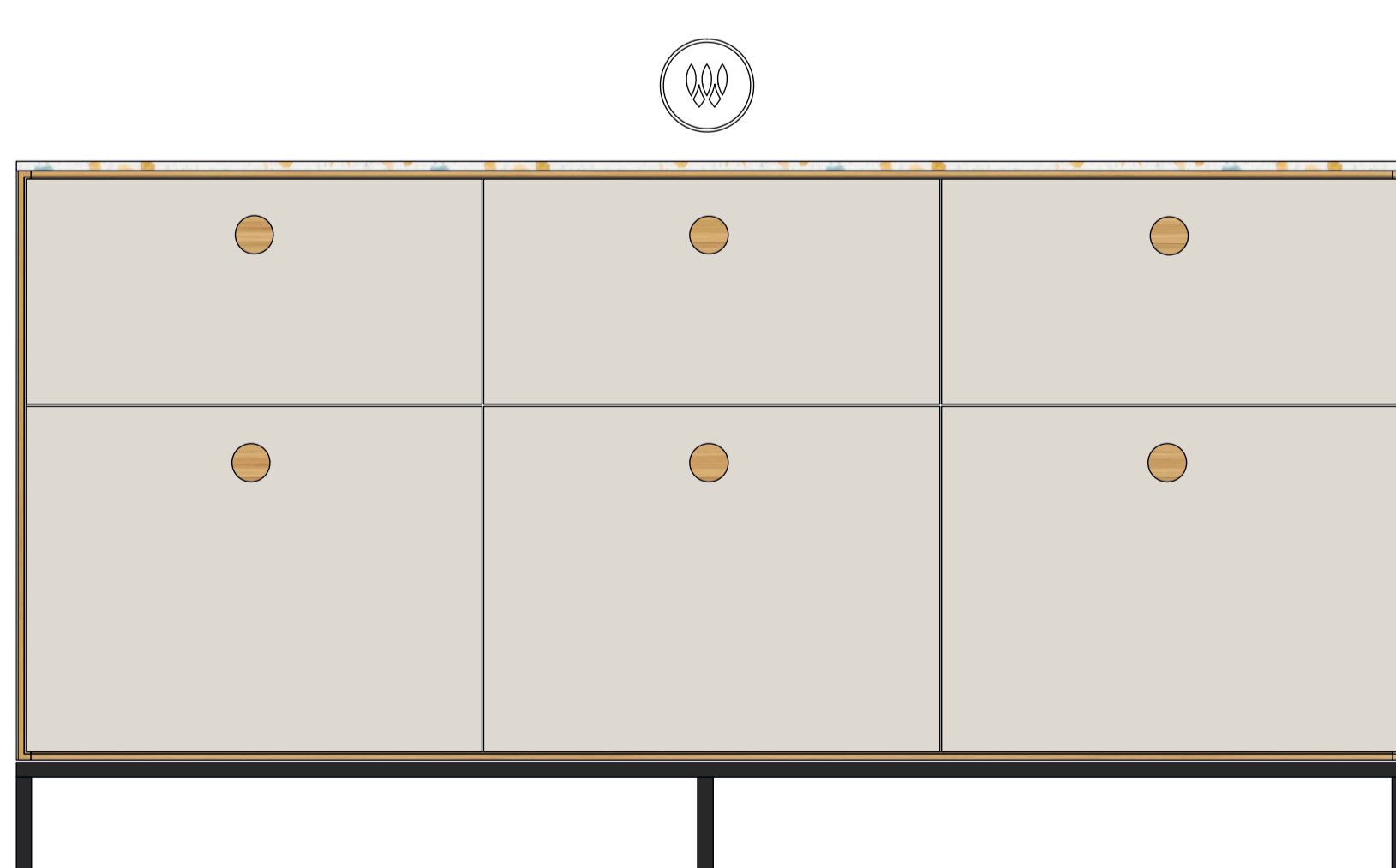
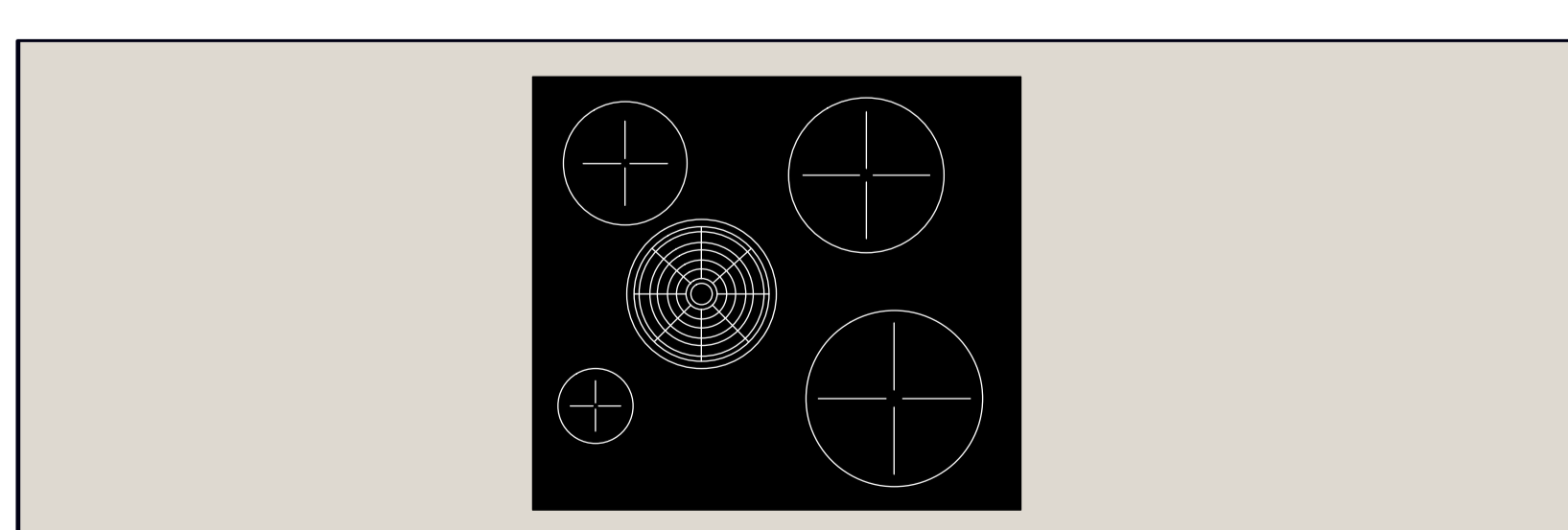

Base Unit 015

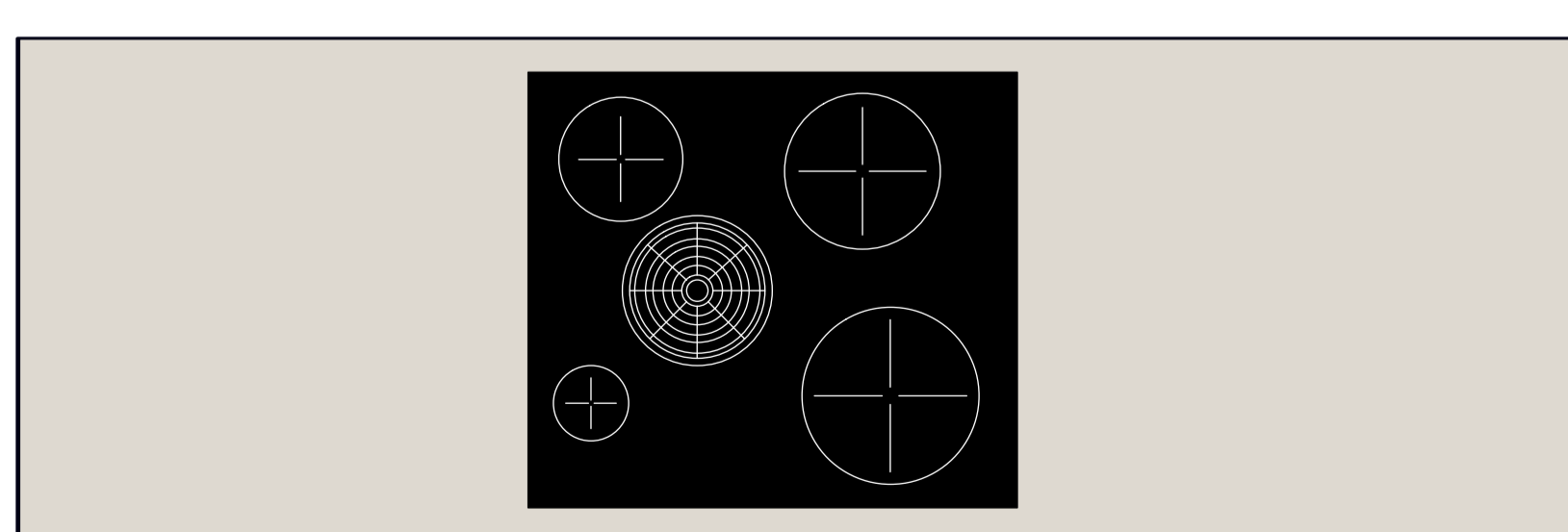

# BASE UNITS 180 cm

Legende:  Kochfeld mit Abzug,  Geschirrspüler,  Mülltrennsystem,  Kühlschrank,  Backofen,  Weinkühlchrank,

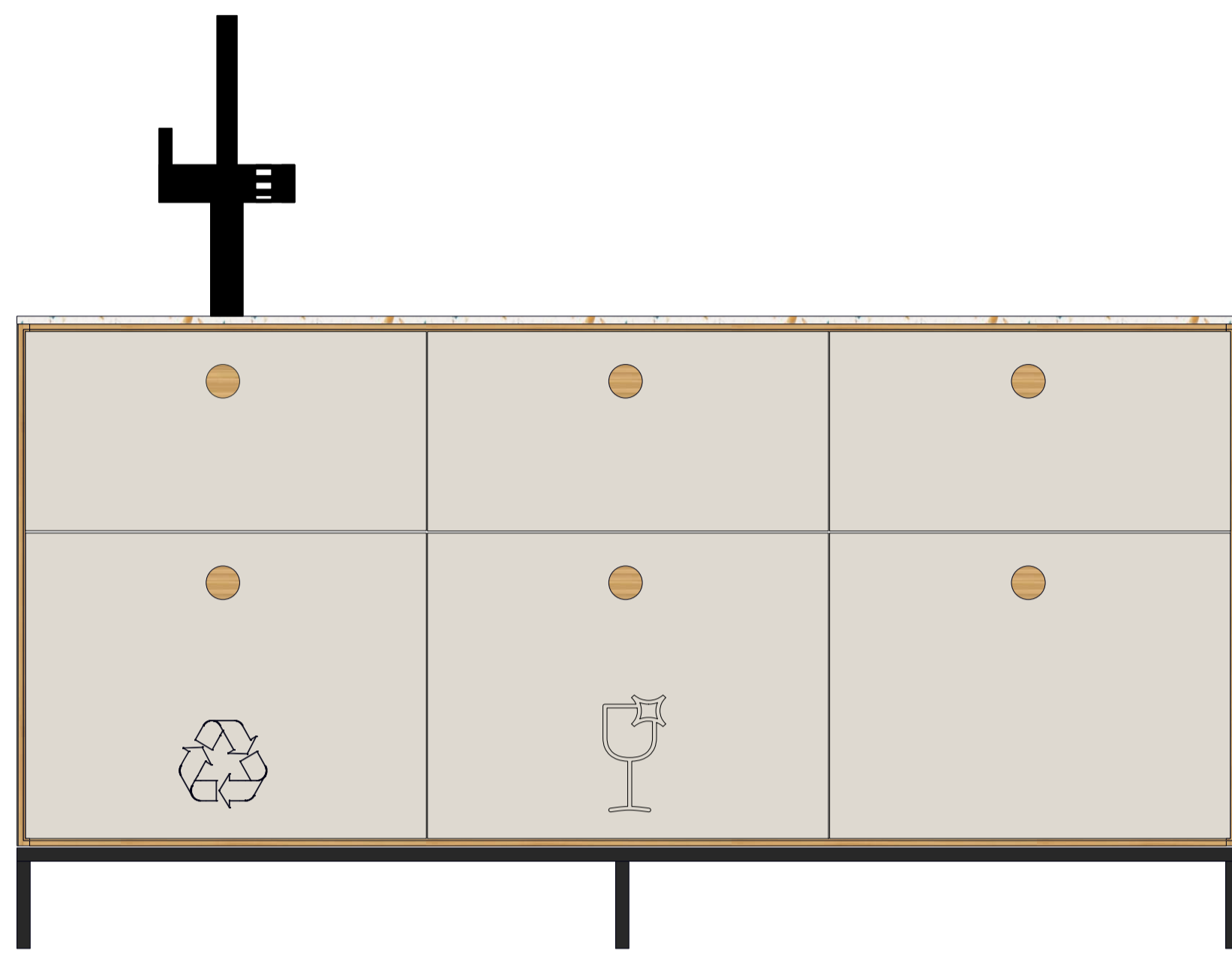

Base Unit 010

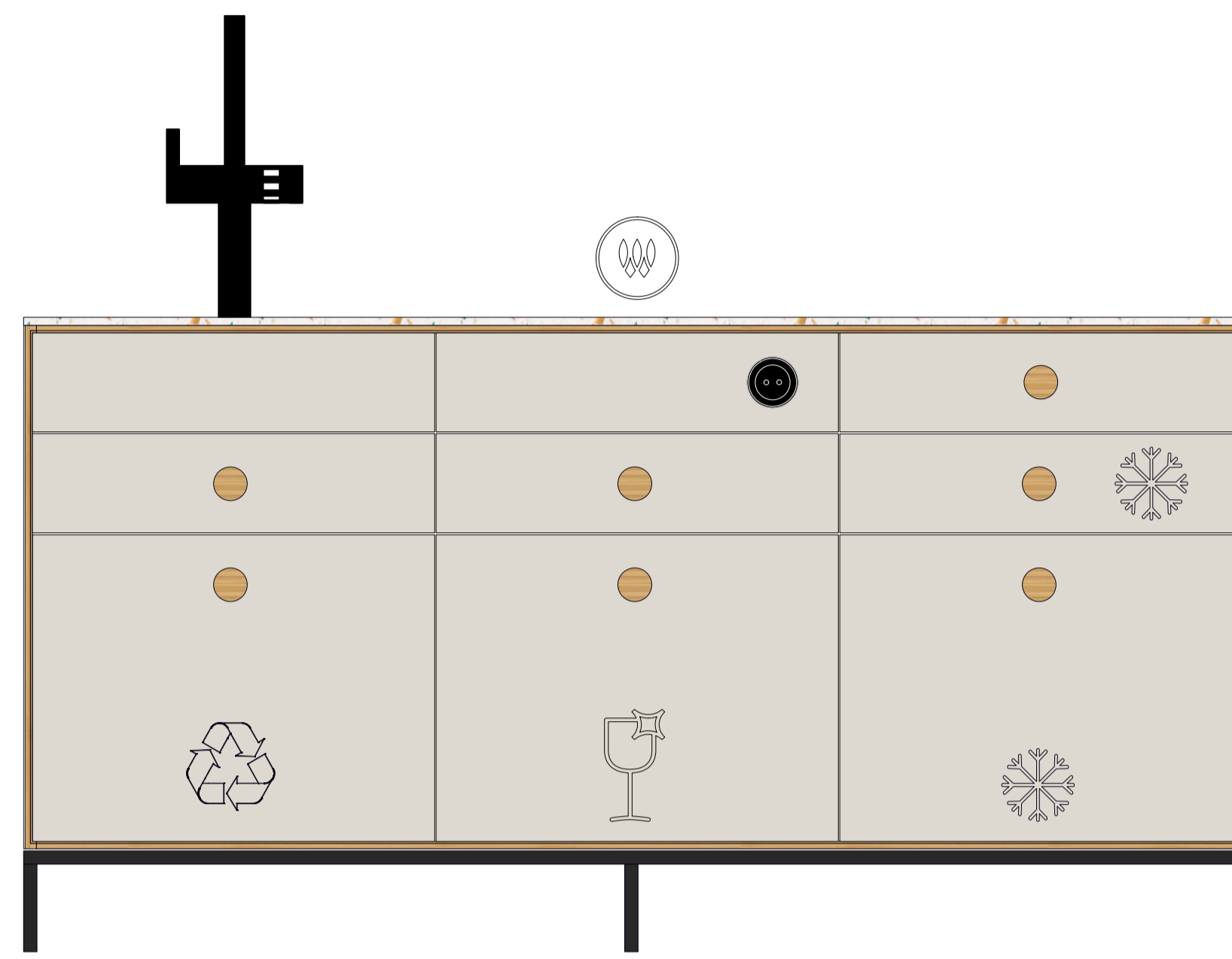
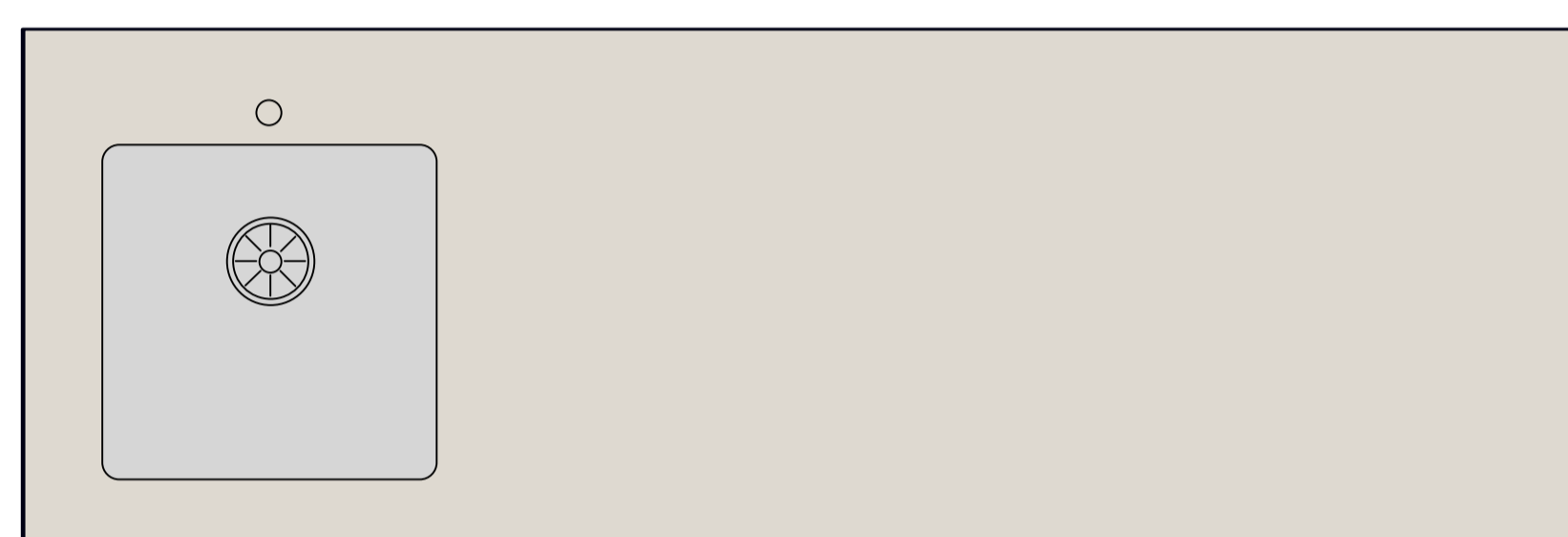

Base Unit 011

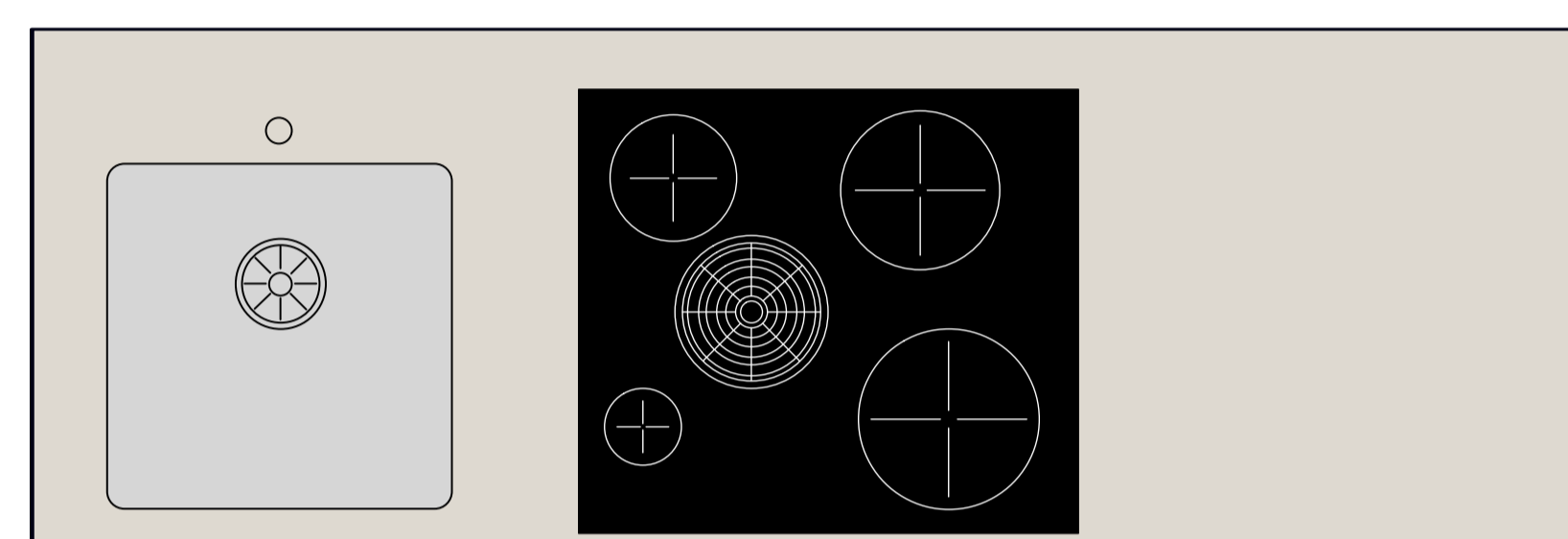

Base Unit 12

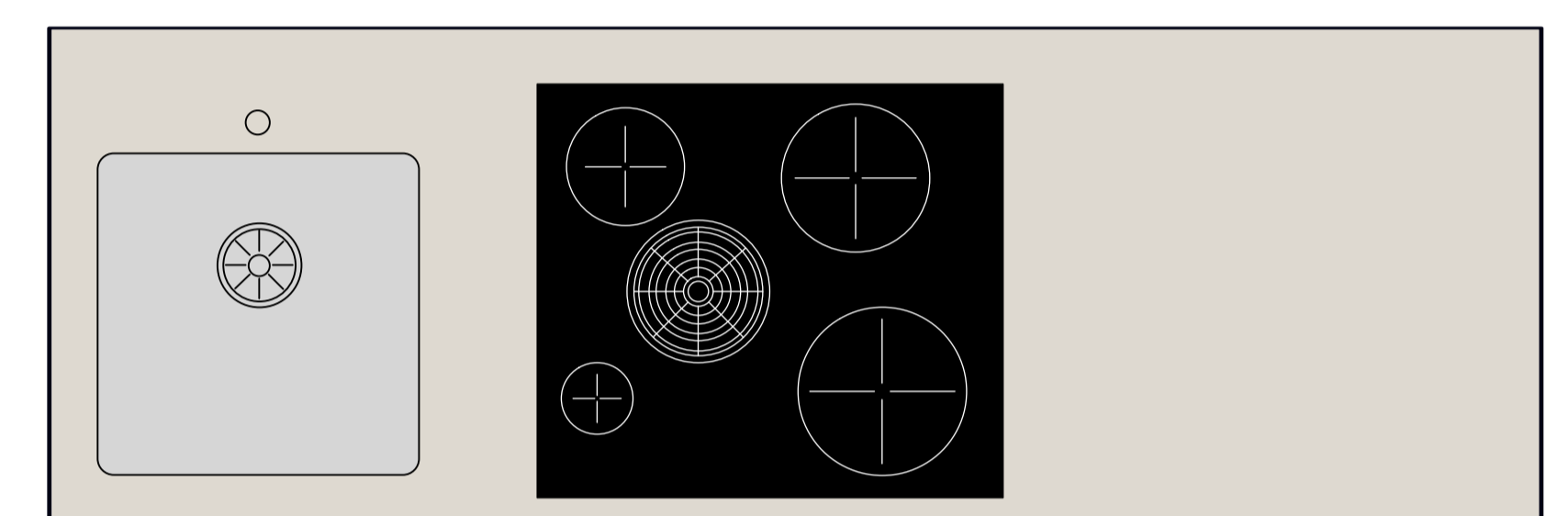

Base Unit 013

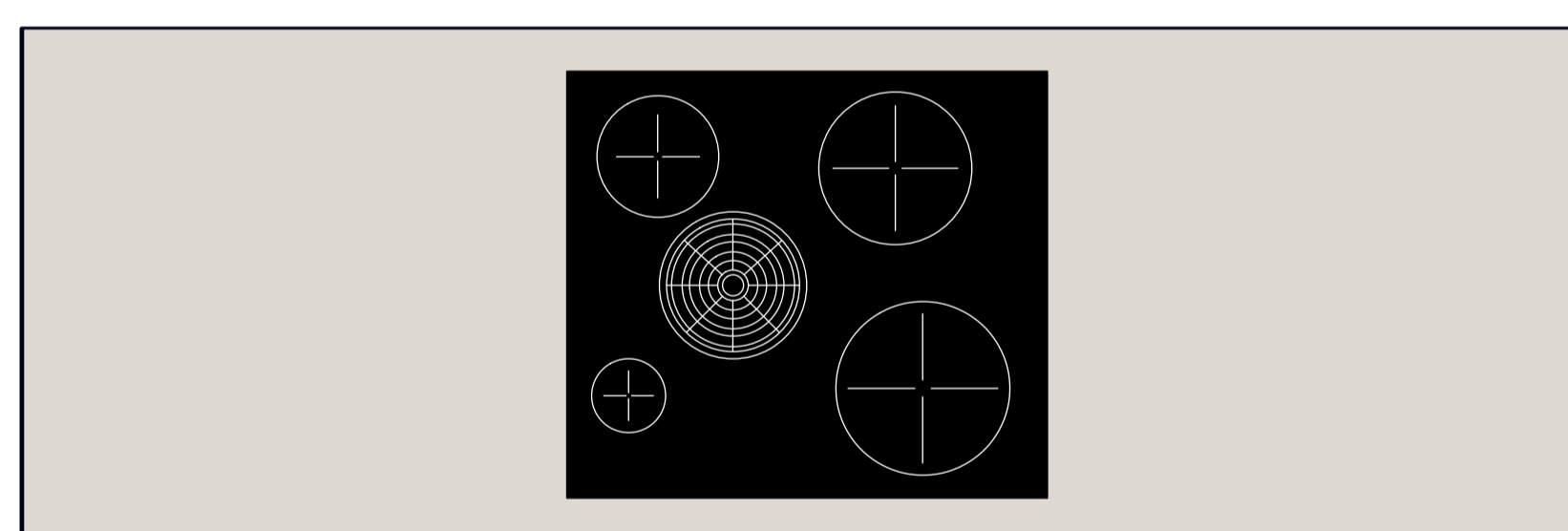

Base Unit 07

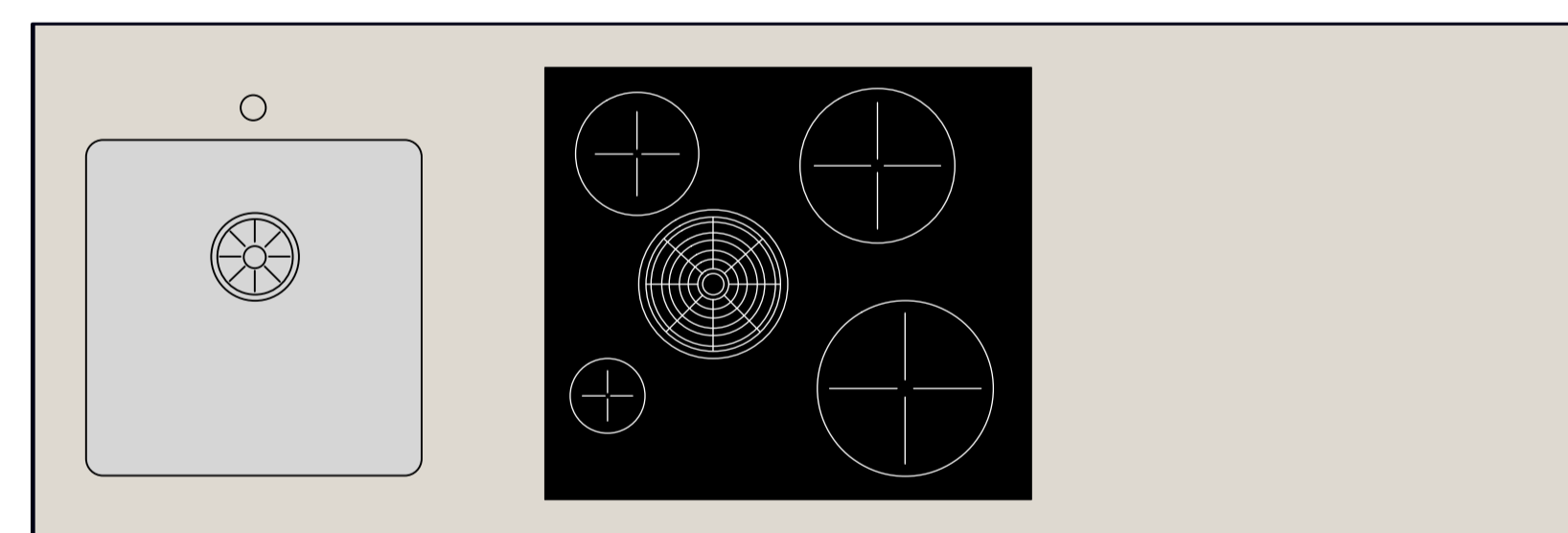

Base Unit 08

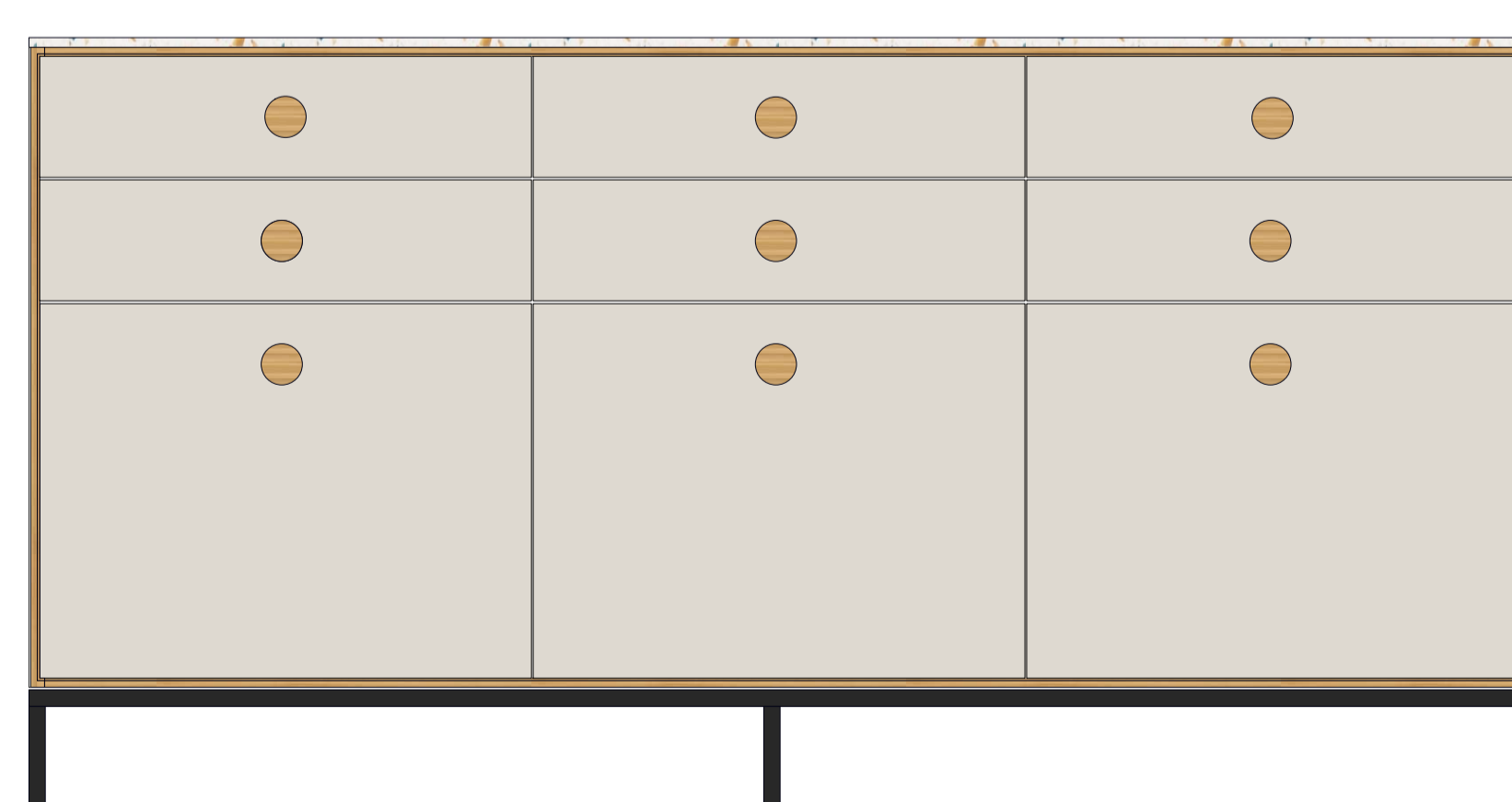
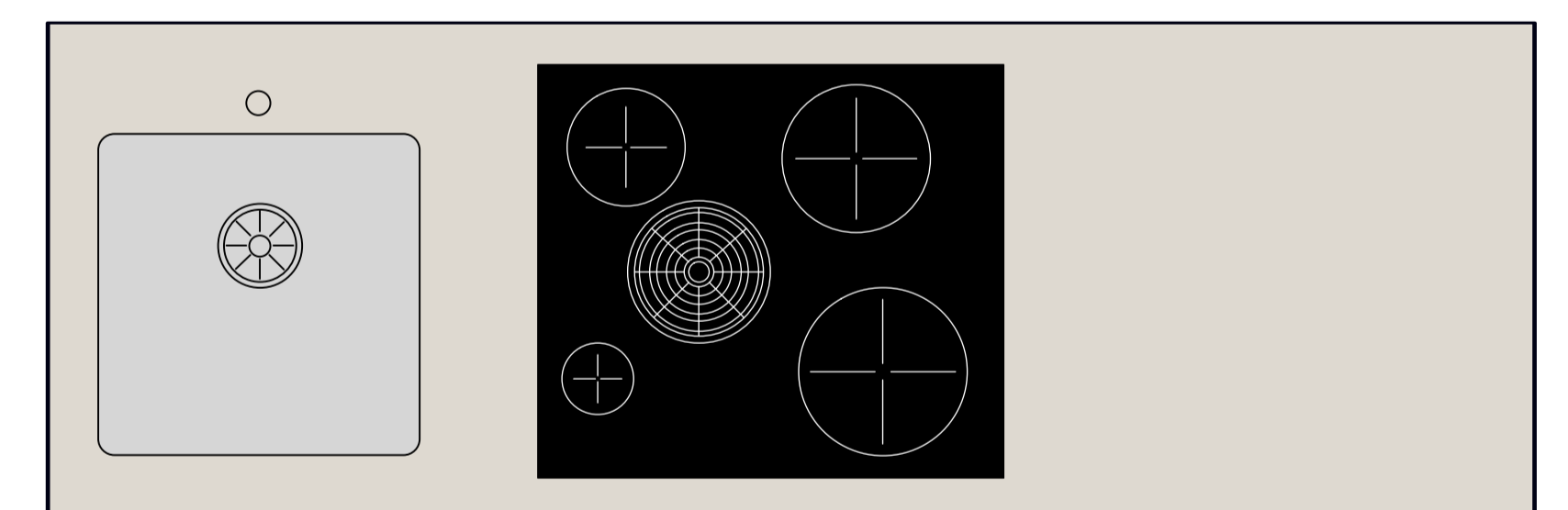

Base Unit 016

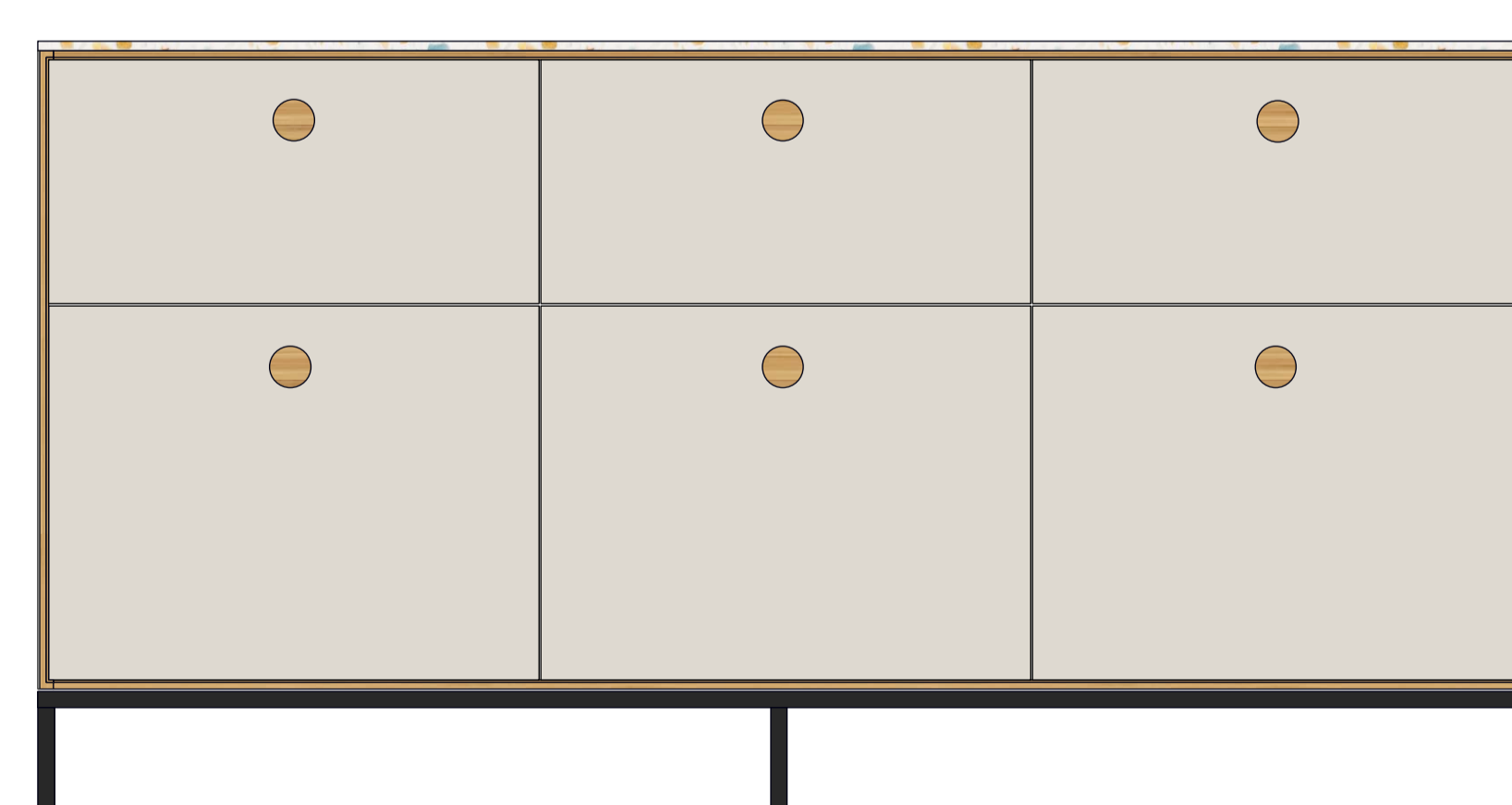

Base Unit 017

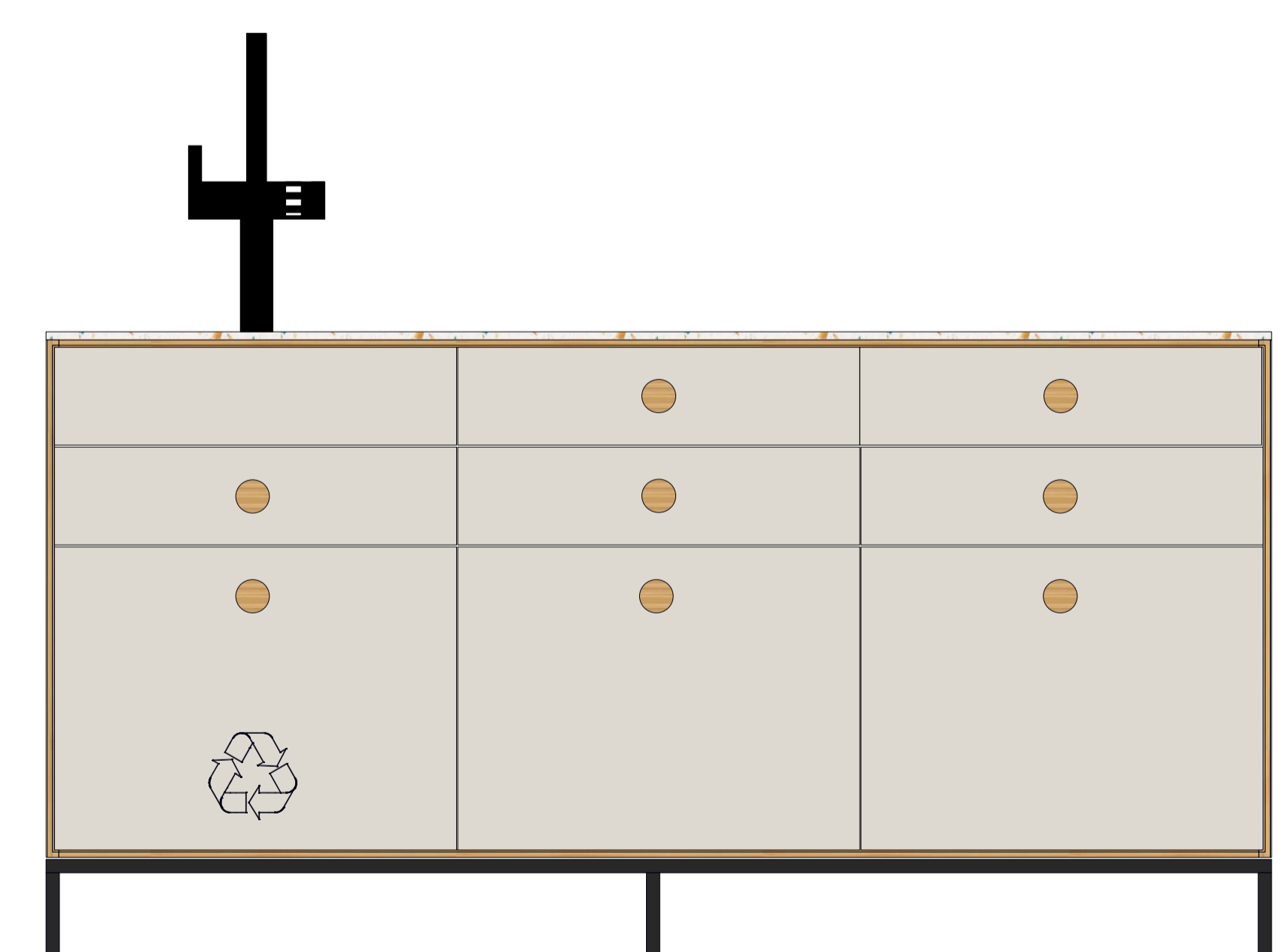

Base Unit 09

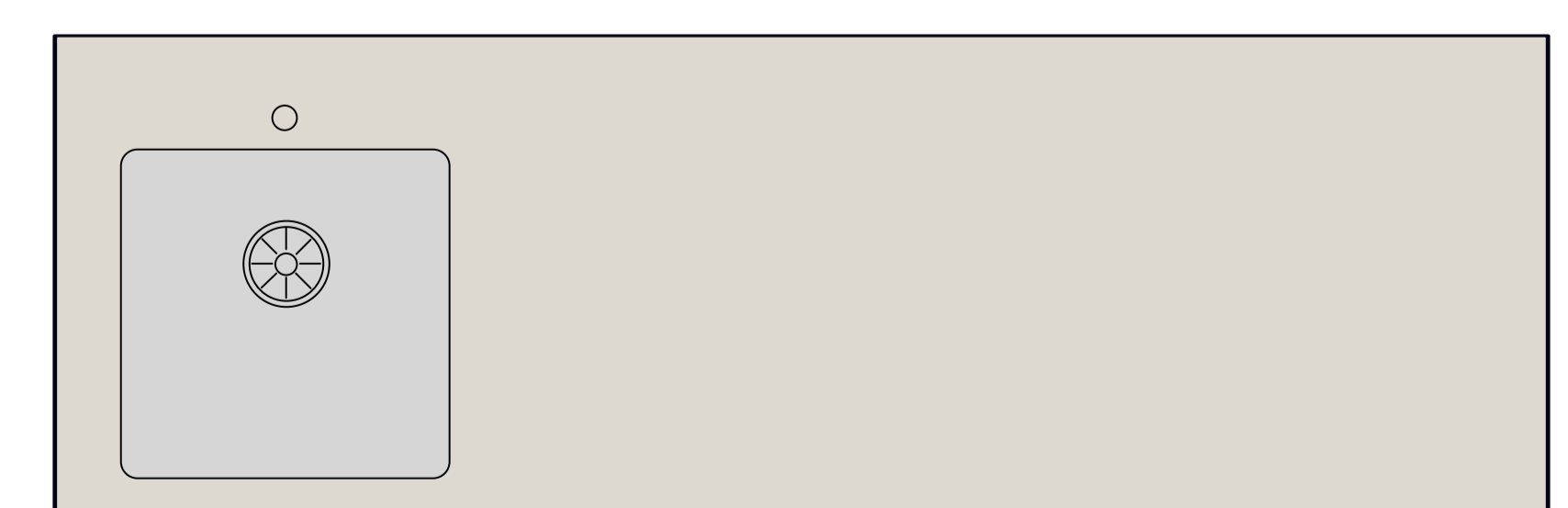

# HOCHSCHRÄNKE +++ TALL UNITS

TINY KITCHEN «OFFICE»2024 **neuvermoebelt**®

Legende:  Kochfeld mit Abzug,  Geschirrspüler,  Mülltrennsystem,  Kühlschrank,  Backofen,  Weinkühlchrank,

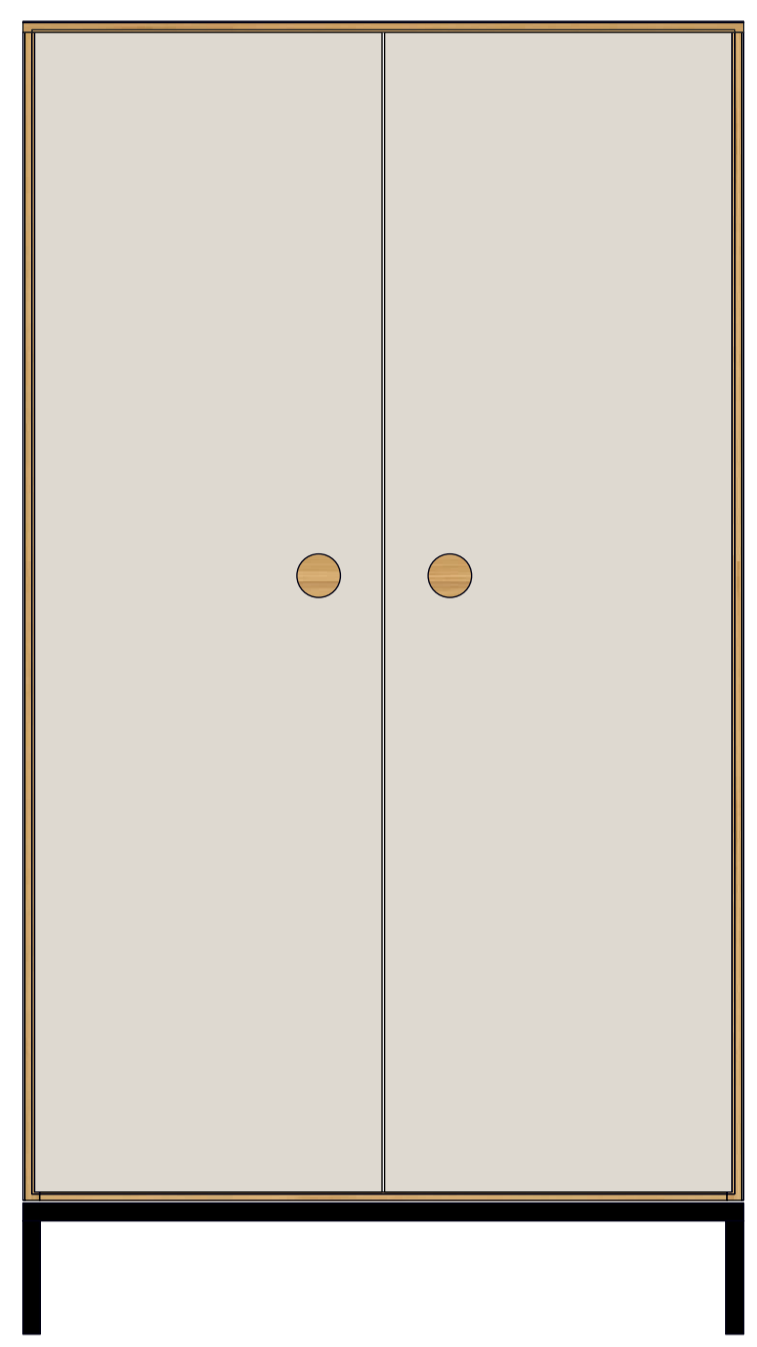

80cm

Tall Unit 001

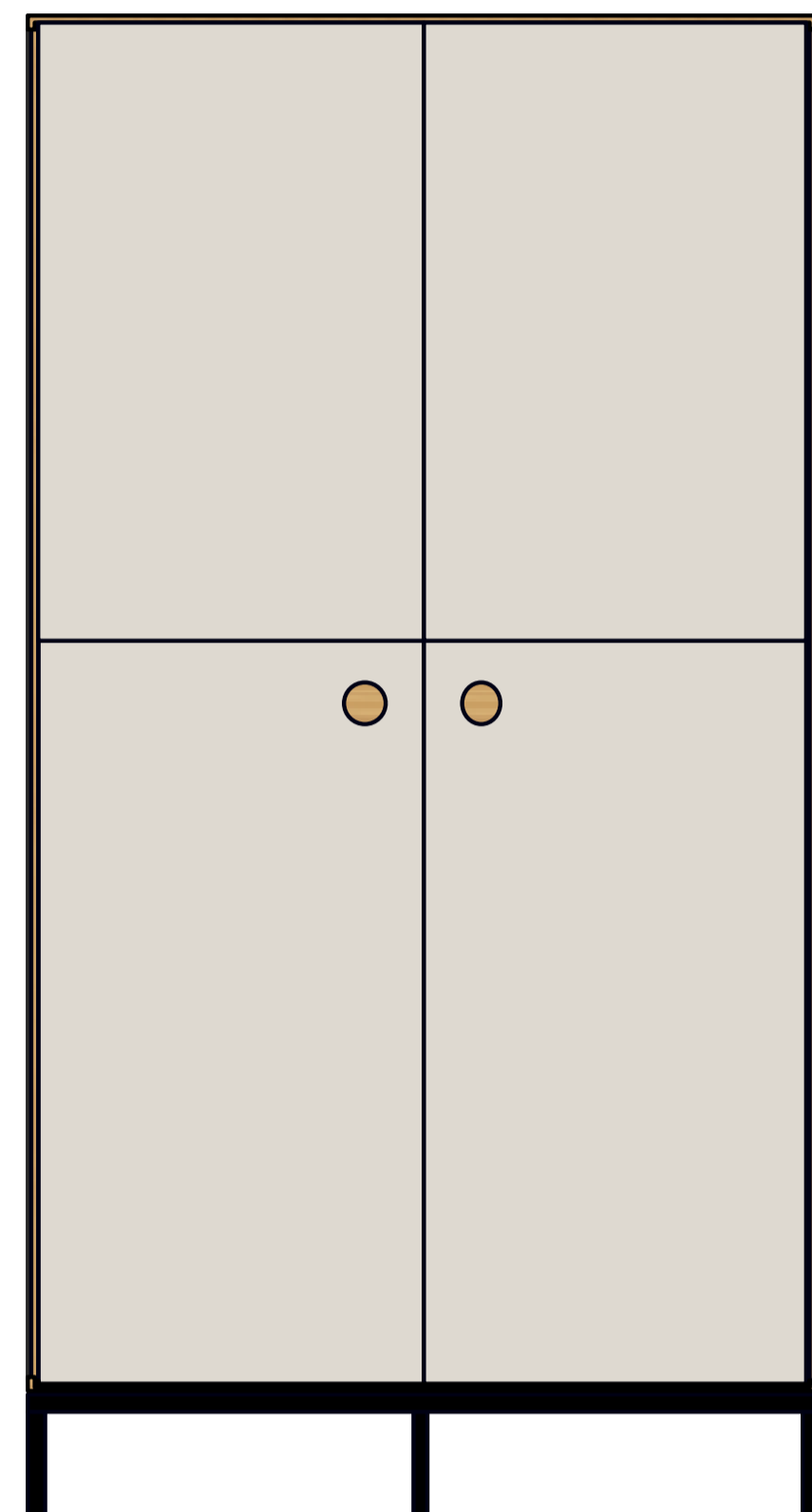

90cm

Tall Unit 002

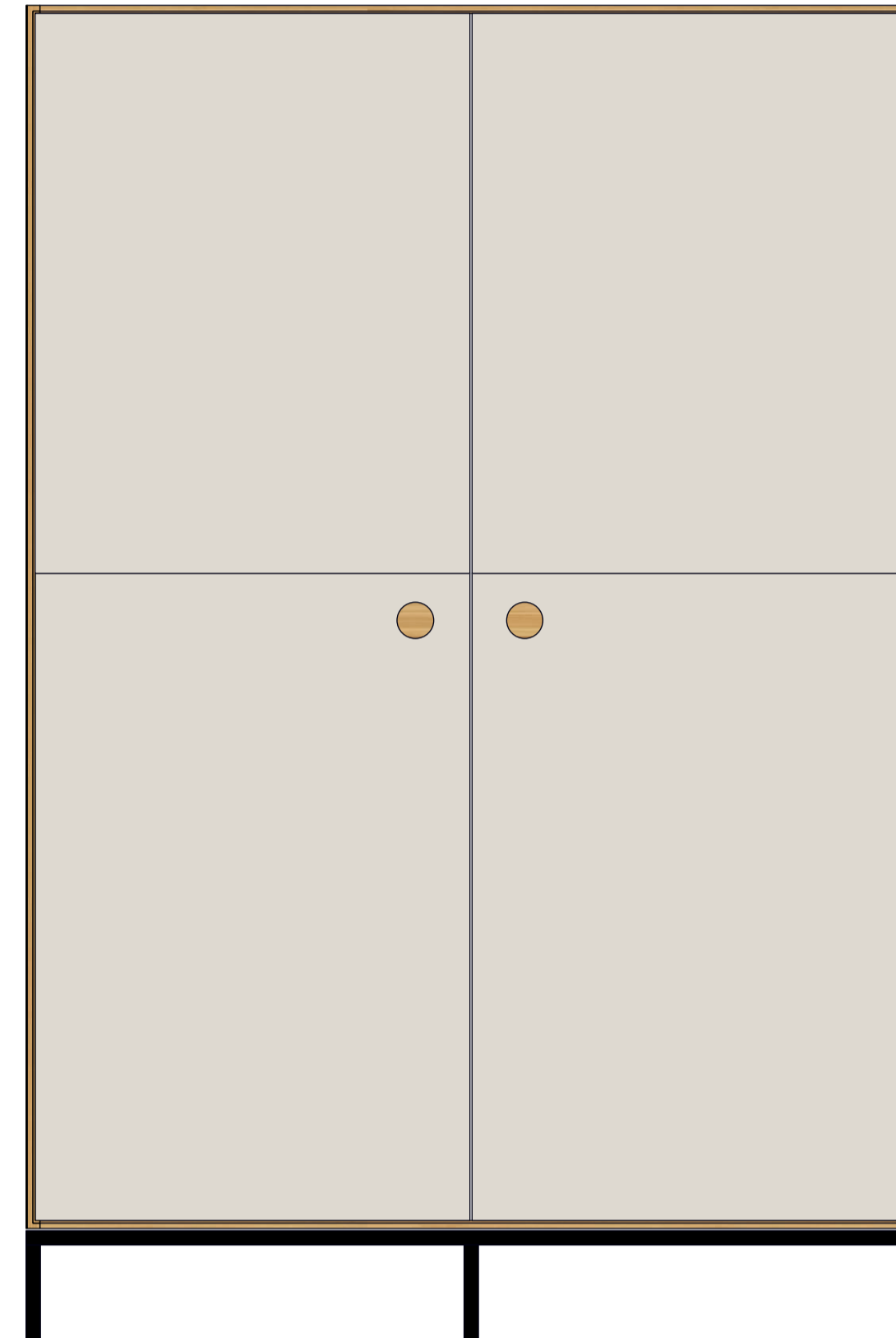

122cm

Tall Unit 003



40cm

40cm

182cm

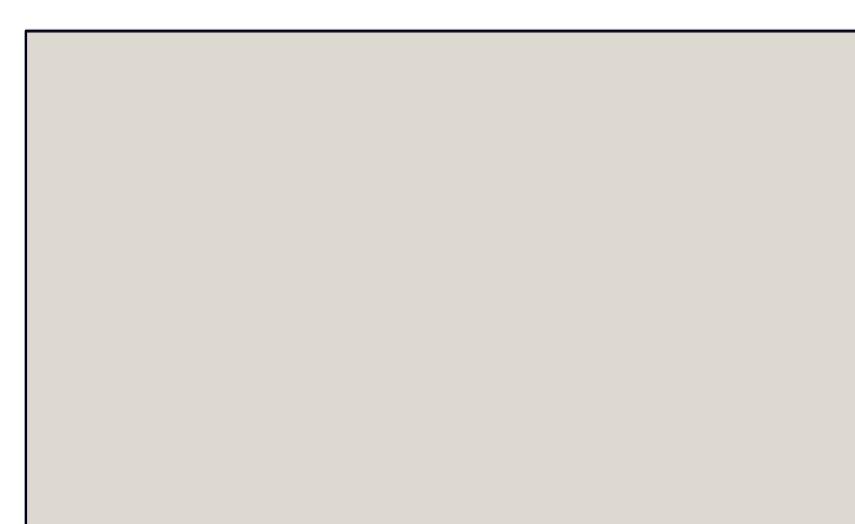
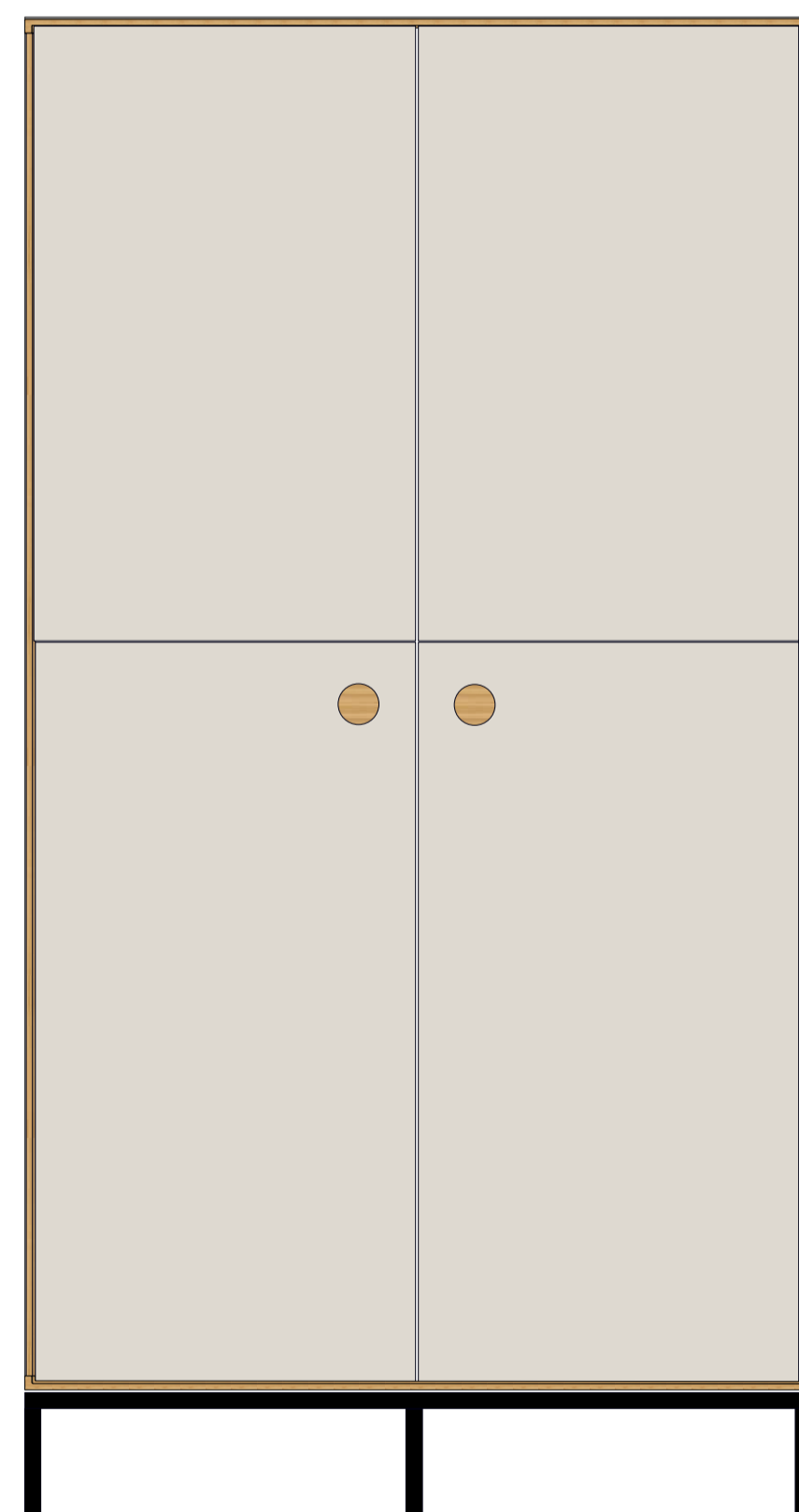

90cm

Tall Unit 004

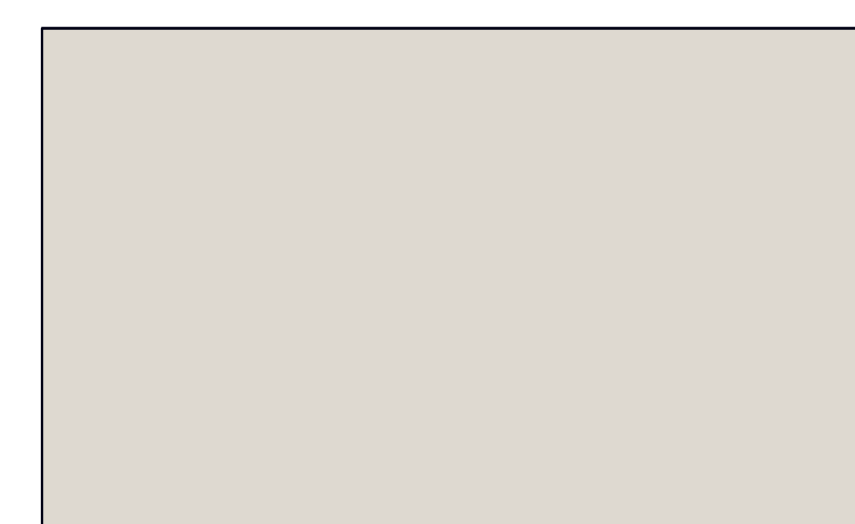
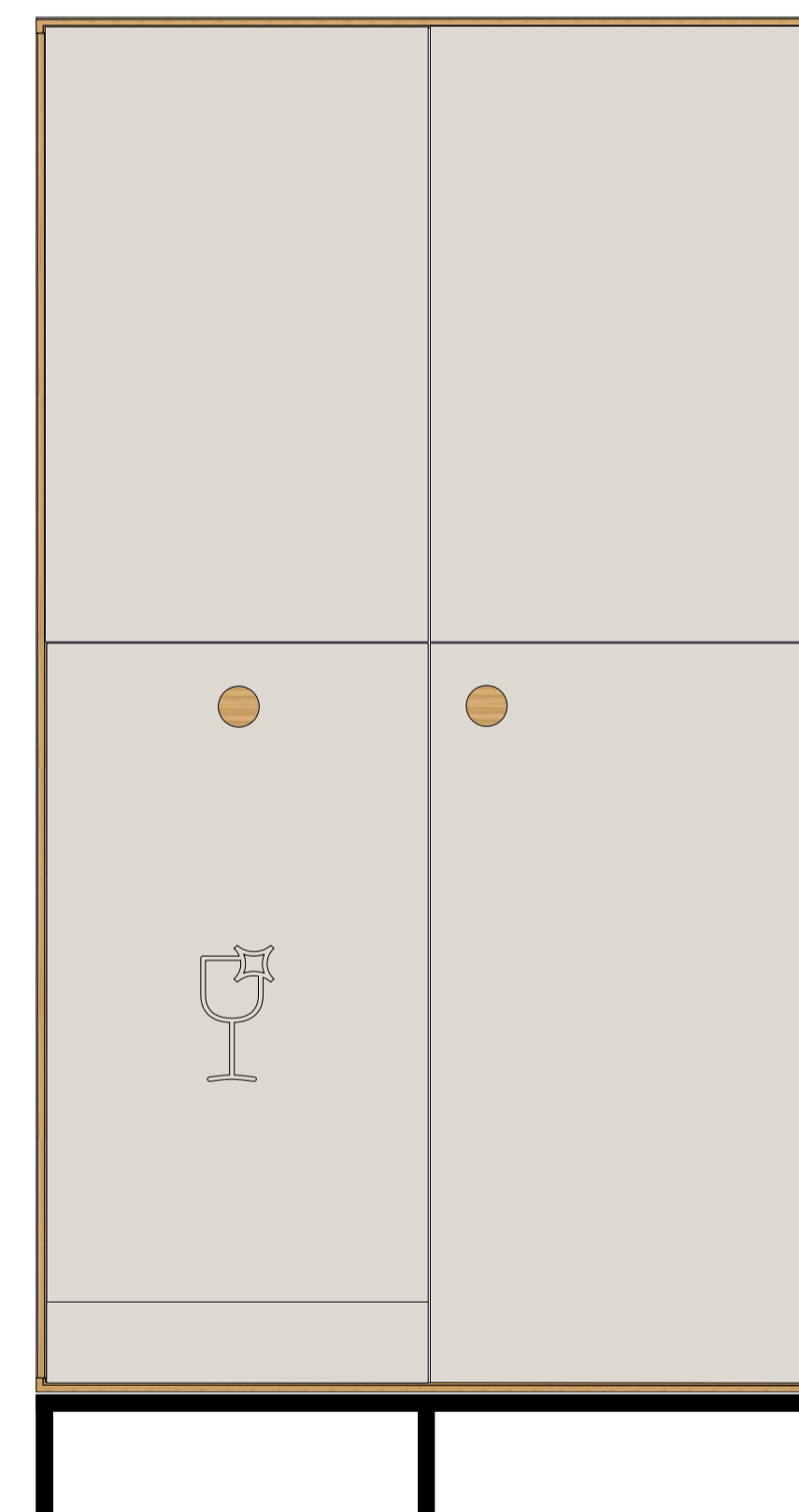

90cm

Tall Unit 005

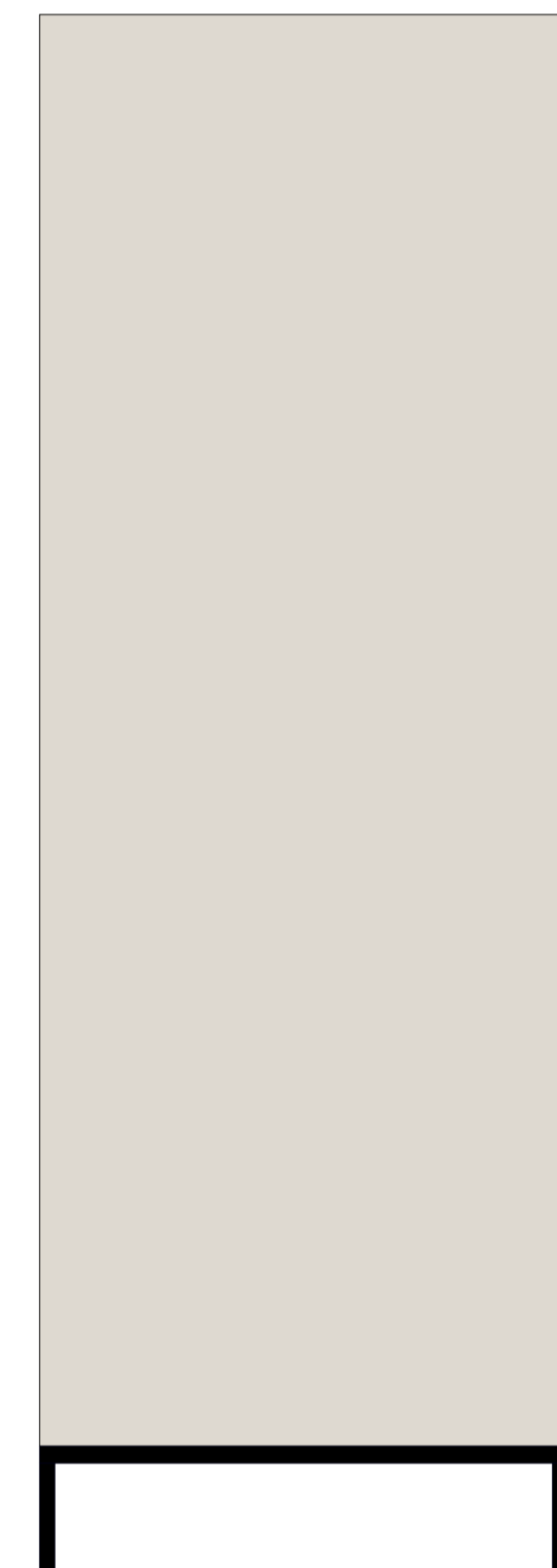

62cm

62cm

182cm

# HOCHSCHRÄNKE +++ TALL UNITS

TINY KITCHEN «OFFICE»2024 **neuvermoebelt**®

Legende:  Kochfeld mit Abzug,  Geschirrspüler,  Mülltrennsystem,  Kühlschrank,  Backofen,  Weinkühlchrank,

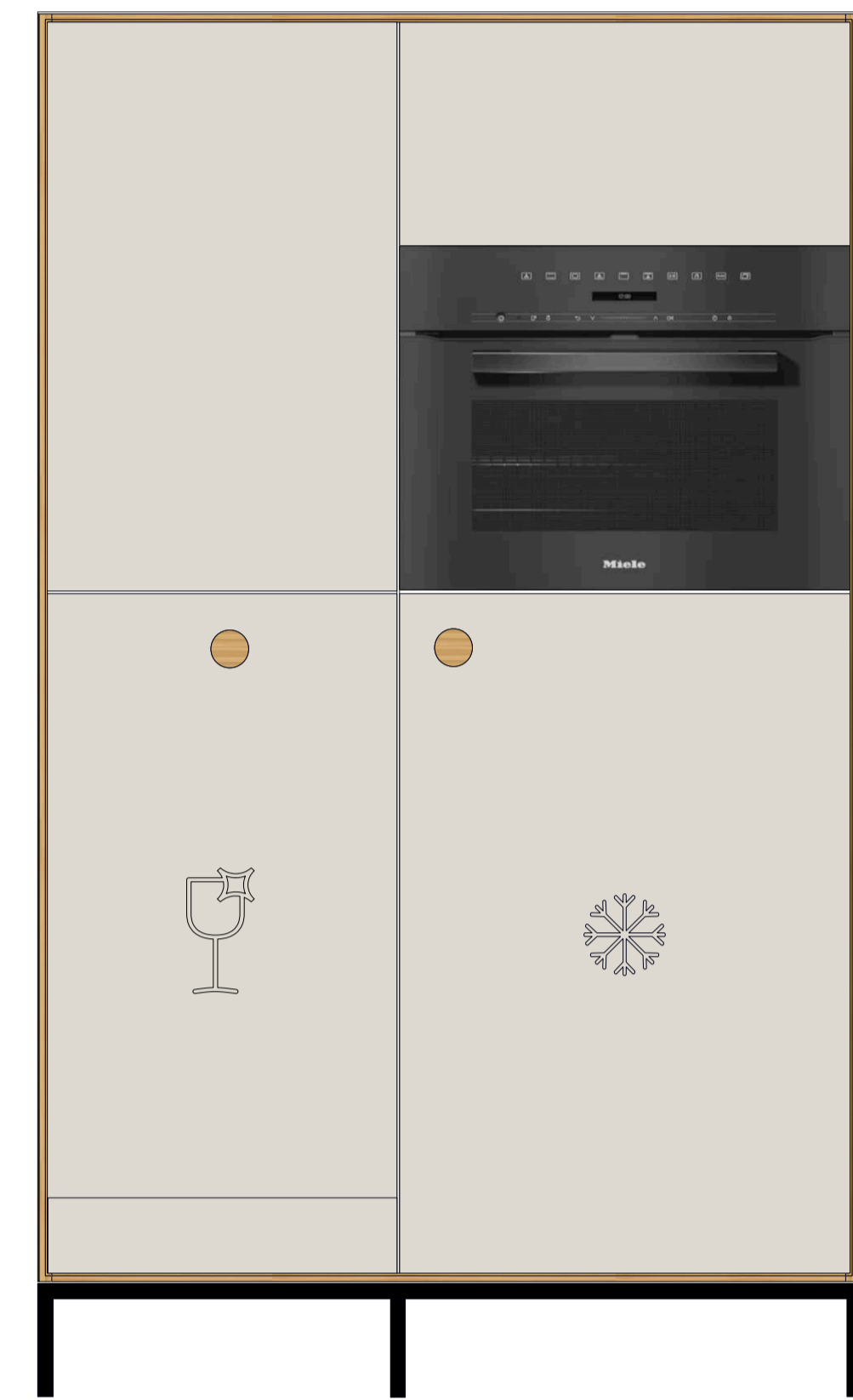

105cm

Tall Unit 006

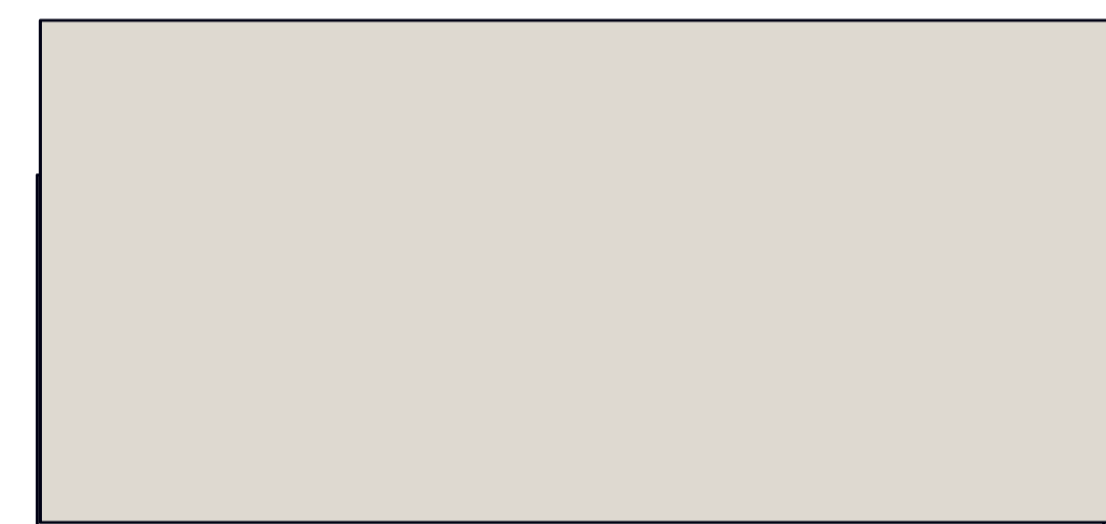
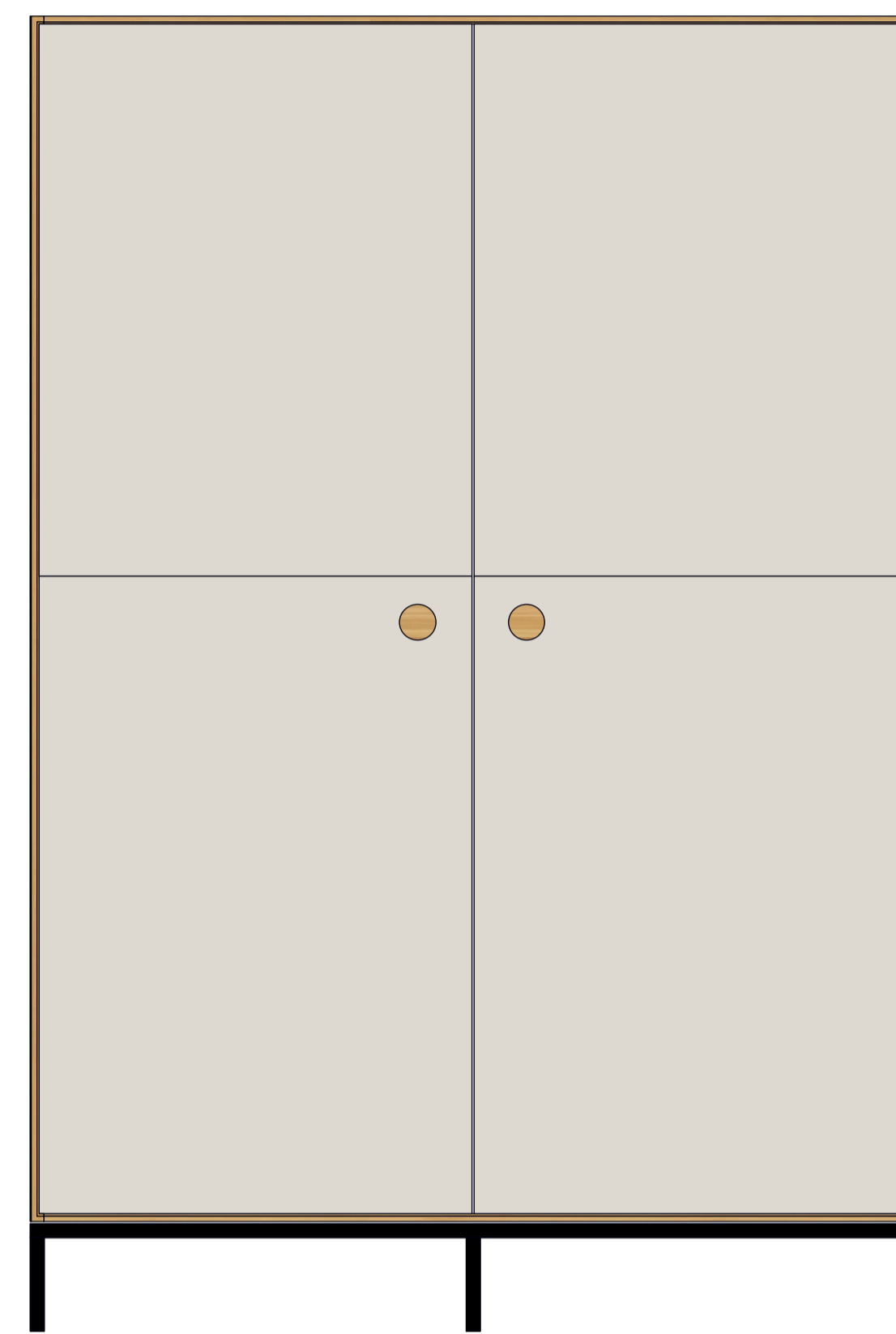

122cm

Tall Unit 007

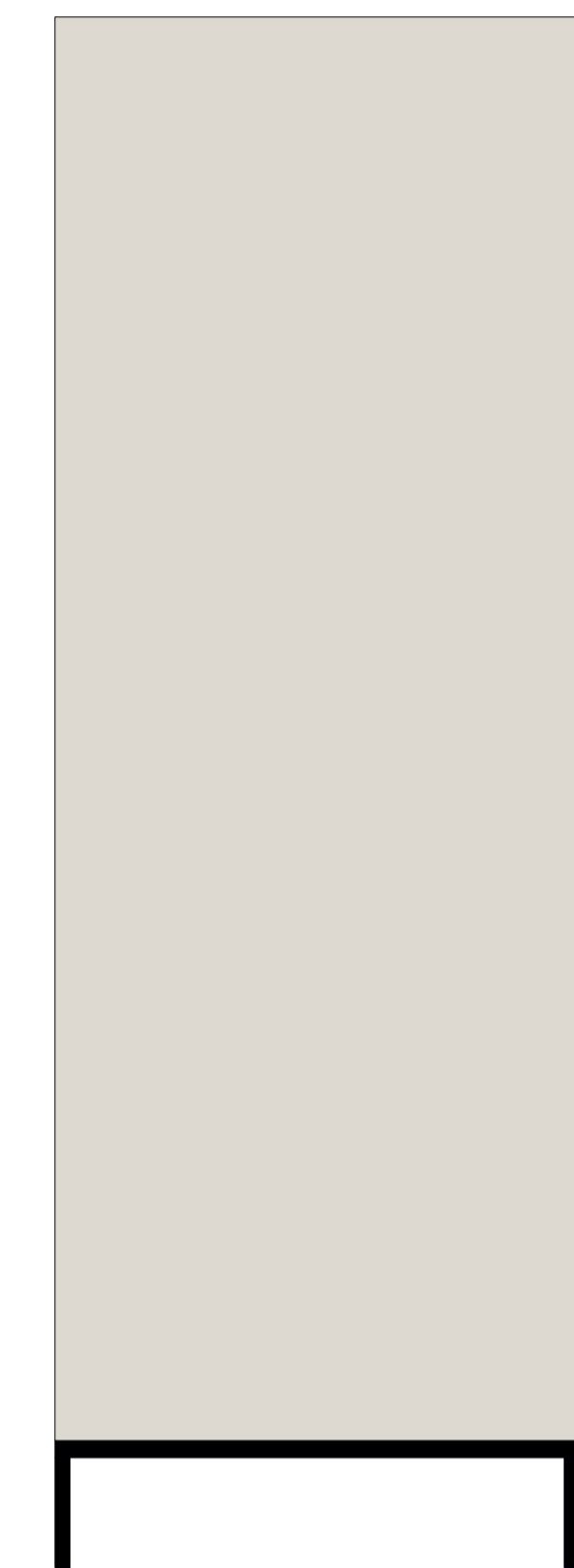

92cm

62cm

60cm



122cm

Tall Unit 008



122cm

Tall Unit 009

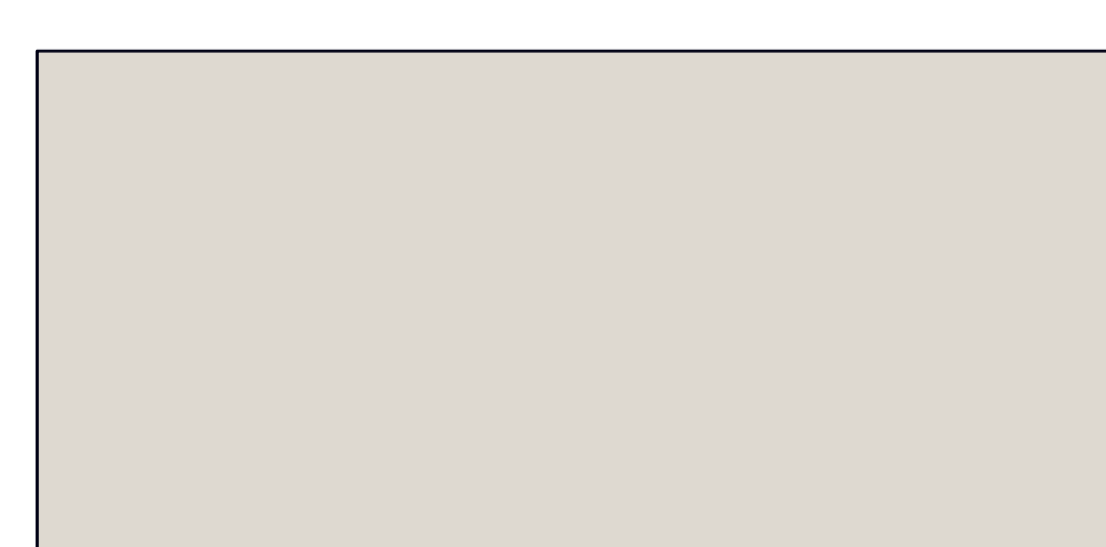
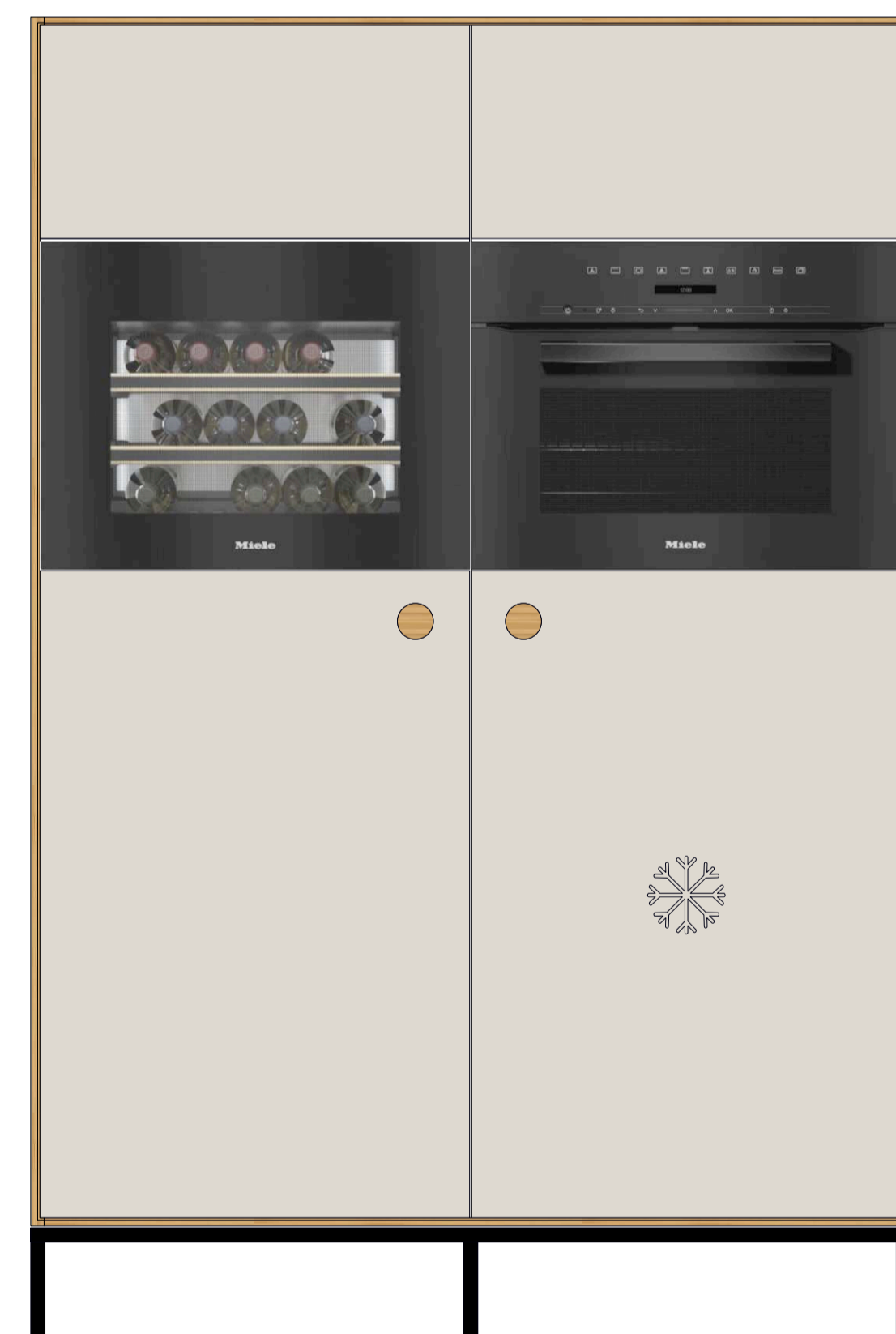

122cm

Tall Unit 010

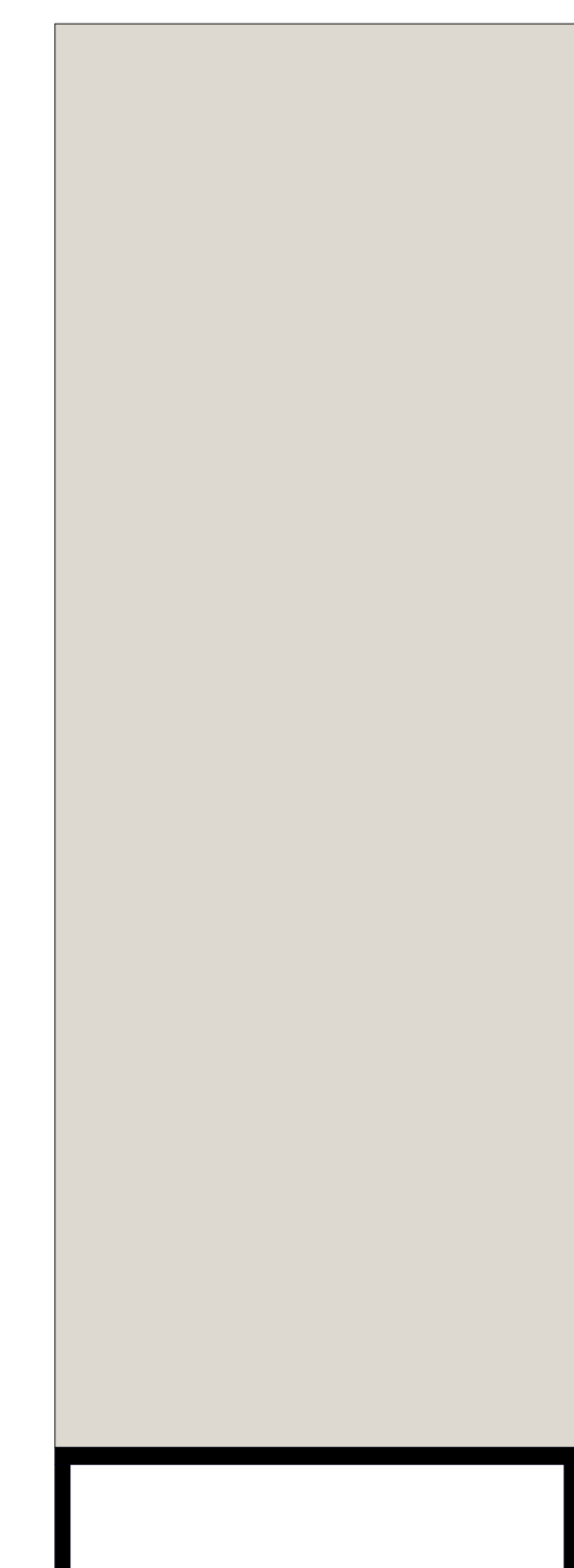

92cm

62cm

60cm

# UNIT KOMBINATIONEN +++ UNIT COMBINATIONS

Legende:  Kochfeld mit Abzug,  Geschirrspüler,  Mülltrennsystem,  Kühlschrank,  Backofen,  Weinkühlchrank,



Base Unit 010

Base Unit 028

Tall Unit 003

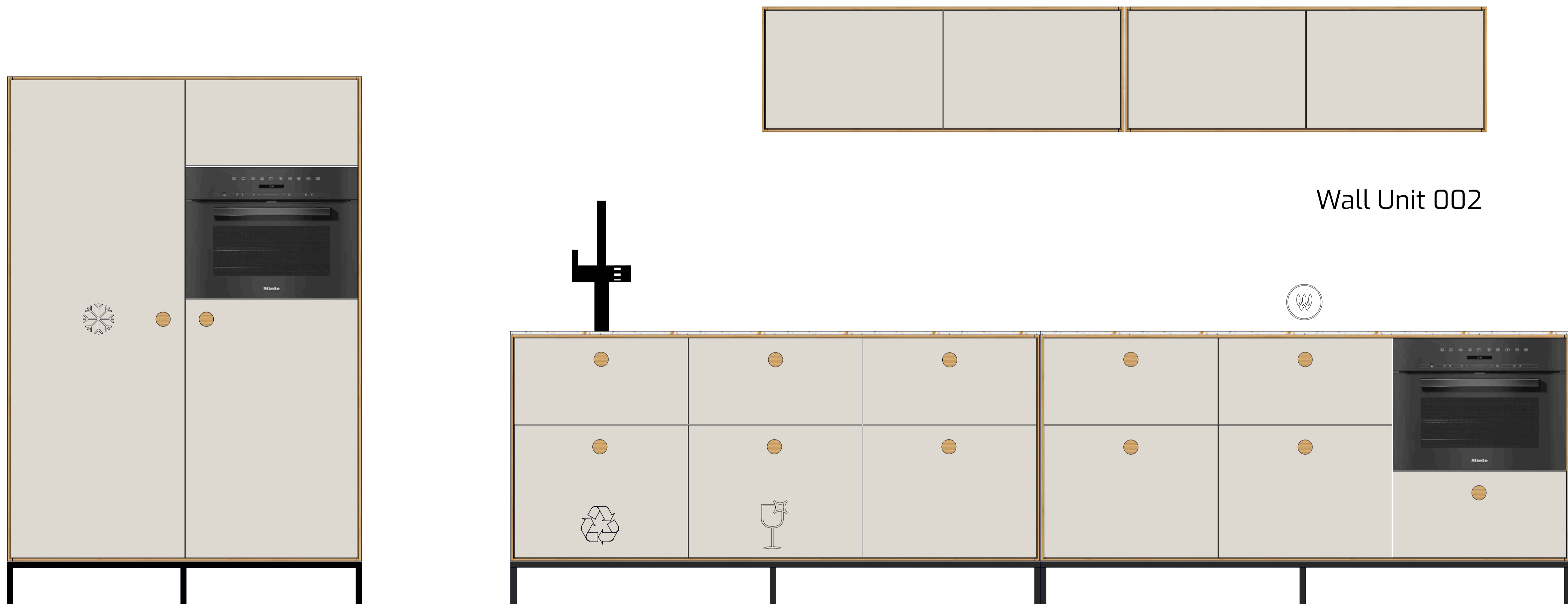

Tall Unit 008

Base Unit 010

Base Unit 013

Wall Unit 002

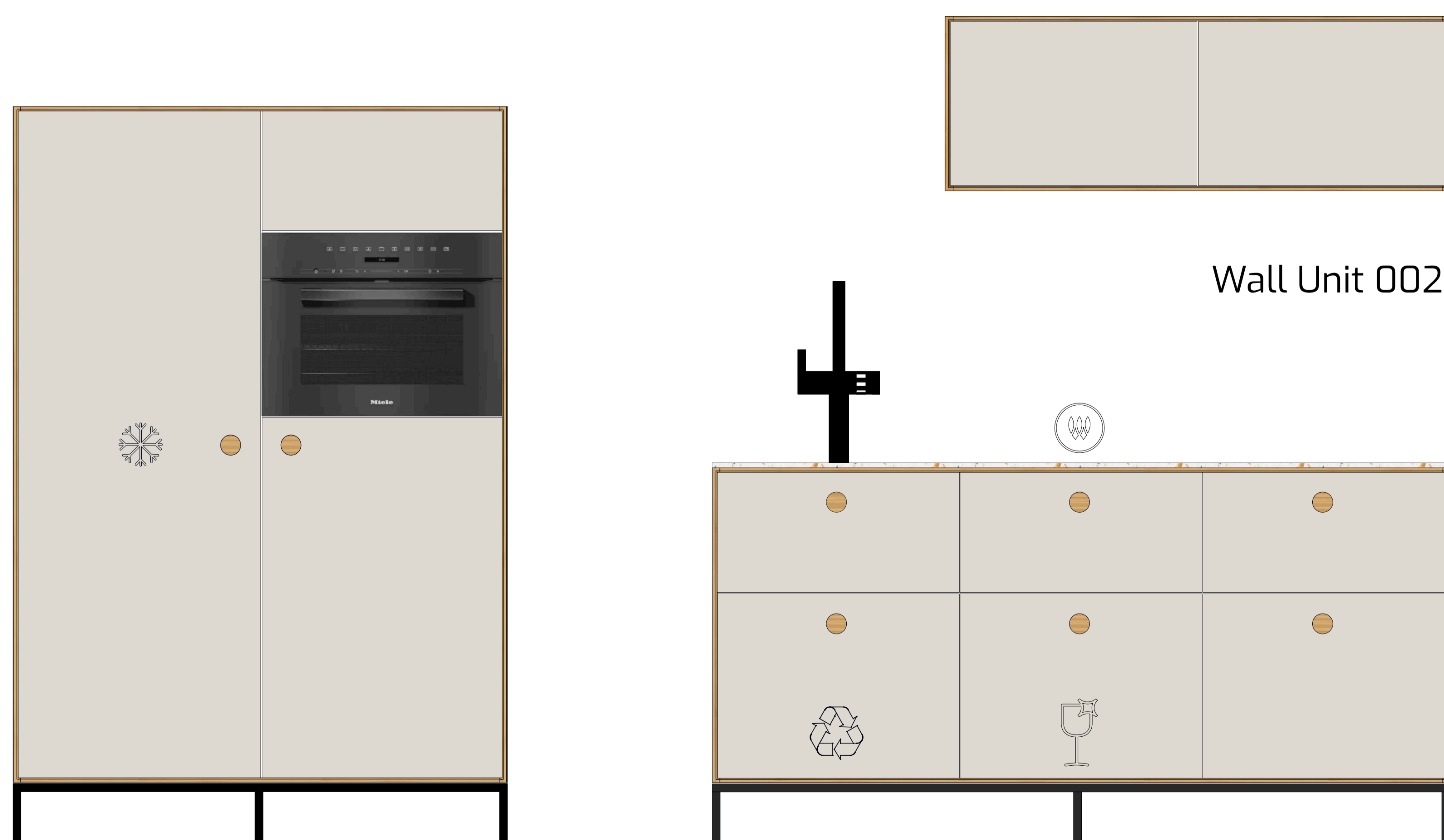

Tall Unit 008

Base Unit 003

Wall Unit 002



# KOMBINATIONEN +++ COMBINATIONS

TINY KITCHEN «OFFICE»2024 **neuvermoebelt**®

Legende:  Kochfeld mit Abzug,  Geschirrspüler,  Mülltrennsystem,  Kühlschrank,  Backofen,  Weinkühlchrank,

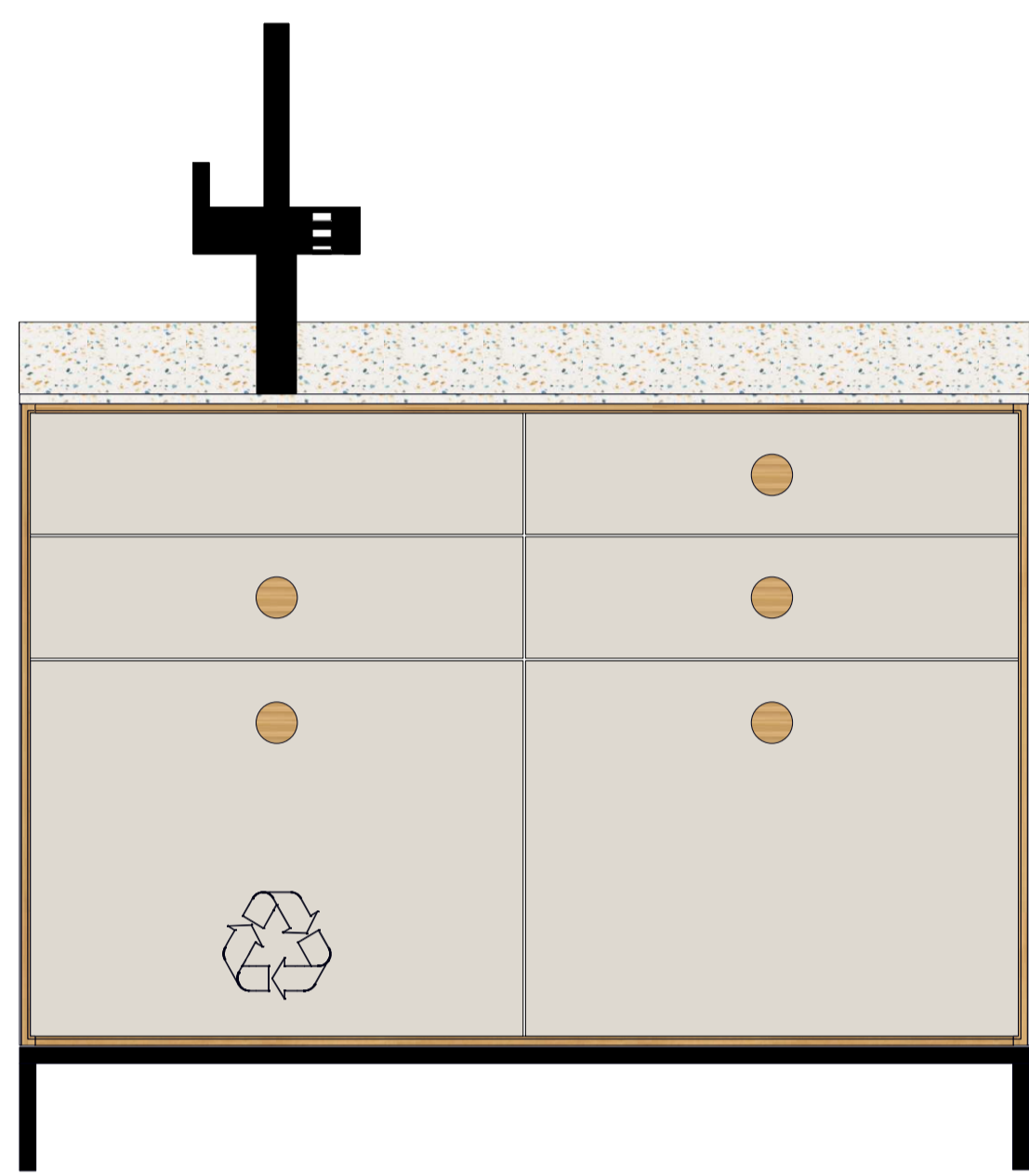

Base Unit 023

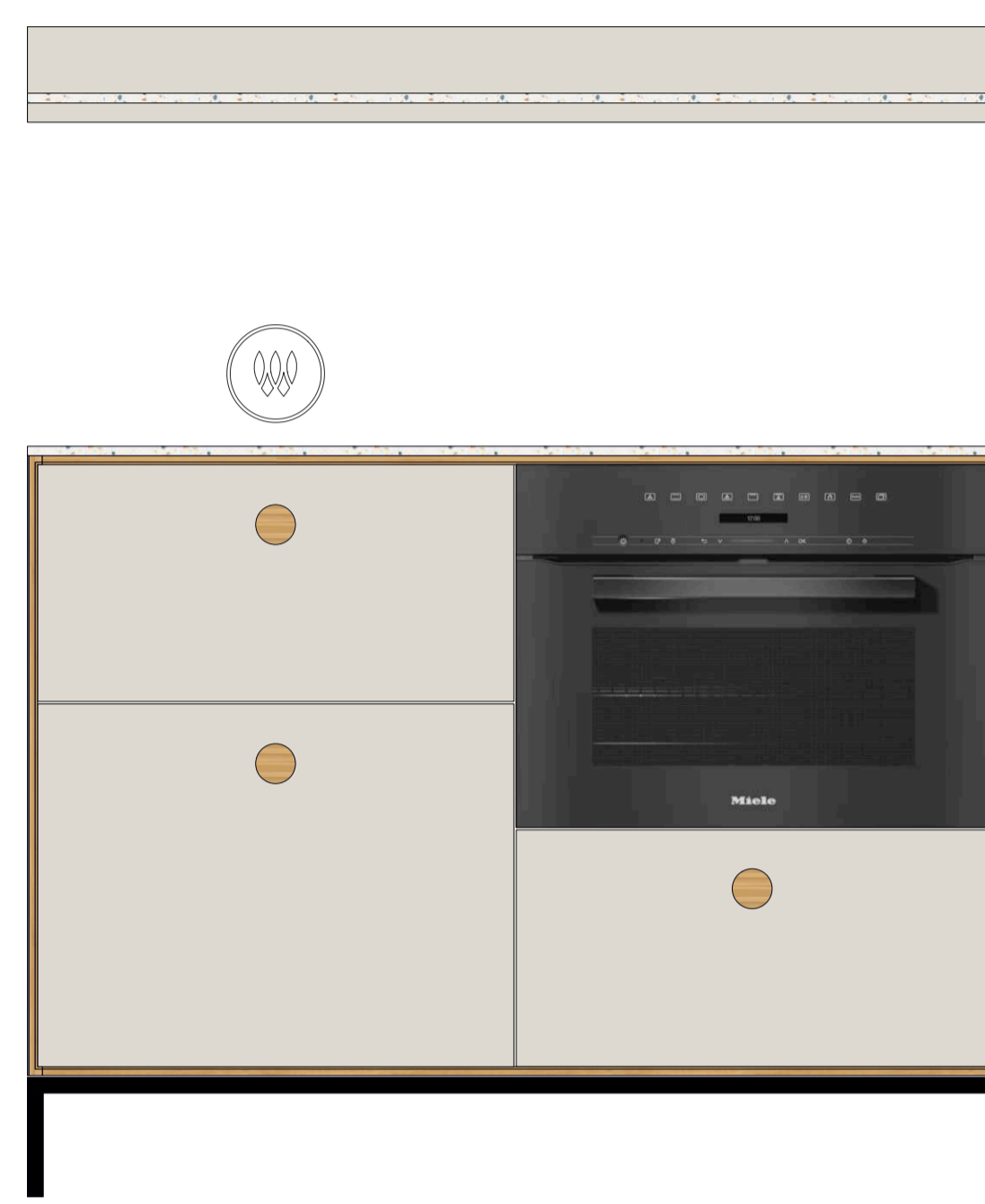

Base Unit 028

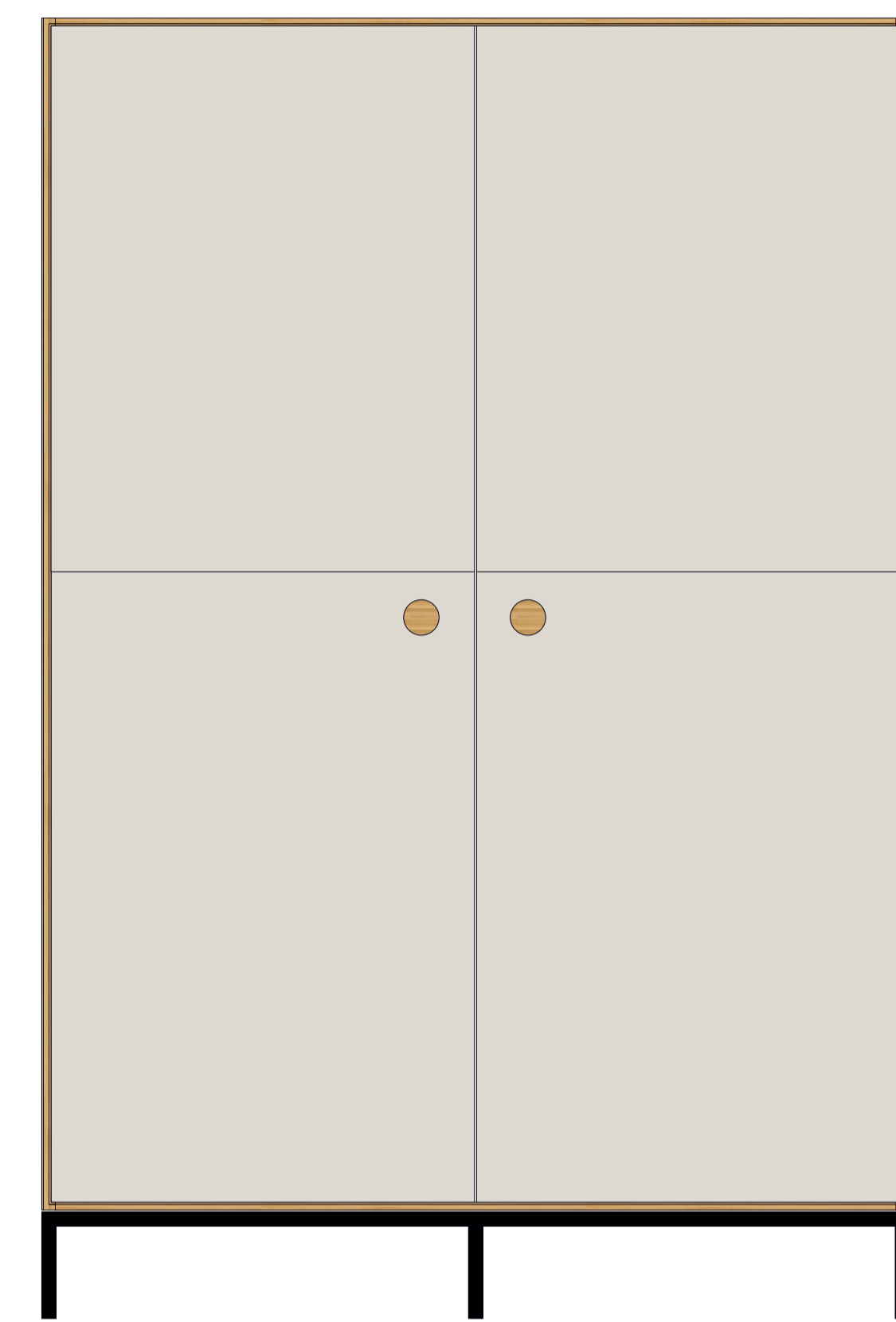

Base Unit 007



Tall Unit 008

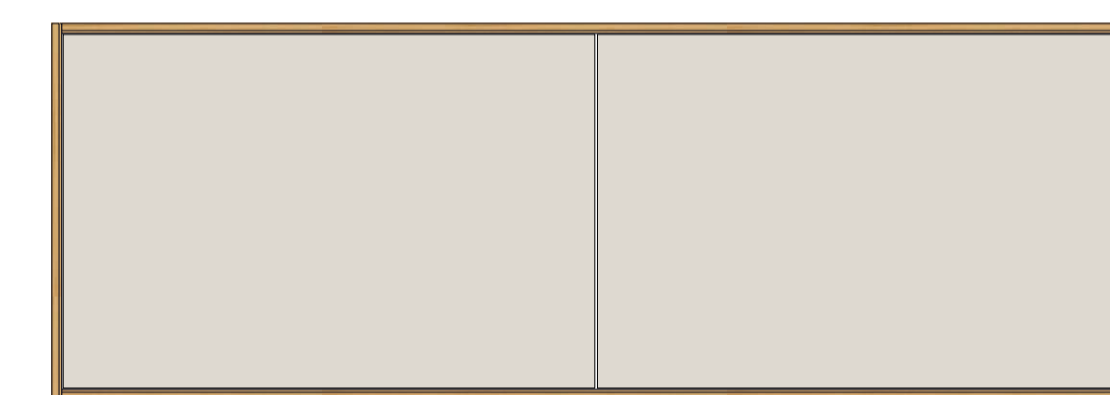

Wall Unit 002

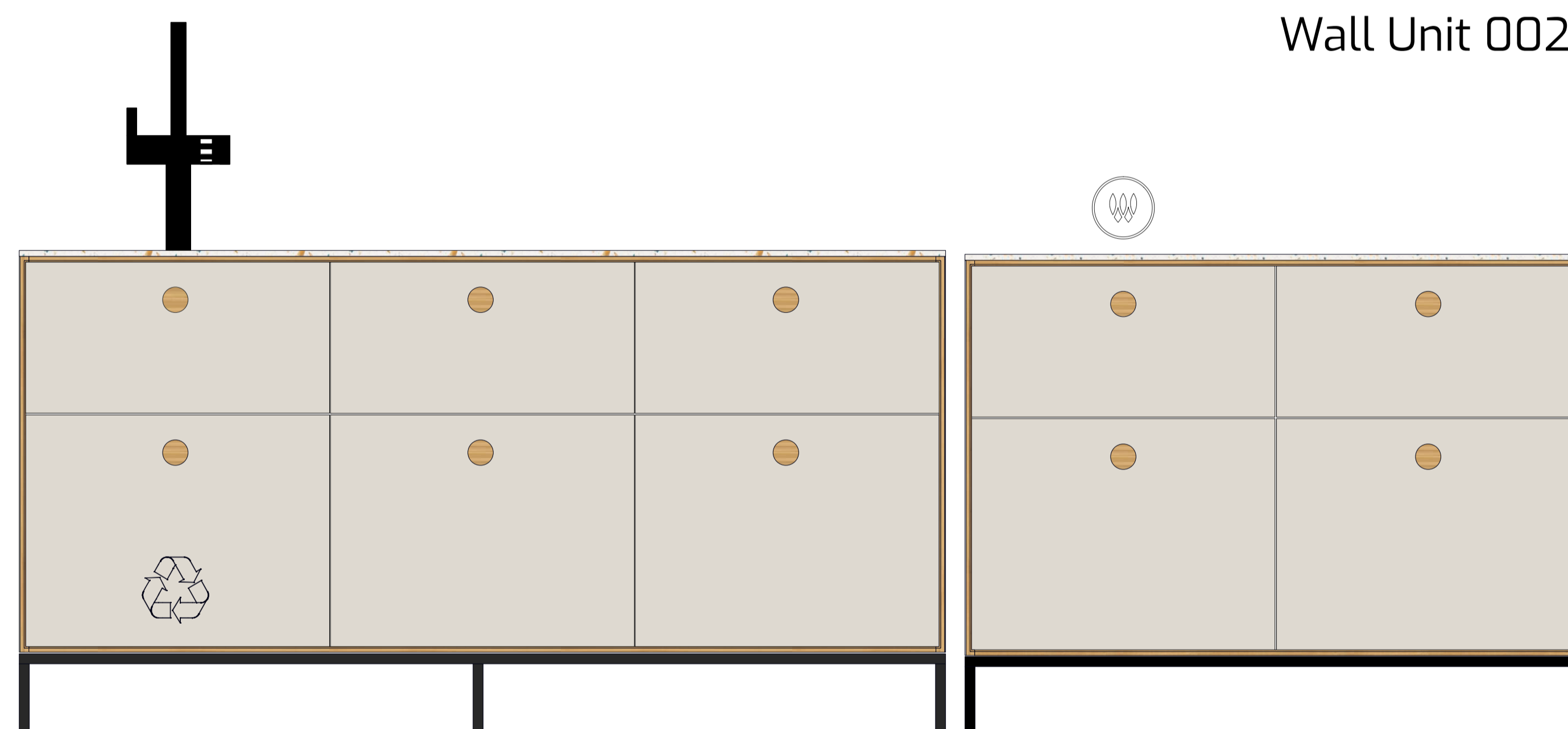

Base Unit 010

Base Unit 026



Tall Unit 008

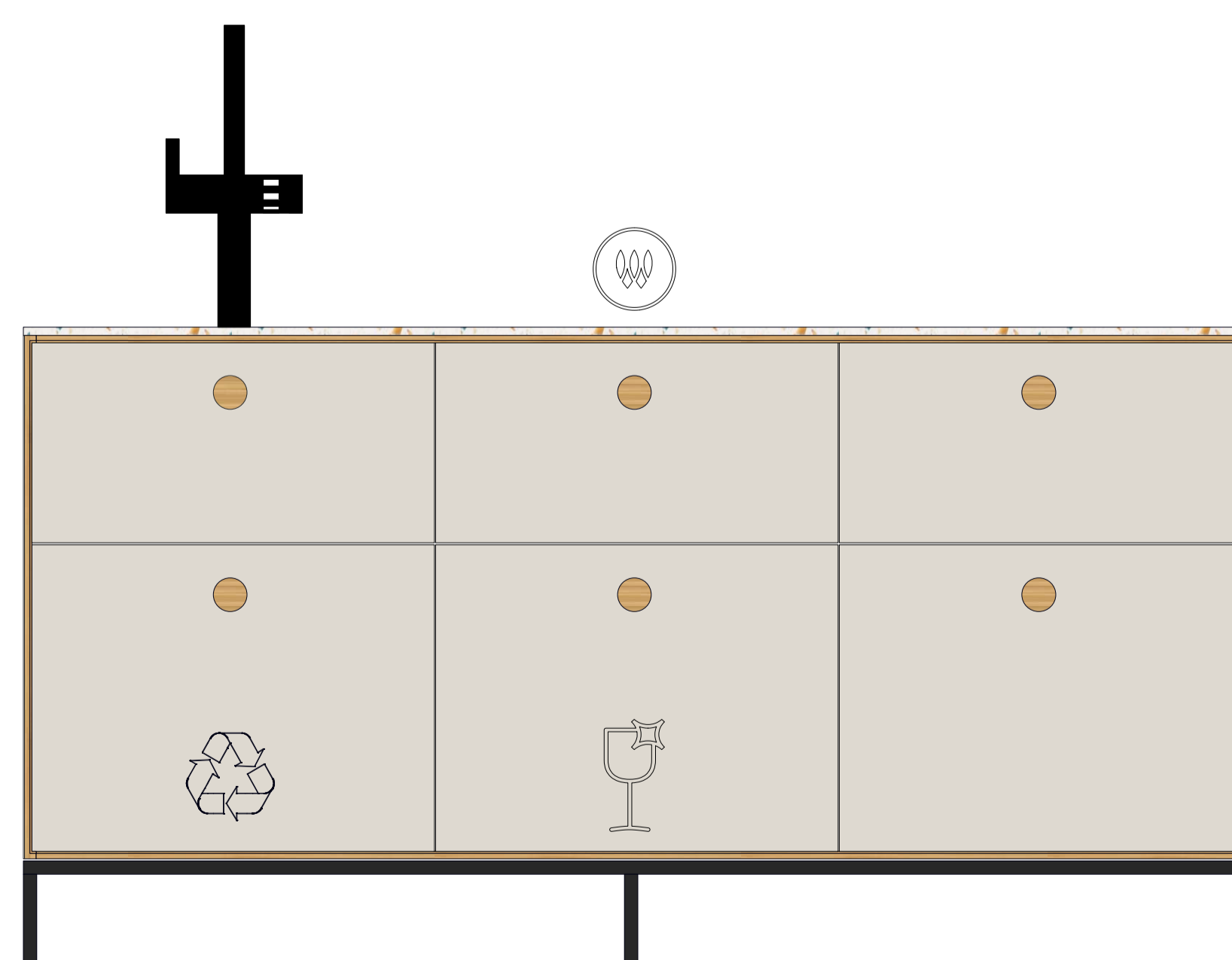

Base Unit 002

# SCHUBLADEN +++ DRAWERS

TINY KITCHEN «OFFICE»2024 **neuvermoebelt**®

BAMBUS, WALNUSS, RÄUCHEREICHE +++ BAMBOO, WALNUT, SMOKED OAK



INNENSCHUBLADE  
HOCH  
+++  
INNER DRAWER HIGH



INNENSCHUBLADE  
HOCH  
+++  
INNER DRAWER HIGH



INNENSCHUBLADE  
MITTEL  
+++  
INNER DRAWER MEDIUM



INNENSCHUBLADE  
MITTEL  
+++  
INNER DRAWER MEDIUM

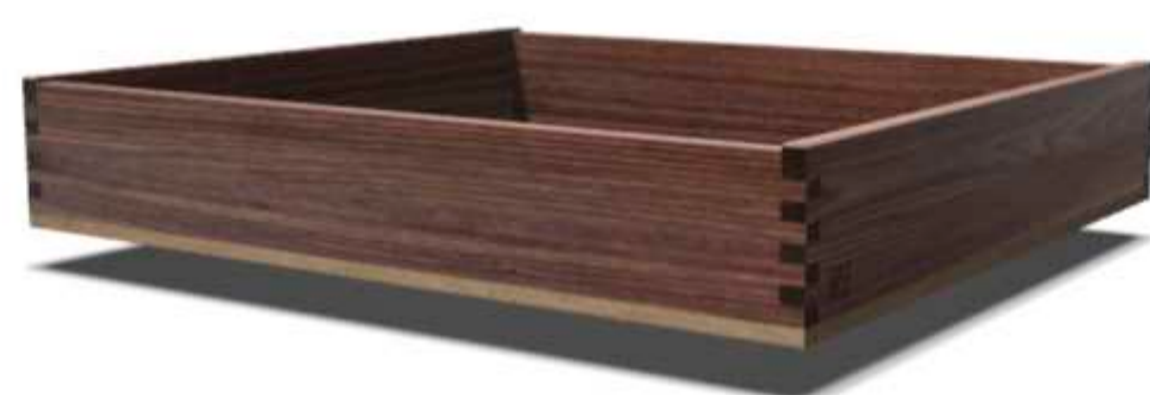

INNENSCHUBLADE  
NIEDRIG  
+++  
INNER DRAWER LOW



INNENSCHUBLADE  
HOCH  
+++  
INNER DRAWER LOW



INNENSCHUBLADE  
HOCH  
+++  
INNER DRAWER LOW



INNENSCHUBLADE  
MITTEL  
+++  
INNER DRAWER MEDIUM



GLAS INNENSCHUBLADE  
NIEDRIG  
+++  
GLAS INNER DRAWER LOW

NUR IN WALNUSS, RÄUCHEREICHE ERHÄLTlich  
ONLY AVAILABLE IN WALNUT, SMOKED OAK



GLAS INNENSCHUBLADE  
MITTEL  
+++  
GLASS INNER DRAWER

NUR IN WALNUSS, RÄUCHEREICHE ERHÄLTlich  
ONLY AVAILABLE IN WALNUT, SMOKED OAK



SYPHON SCHUBLADE  
NIEDRIG  
+++  
SIPHON DRAWER LOW

# SCHUBLADENEINTICHTUNG +++ DRAWER INSERT

Yellow = \* VARIABEL ++

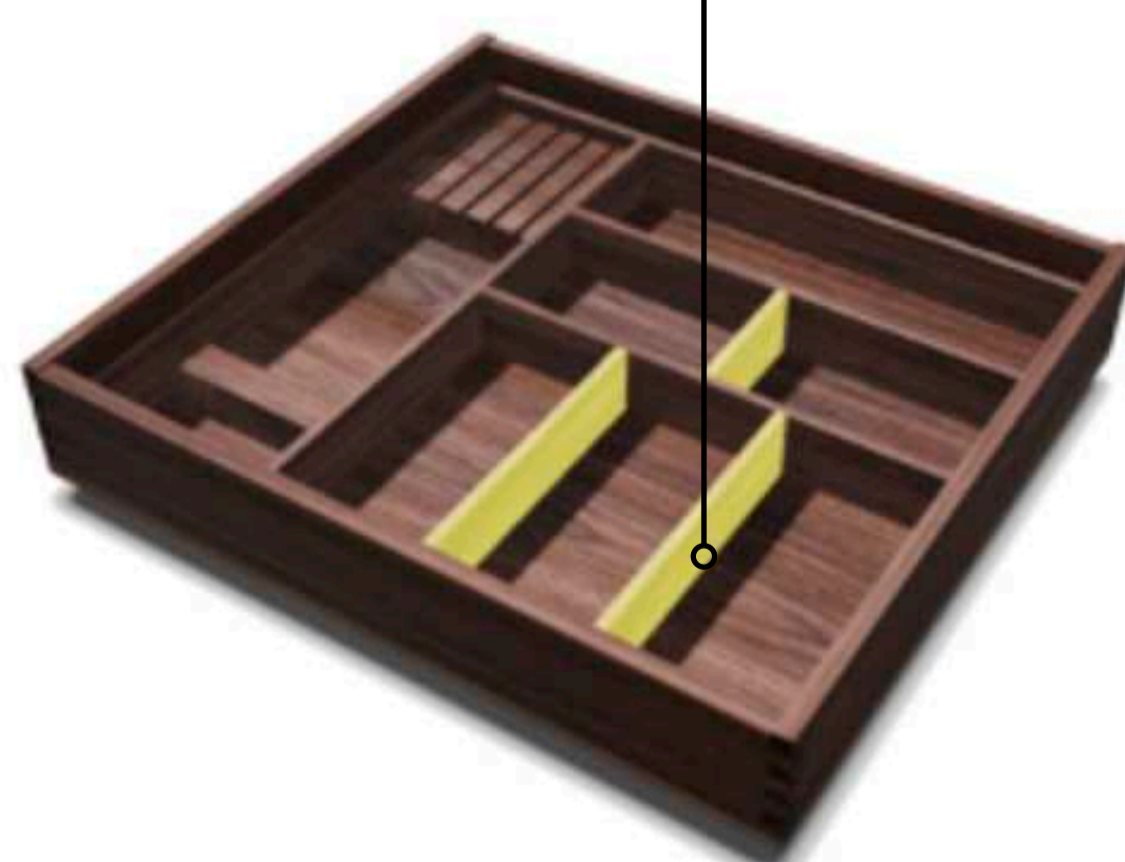

INNENSCHUBLADE  
HOCH  
+++  
INNER DRAWER HIGH



INNENSCHUBLADE  
HOCH  
+++  
INNER DRAWER HIGH



GEWÜRZ SCHUBLADE  
MITTEL  
+++  
SPICE DRAWER MEDIUM



GEWÜRZGLÄSE  
R  
+++  
SPICE GLASSES



BILLUND, 12cm Duo  
GEWÜRZMÜHLE  
+++  
SPICE GRINDERS



BILLUND, LAVENDEL 12cm  
GEWÜRZMÜHLE  
+++  
SPICE GRINDERS



BILLUND, MASALA 12cm  
GEWÜRZMÜHLE  
+++  
SPICE GRINDERS



BILLUND, BEETROOT 12cm  
GEWÜRZMÜHLE  
+++  
SPICE GRINDERS



BLUEBEERY 12cm Duo  
GEWÜRZMÜHLE  
+++  
SPICE GRINDERS



PAPRIKA 12cm Duo  
GEWÜRZMÜHLE  
+++  
SPICE GRINDERS



Schneidbrett 400  
BAMBUS  
+++  
Cutting board 400  
BAMBOO

# SHELFS & BACKWALLS

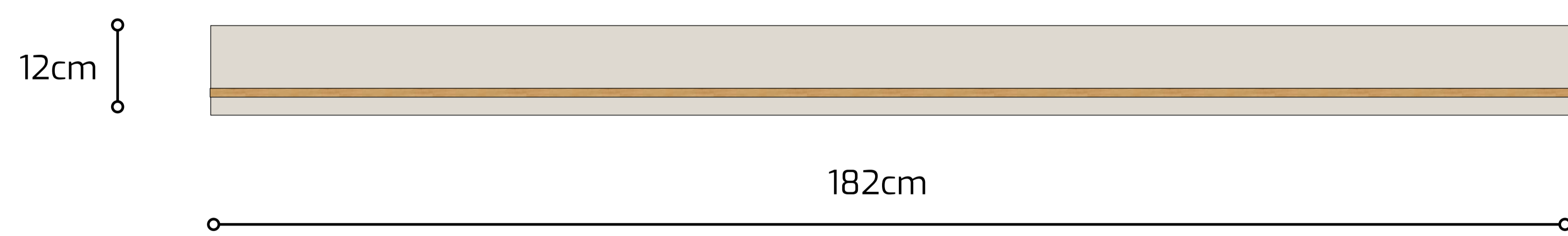
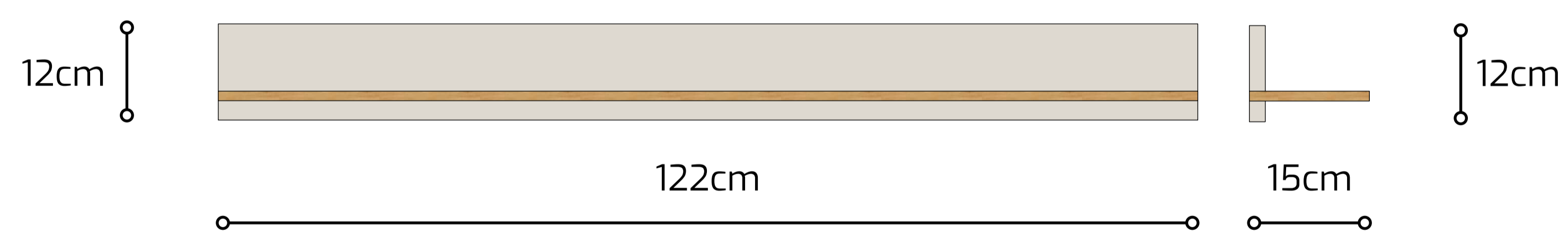
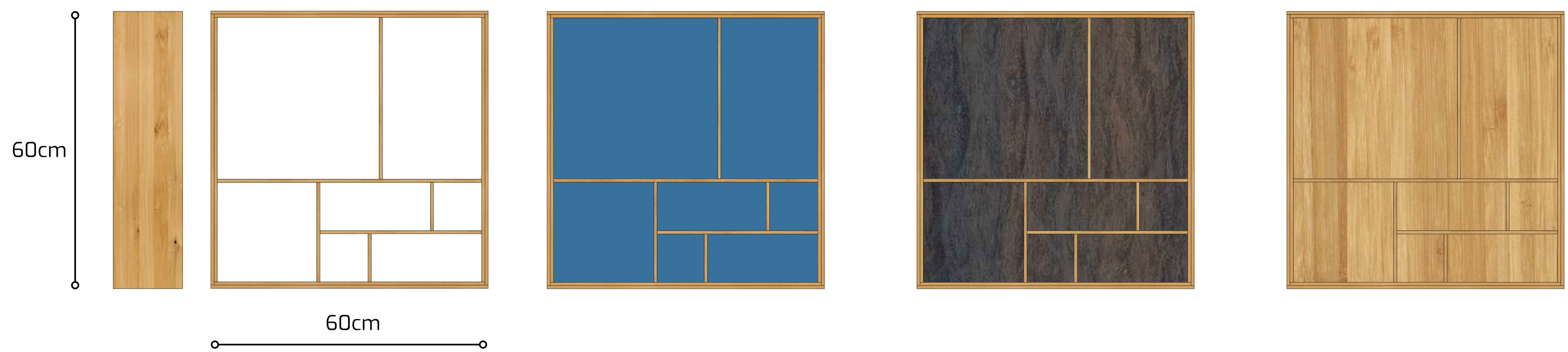

# CUPBOARDS

TINY KITCHEN «OFFICE»2024 **neuvermoebelt**®

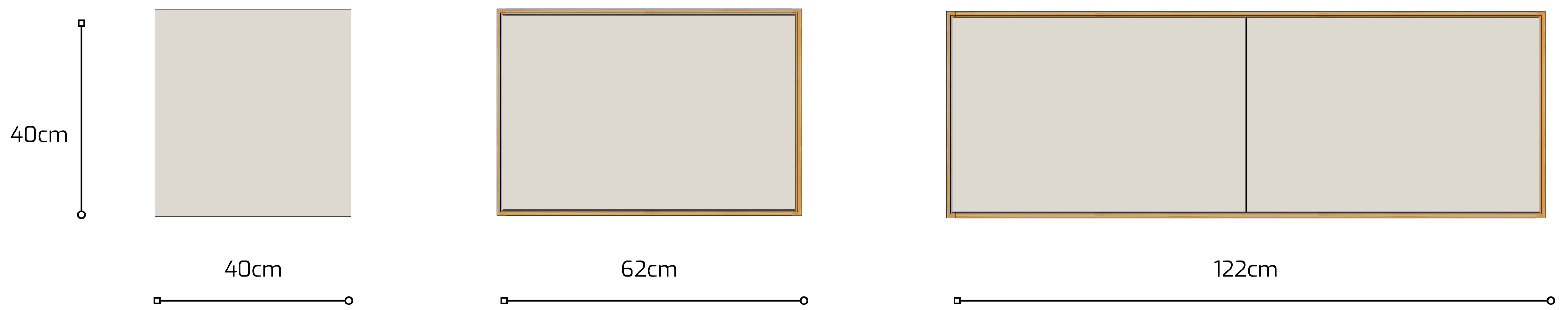

Wall Unit 001

Wall Unit 002

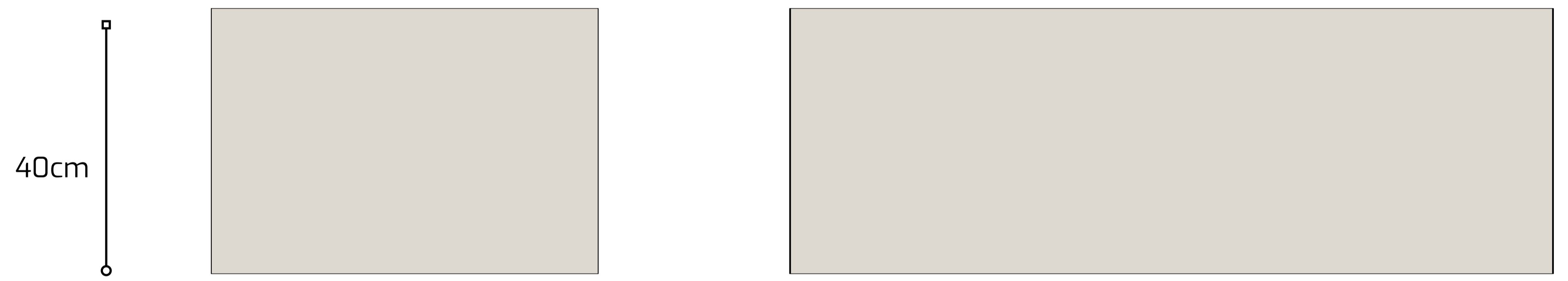

Wall Unit 003

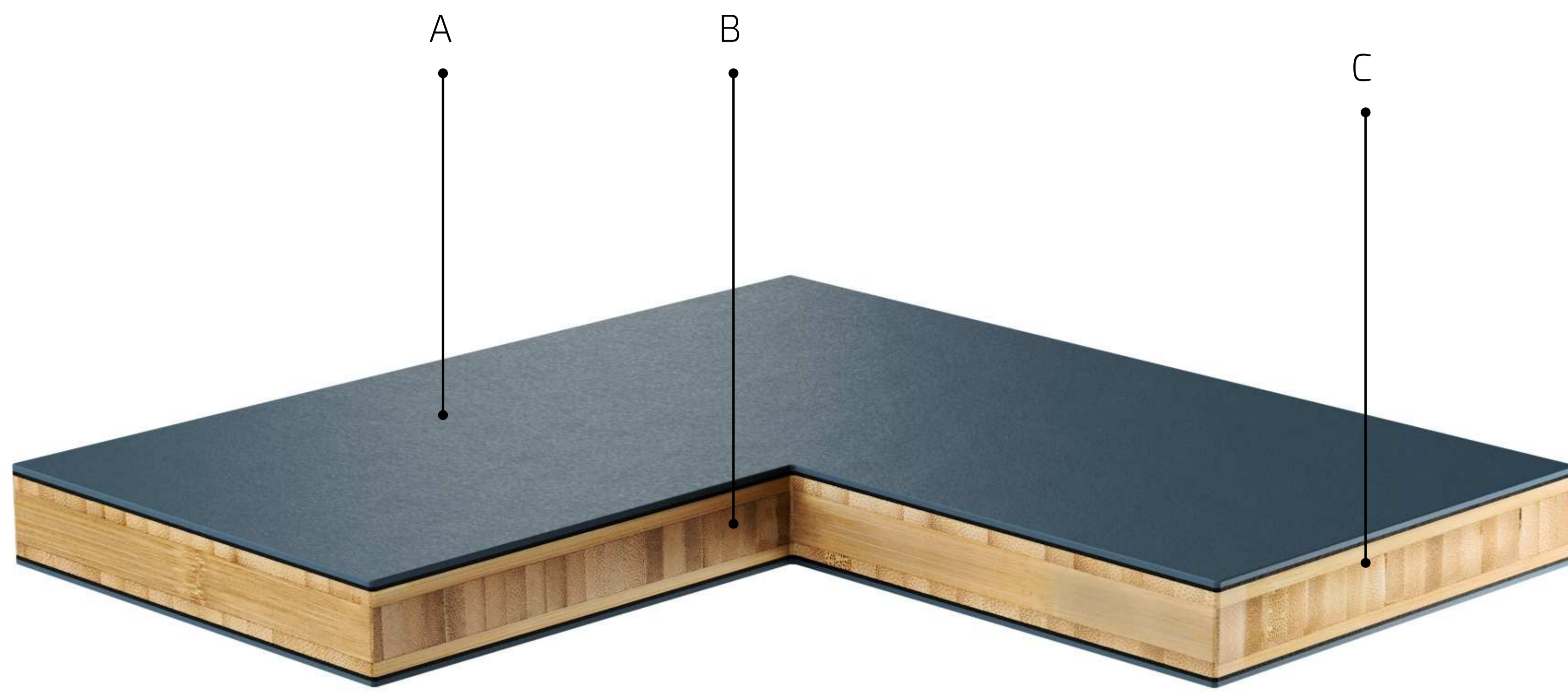

A = Front = 2mm Forbo Desktop Linoleum  
 B = Kern = Bambus 3 Schichtplatte 16mm  
 C= Kante = Bambus 3 Schichtplatte geölt  
 D = Rückseite 2mm Linoleum

A = Front = 2mm Forbo Desktop Linoleum  
 B = Core = Bamboo 3 ply board 16mm  
 C= Edge = Bamboo 3-layer board oiled  
 D = Back side 2mm Linoleum

## PFLEGE UND WARTUNG

Die Linoleumfronten können mit einem weichen, in warmem Wasser angefeuchteten Tuch und einem milden Haushaltsreiniger gereinigt werden. Anschließend mit einem trockenen, weichen Tuch nachreiben.

Wir empfehlen unsere auf die Oberflächen abgestimmten Pflegemittel.

## CARE AND MAINTENANCE

The linoleum fronts can be cleaned with a soft cloth dampened in warm water and a mild household cleaner. Wipe with a dry, soft cloth.

We recommend using our surface care products.

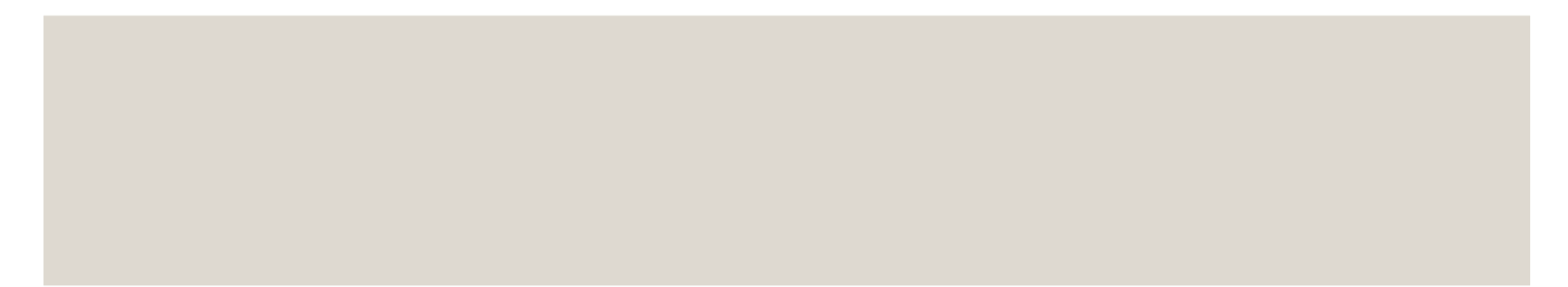

MUSHROOM



PEPPLE



SMOKEY BLUE



OLIVE



CHARCOAL



SALSA



POWDER



AQUAVERT



VAPOUR



IRON



PEWTER



CONIFER



BURGUNDY



ORANGE BLAST



PISTACHIO



MIDNIGHT BLUE

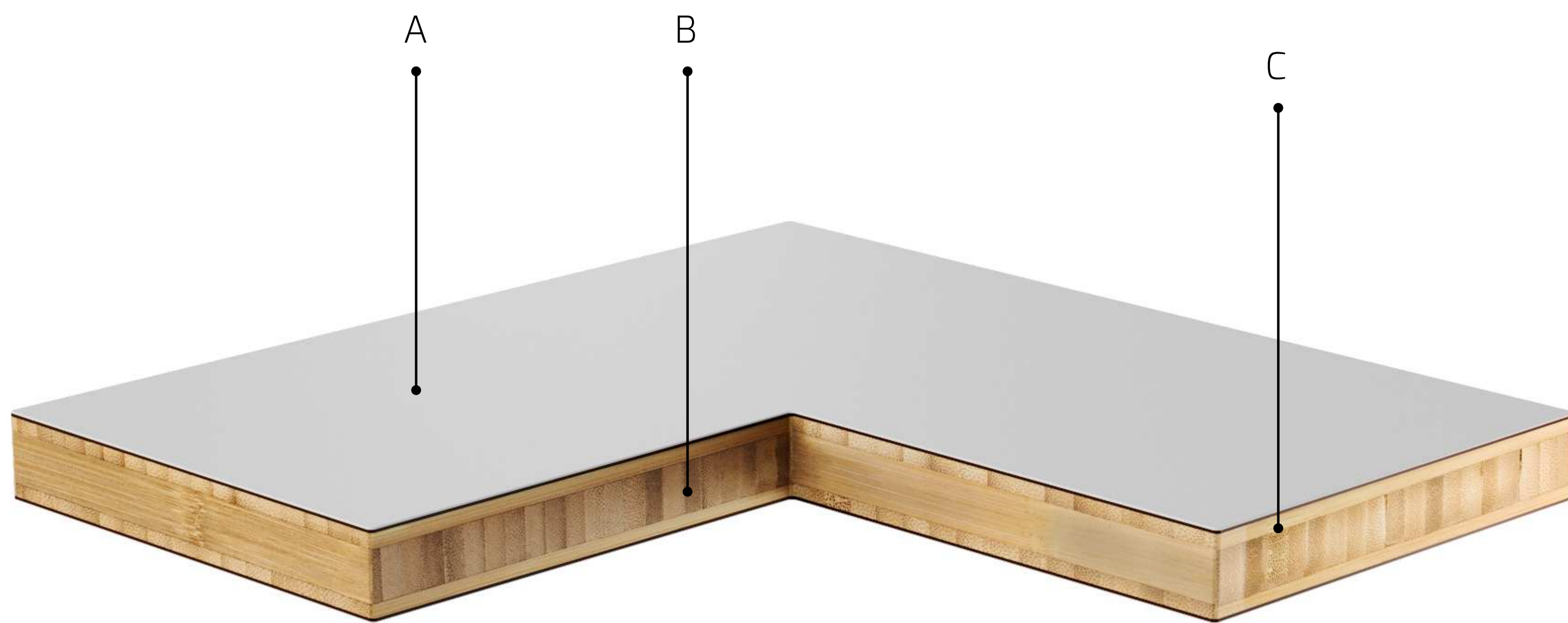

A = Front = 0,8mm Fenix® NTM  
 B = Kern = Bambus 3 Schichtplatte 16mm  
 C = Kante = Bambus 3 Schichtplatte geölt  
 D = Rückseite Fenix Gegenzug

A = Front = 0,8mm Fenix® NTM  
 B = Core = Bamboo 3 ply board 16mm  
 C = Edge = Bamboo 3-layer board oiled  
 D = Back side Fenix counter-move

## PFLEGE UND WARTUNG

Die Fenix® Fronten können mit einem weichen, in warmem Wasser angefeuchteten Tuch und einem milden Haushaltsreiniger gereinigt werden. Anschließend mit einem trockenen, weichen Tuch nachreiben.

Wir empfehlen unsere auf die Oberflächen abgestimmten Pflegemittel.

## CARE AND MAINTENANCE

The Fenix® fronts can be cleaned with a soft cloth dampened in warm water and a mild household cleaner. Wipe with a dry, soft cloth.

We recommend using our surface care products.

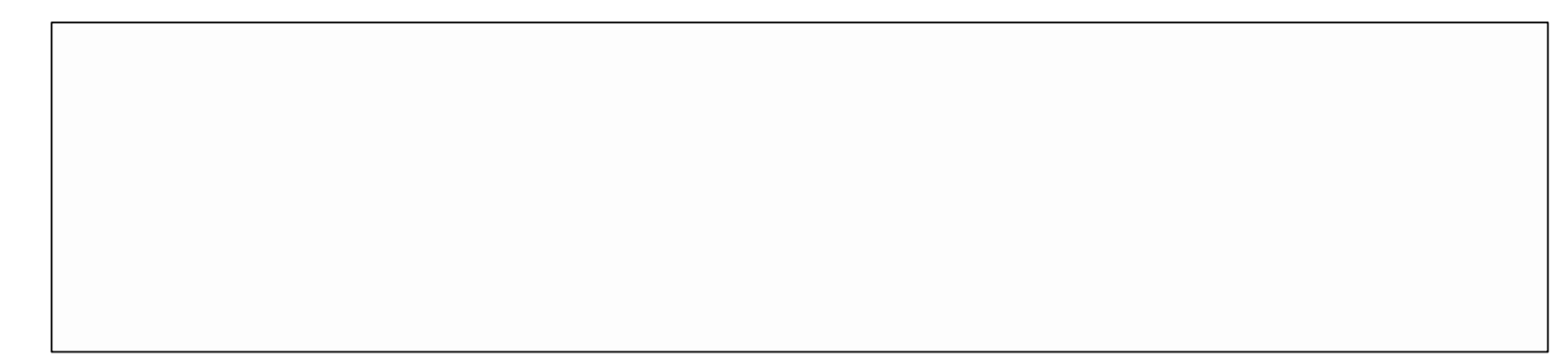

BIANCO KOS 0032



GRIGIO ANTRIM 0752



BEIGE ARIZONA 0748



CASTORO OTTAWA 0717



VERDE COMODORO 0750



BLU FES 0754



VIOLA OPRISSA 0790



GIALLO EVORA 0791



GRIGIO EFESO 0725



ROSSO NAMIB 0789



GRIGIO LONDRA 0718



GRIGIO BROMO 0724



ROSSO JAIPUR 0751



NERO INGO 0720

# FRONT FACTS \_ LAMINATE

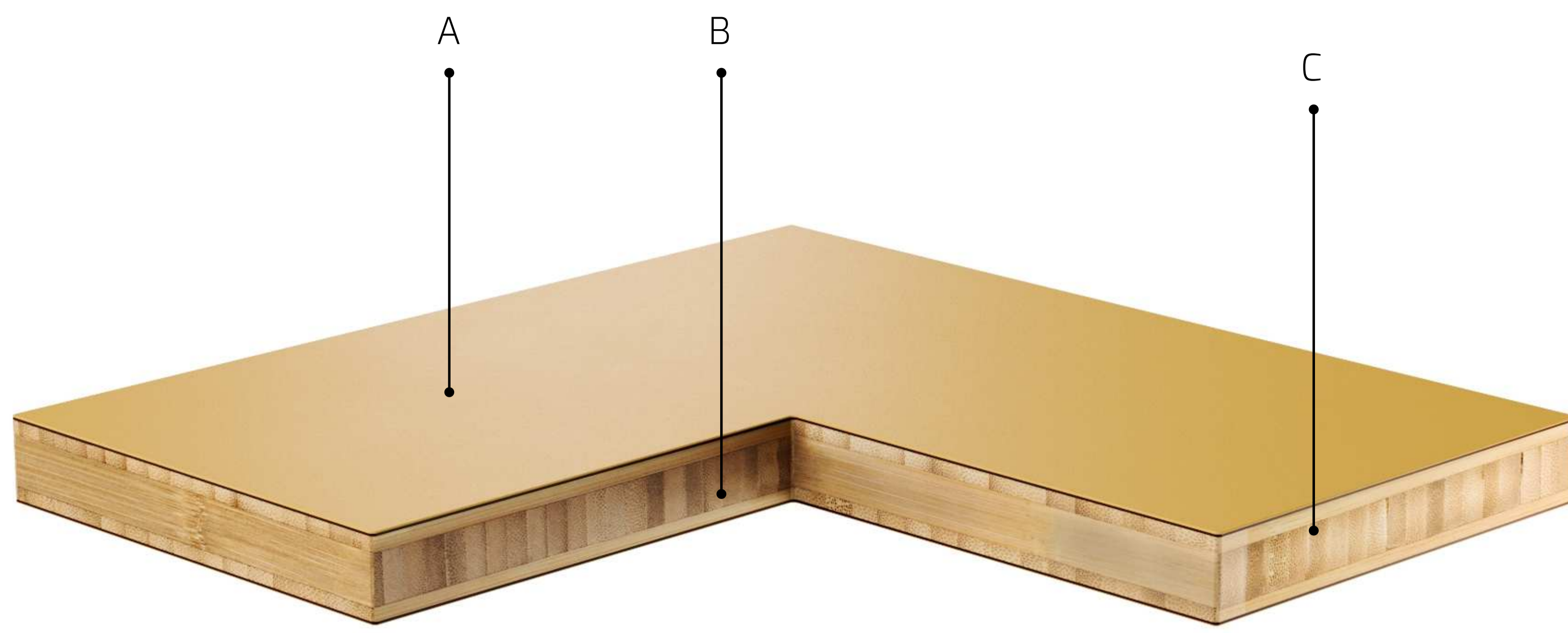

A = Front = 0,6 mm Laminat  
 B = Kern = Bambus 3 Schichtplatte 16mm  
 C = Kante = Bambus 3 Schichtplatte geölt  
 D = Rückseite Gegenzug

A = Front = 0,6 mm Laminat  
 B = Core = Bamboo 3 ply board 16mm  
 C = Edge = Bamboo 3-layer board oiled  
 D = Back side Laminat counter-move

## PFLEGE UND WARTUNG

Die Laminat Fronten können mit einem weichen, in warmem Wasser angefeuchteten Tuch und einem milden Haushaltsreiniger gereinigt werden. Anschließend mit einem trockenen, weichen Tuch nachreiben.

Wir empfehlen unsere auf die Oberflächen abgestimmten Pflegemittel.

## CARE AND MAINTENANCE

The laminate fronts can be cleaned with a soft cloth dampened in warm water and a mild household cleaner. Wipe with a dry, soft cloth.

We recommend using our surface care products.

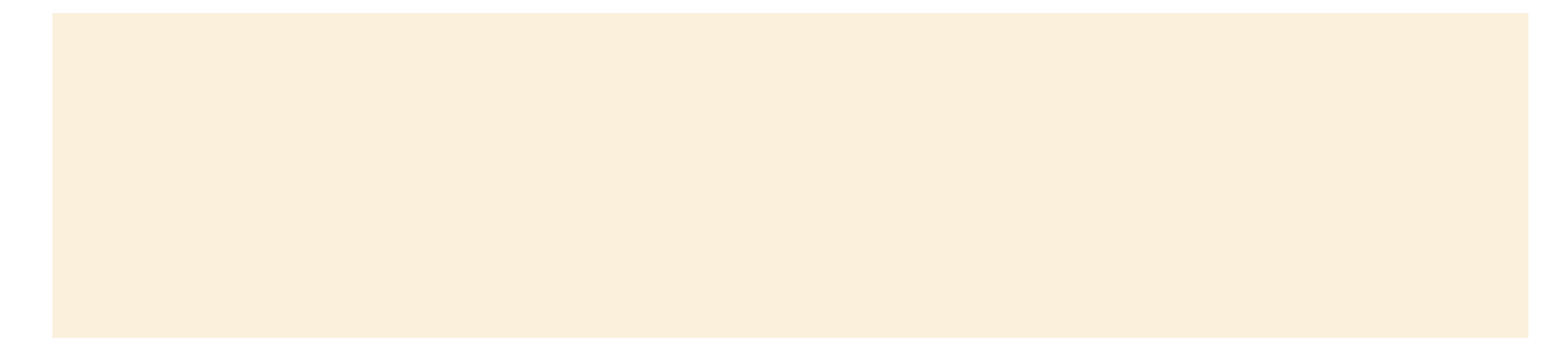

COTTON BEIGE



PISTACHIOS GREEN



FJORD GREEN



CURRY



SIGNAL RED



BRILLANT YELLOW



SMOKEY BLUE



KASCHMIR



GLACIER BLUE



NIAGARA GREEN



CARAMEL



FLAMINGO



DELFT BLUE



CHINA RED



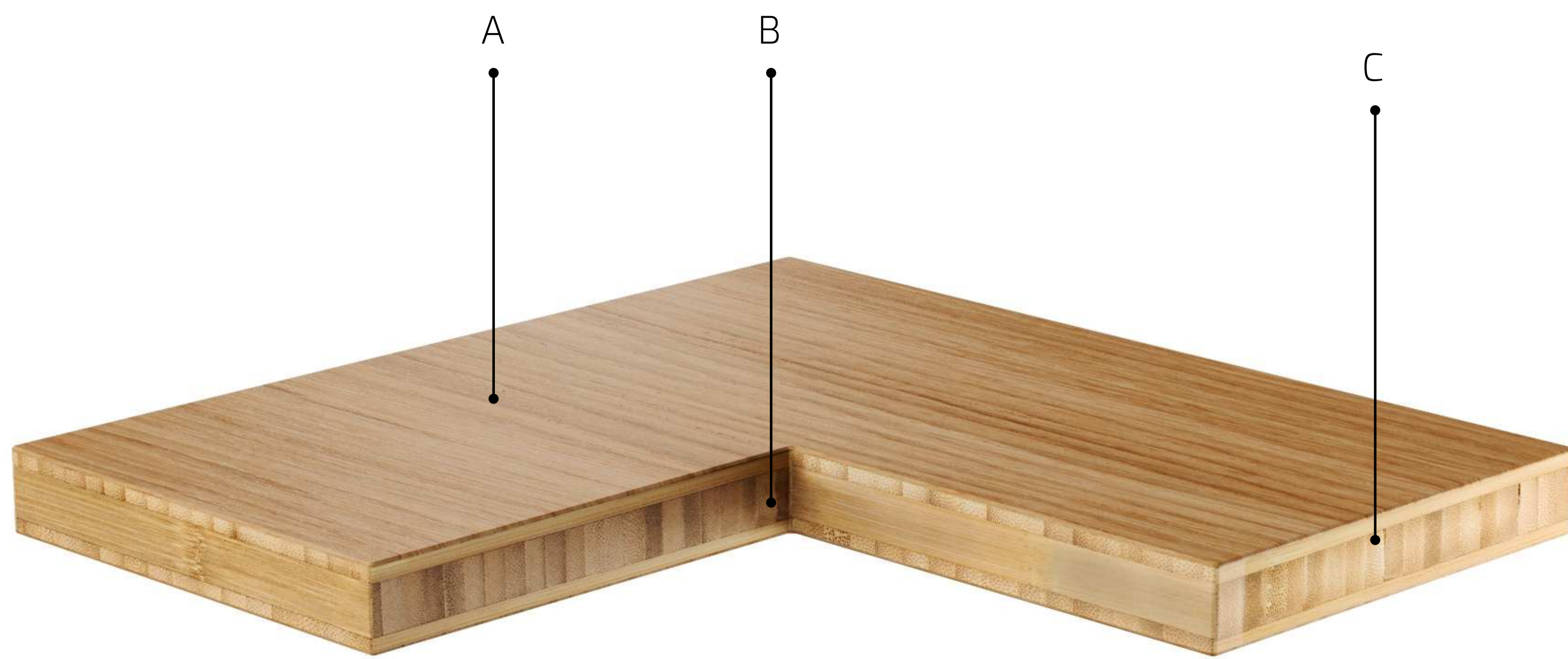

A = Front = 0,8 mm Holzfurnier  
 B = Kern = Bambus 3 Schichtplatte 16mm  
 C = Kante = Bambus 3 Schichtplatte geölt  
 D = Rückseite 0,8 mm Holzfurnier

A = Front = 0,8 mm Wood Veneer  
 B = Core = Bamboo 3 ply board 16mm  
 C = Edge = Bamboo 3-layer board oiled  
 D = Back side 0,8 mm Wood Veneer

**PFLEGE UND WARTUNG**

Die Holzoberfläche kann mit einem weichen, mit warmem Wasser angefeuchteten Tuch und einem milden Haushaltsreiniger (nicht fettlöslich ! ), vorzugsweise Seife, gereinigt werden. Anschließend mit einem trockenen, weichen Tuch nachreiben. Von Zeit zu Zeit mit unserem Holzpflegemittel intensiv pflegen, damit das Holz nicht austrocknet und leicht nachgeölt wird.

Wir empfehlen unsere speziell auf die Oberflächen abgestimmten Pflegemittel.

**CARE AND MAINTENANCE**

The wood surface can be cleaned with a soft cloth moistened with warm water and a mild household cleaner preferably soap. (not fat soluble!) Then rub with a dry, soft cloth. Occasionally treat with our wood care product to keep the wood does not dry out and is lightly oiled.

We recommend our care products specially formulated for the surfaces.



BAMBUS ECRU

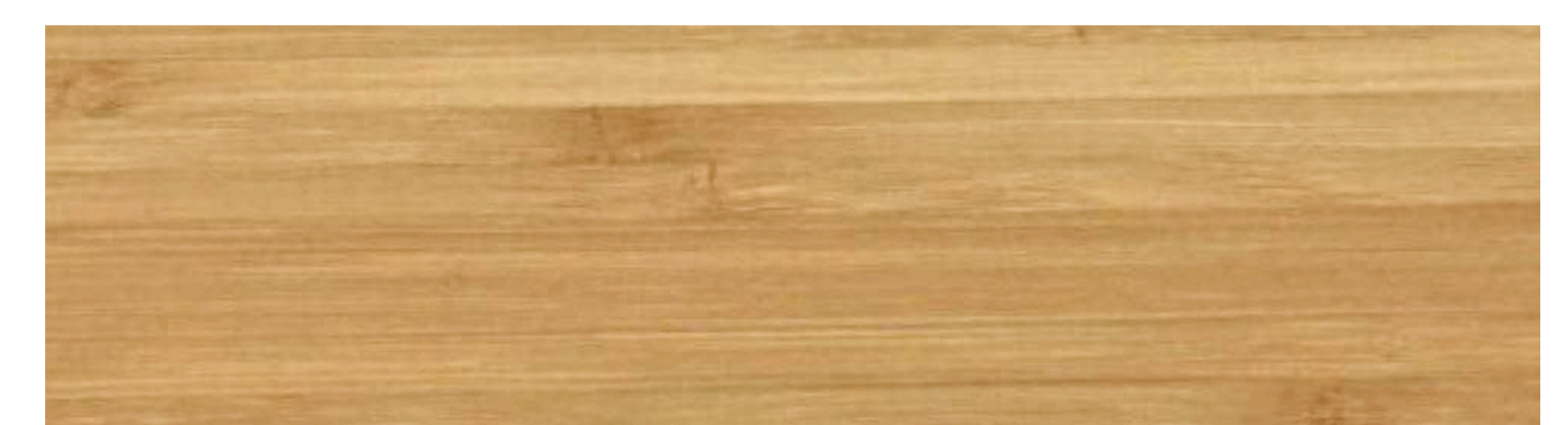

BAMBUS CARMEL

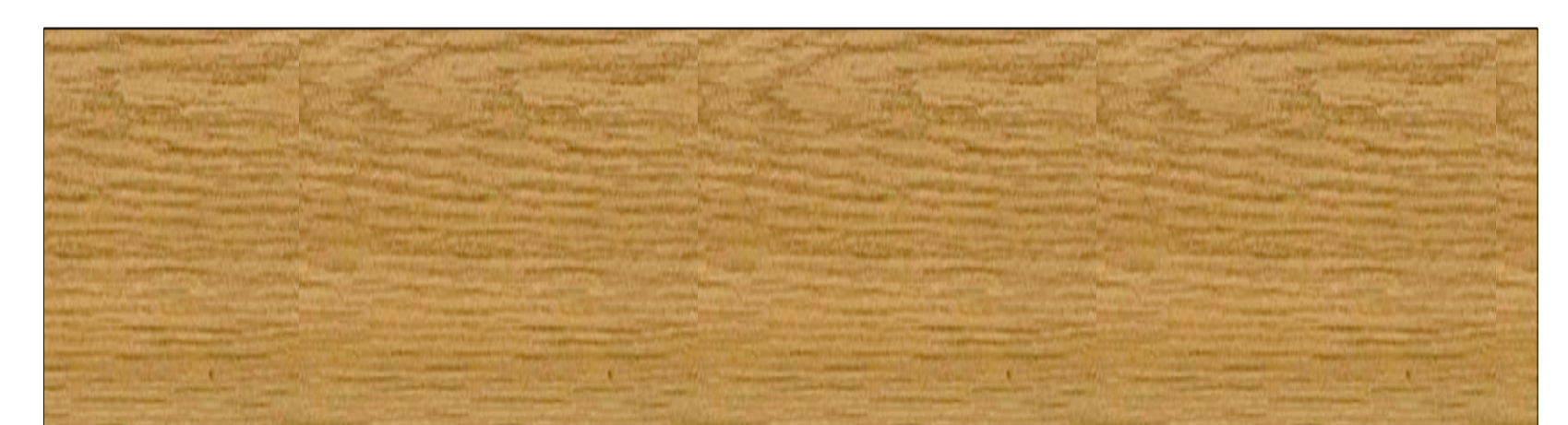

OAK \_ EICHE

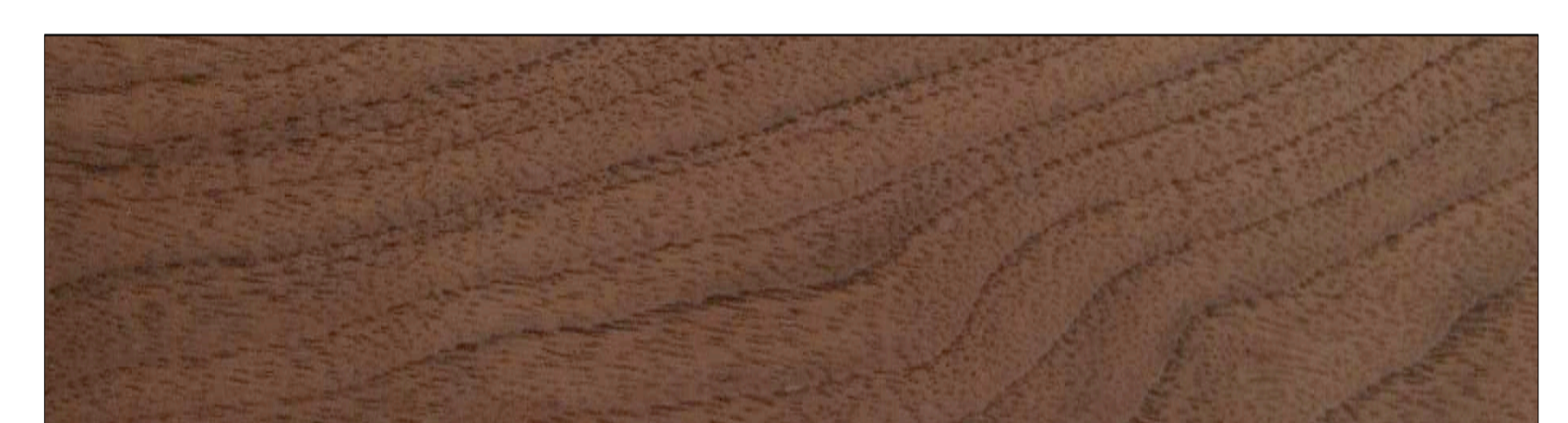

WALNUT \_ WALNUSS

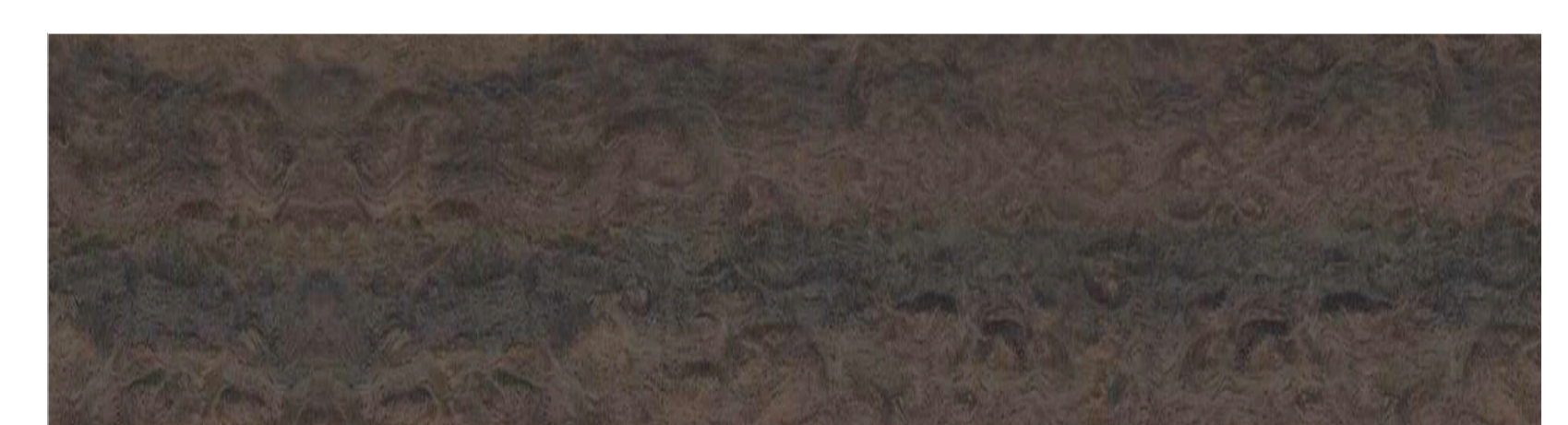

SMOKED OAK \_ RÄUCHEREICHE

# WORK TOP FACTS \_ BAMBOO



**BAMBUS 20MM GEÖLT IN CAMEL ODER ECRU. BAMBOO 20MM OILED IN CAMEL OR ECRU**

## **PFLEGE UND WARTUNG**

Die Holzoberfläche kann mit einem weichen, mit warmem Wasser angefeuchteten Tuch und einem milden Haushaltsreiniger (nicht fettlöslich!), vorzugsweise Seife, gereinigt werden. Anschließend mit einem trockenen, weichen Tuch nachreiben. Von Zeit zu Zeit mit unserem Holzpflegemittel intensiv pflegen, damit das Holz nicht austrocknet und leicht nachgeölt wird.

Wir empfehlen unsere speziell auf die Oberflächen abgestimmten Pflegemittel.

## **CARE AND MAINTENANCE**

The wood surface can be cleaned with a soft cloth moistened with warm water and a mild household cleaner preferably soap. (not fat soluble!)  
Then rub with a dry, soft cloth.  
Occasionally treat with our wood care product to keep the wood does not dry out and is lightly oiled.

We recommend our care products specially formulated for the surfaces.



**BAMBUS ECRU**

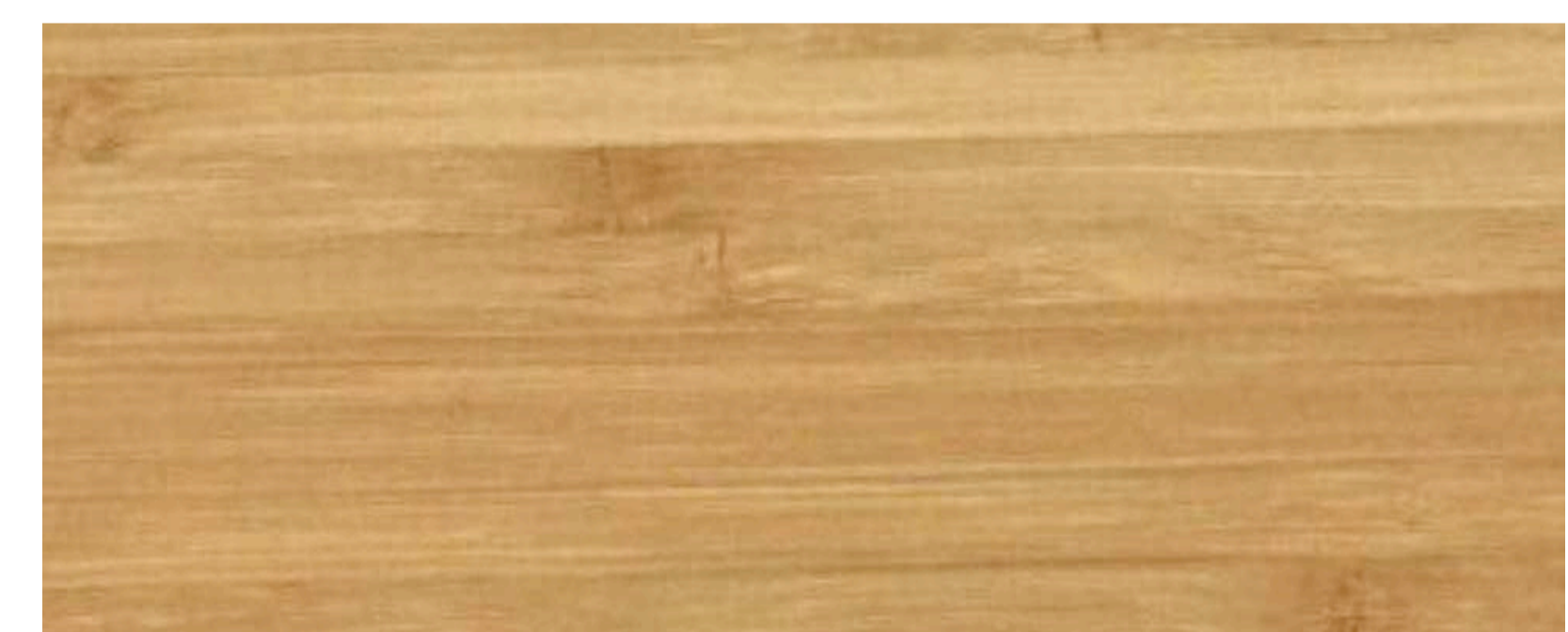

**BAMBUS CAMEL**



## FANTOPLAST® 12/ 20/ 30mm

Fantoplast-Arbeitsplatten in den Stärken 12, 20 und 30 mm werden aus 100 % regionalem Recyclingkunststoff hergestellt und sind zu 100 % recycelbar. Die Produktion erfolgt mit 100% Ökostrom in der Wiener Seestadt.

Fantoplast® ist eine reine Kunststoffplatte mit vielfältigen Designs, die haptisch und optisch mit Corian vergleichbar ist. Die Platten sind in matter und polierter Ausführung erhältlich.

Fantoplast® besteht zur Gänze aus Kunststoffgranulat und kommt ohne Verbundstoffe wie bei Corian® oder Durat® aus. Die verwendeten Materialien stammen aus unterschiedlichen Bereichen wie 3D-Druck, Medizintechnik, Skiliftbau etc.

Fantoplast® bietet eine innovative Möglichkeit, Kunststoffabfälle zu neuen Produkten zu verarbeiten. Dabei wird eng mit regionalen Partnern aus Forschung und Kreislaufwirtschaft zusammengearbeitet.

Die Platten können nach ihrem Nutzungszyklus entweder aufbereitet oder vollständig recycelt werden, ganz im Sinne des Kreislaufprinzips - Kunststoffabfälle einer neuen Nutzung zuzuführen.

Fantoplast worktops in thicknesses of 12, 20 and 30 mm are made from 100% regionally recycled plastic and are 100% recyclable. They are manufactured in Vienna using 100% green electricity.

Fantoplast® is a pure plastic sheet with a variety of designs, comparable in look and feel to Corian. The sheets are available in matte and polished finishes.

Fantoplast® consists entirely of plastic granulate and does not require any composite materials, as is the case with Corian® or Durat®. The materials used come from various sectors such as 3D printing, medical technology, ski lift construction, etc.

Fantoplast® offers an innovative way to transform plastic waste into new products. The company works closely with regional partners in research and recycling.

At the end of their useful life, the sheets can either be reprocessed or completely recycled, in line with the circular economy principle of re-using plastic waste.



COLOUR FRECKLES - NEBULA



COLOUR FRECKLES - SCUBA BLUE



DUO GRAINS - CELESTE



DUO GRAINS - GRAVEL



DUO GRAINS - MARIN

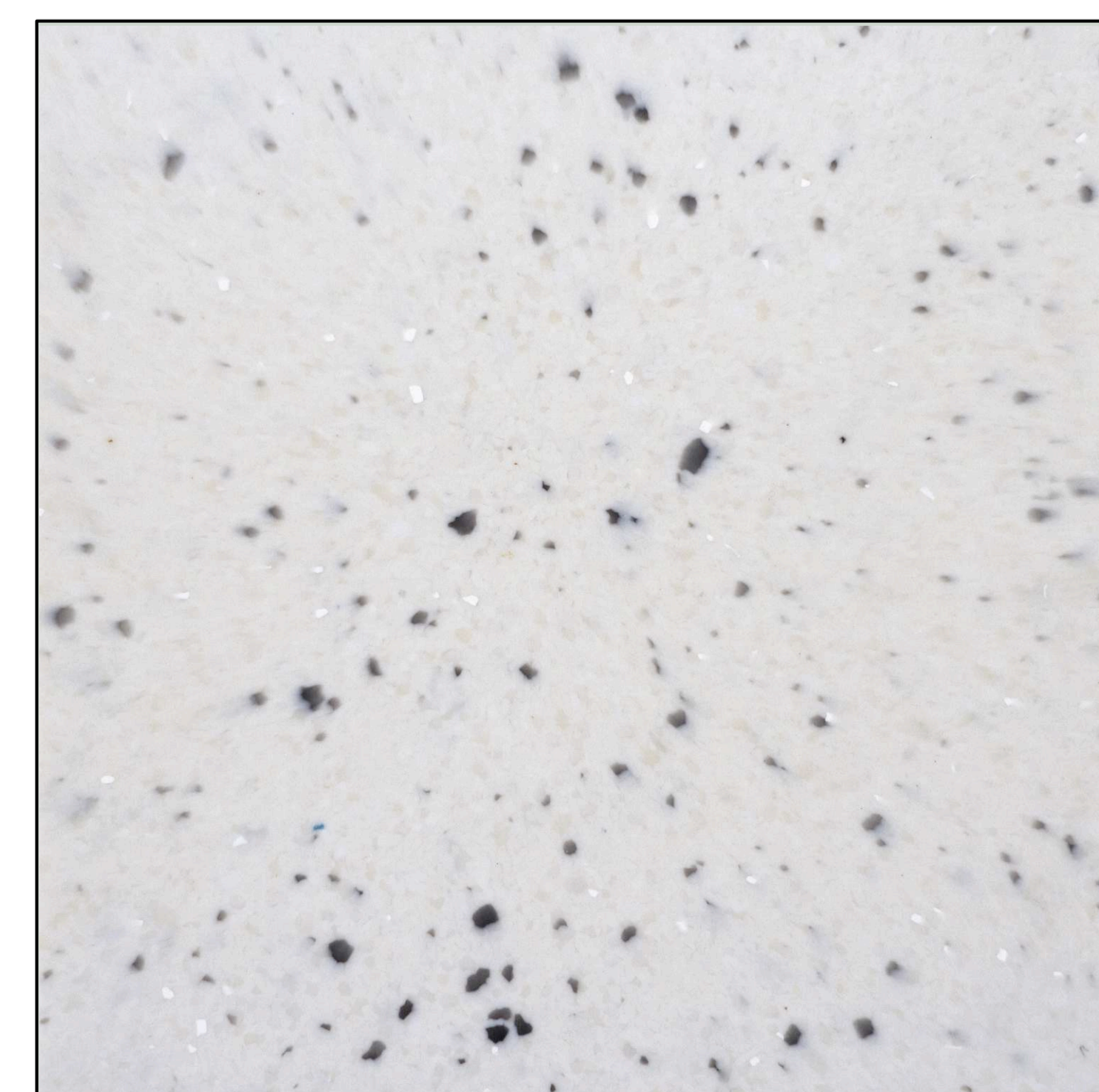

DUO GRAINS - PEBBLE



## DURAT® 12MM

Durat® ist ein Mineralwerkstoff eine Mischung aus Mineralien und Acryl.

Technische Eigenschaften von Durat®:

- Durat® ist ein robustes und strapazierfähiges Material, das stoß- und schnittfest und gegen die meisten Beanspruchungen beständig ist.
- Oberflächen aus Durat® sind fugenlos, so dass sich dort keine Pilze oder Bakterien ansiedeln können.
- Durat® ist einfach zu reinigen, da Flecken nicht eindringen können, sondern auf der Oberfläche bleiben.
- Durat® ist nicht hitzebeständig, man sollte keine heißen Töpfe ohne Untersetzer daraufstellen.

Durat® is a solid surface material made from a mixture of minerals and acrylic.

Technical properties of Durat®:

- Durat® is a tough and durable material that is impact and cut resistant and can withstand most wear and tear.
- Durat® surfaces are seamless, preventing the growth of fungi and bacteria.
- Durat® is easy to clean because stains do not penetrate but remain on the surface.
- Durat® is heat-resistant up to 180 degrees Celsius.

## PFLEGE UND WARTUNG

Die Durat® Oberfläche kann mit einem weichen, mit warmem Wasser angefeuchteten Tuch und einem milden Haushaltsreiniger gereinigt werden.

Anschließend mit einem trockenen, weichen Tuch nachreiben.

Wir empfehlen unsere speziell auf die Oberflächen abgestimmten Pflegemittel.

## CARE AND MAINTENANCE

The Durat® surface can be cleaned with a soft cloth moistened with warm water and a mild household cleaner. Then wipe with a dry, soft cloth.

We recommend our care products specially formulated for the surfaces.



D0100 51 White

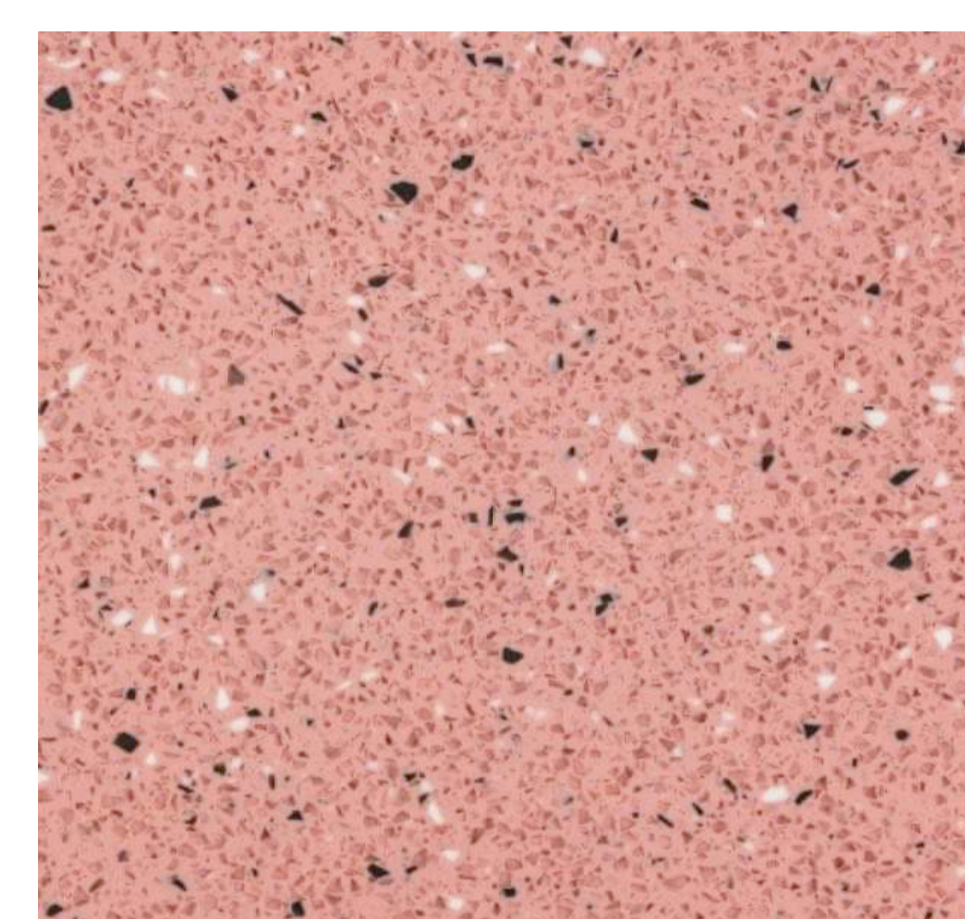

R3014-04 ANTIQUE PINK

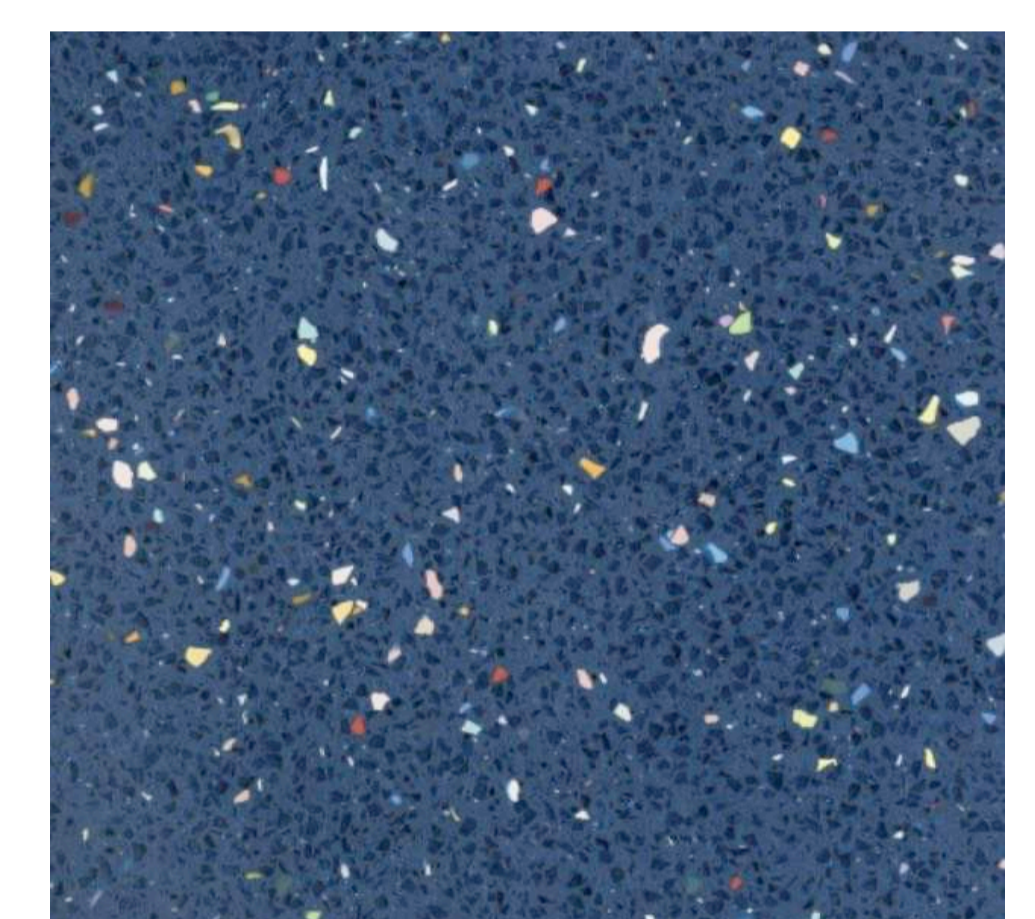

R5003 02 SAPPHIRE BLUE



D0060 53 BLACK

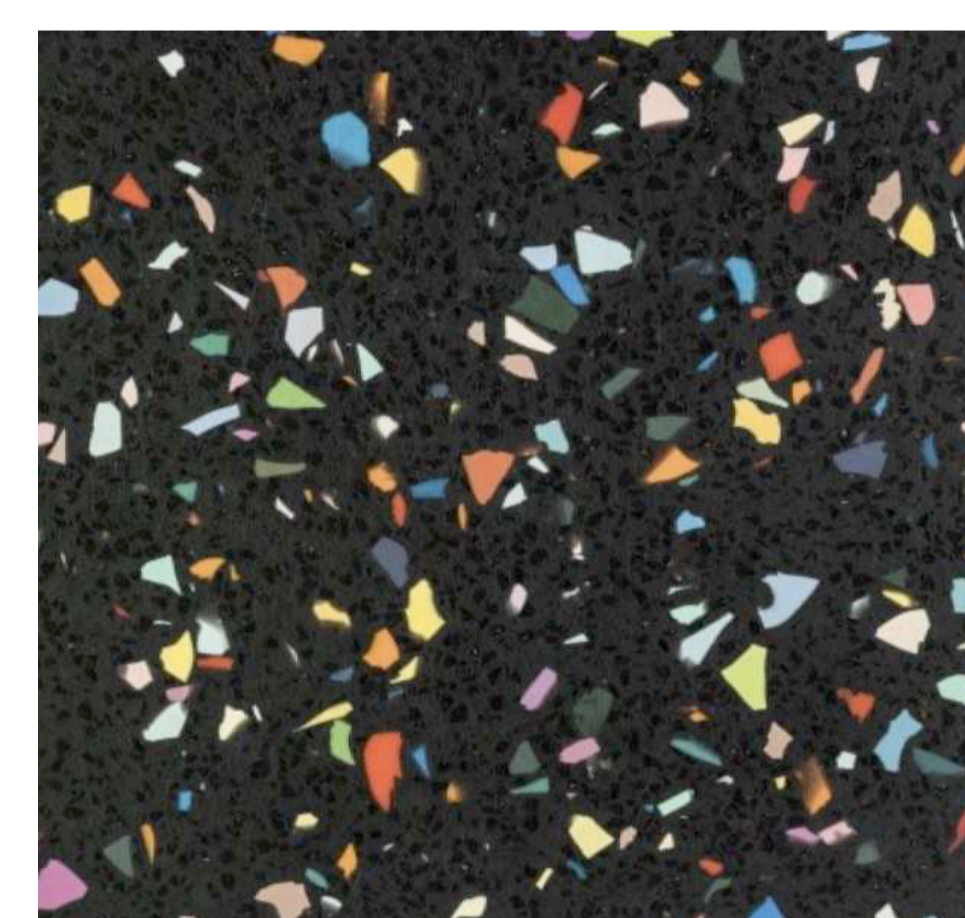

D0060 52 BLACK



D0700-08 BLACK



D0700-08 DARK BLUE

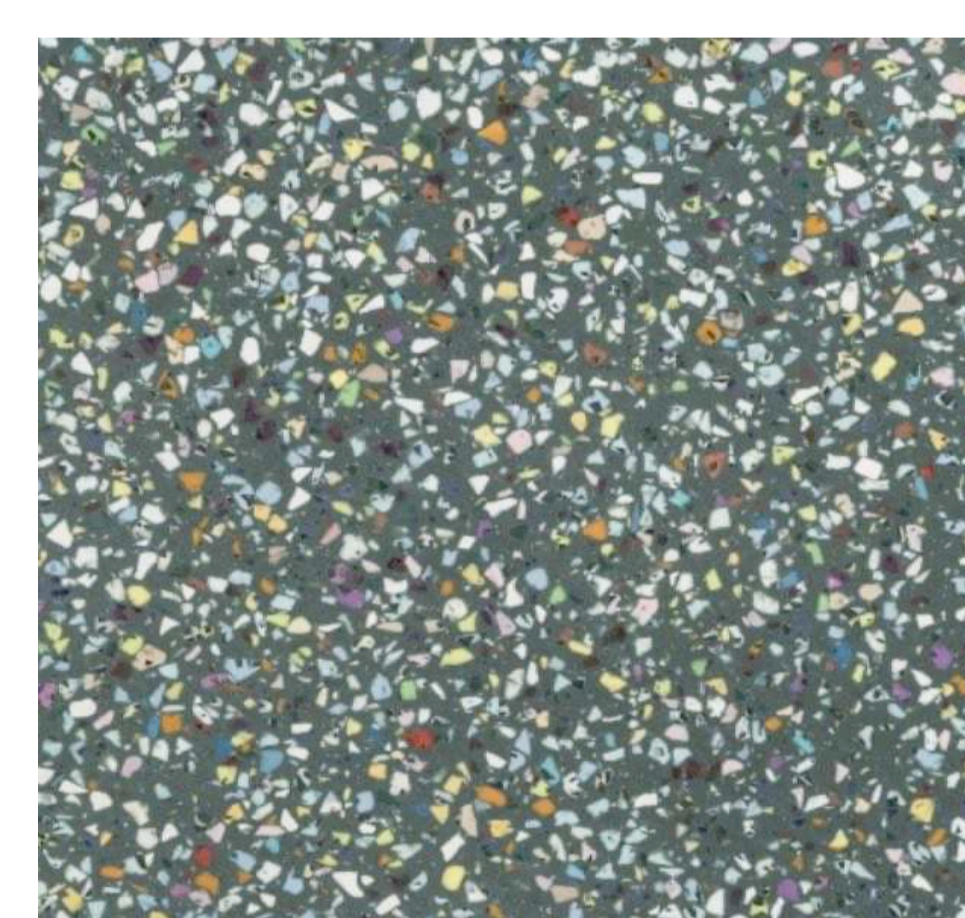

D0270 08 DARK GREEN



D0200 02 MEDIUM GREEN

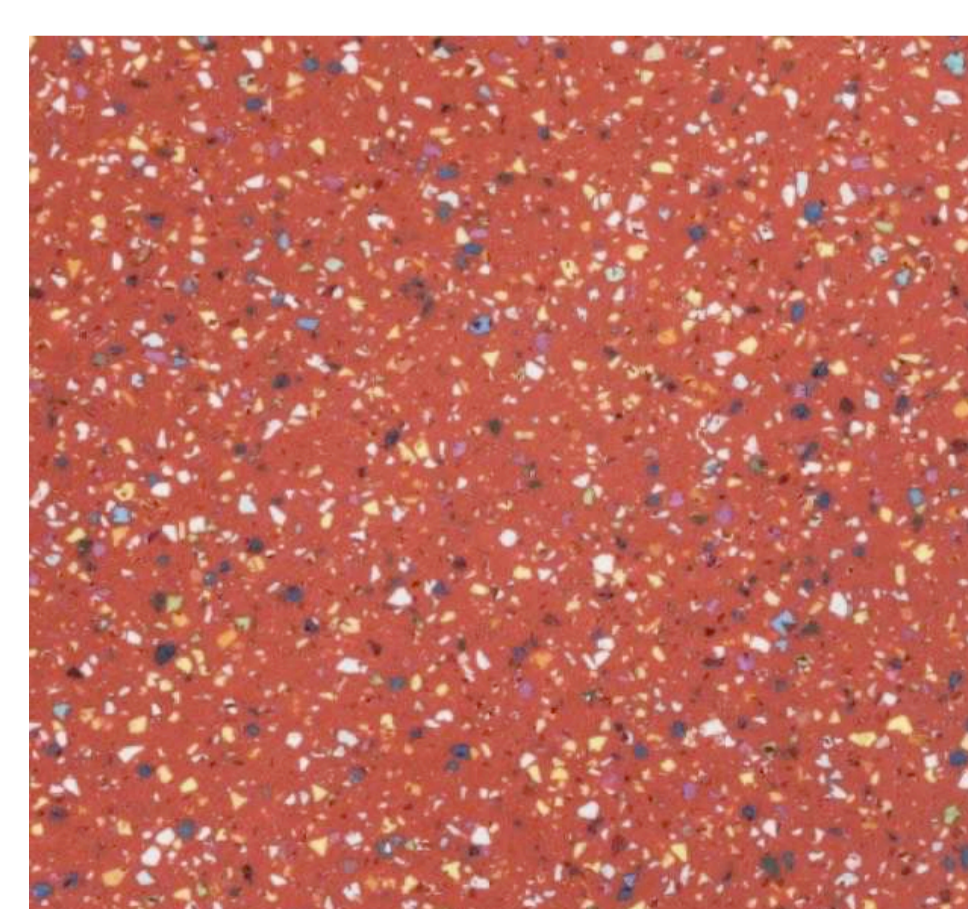

D00070 08 DEEP RED



D0030-08 GREY

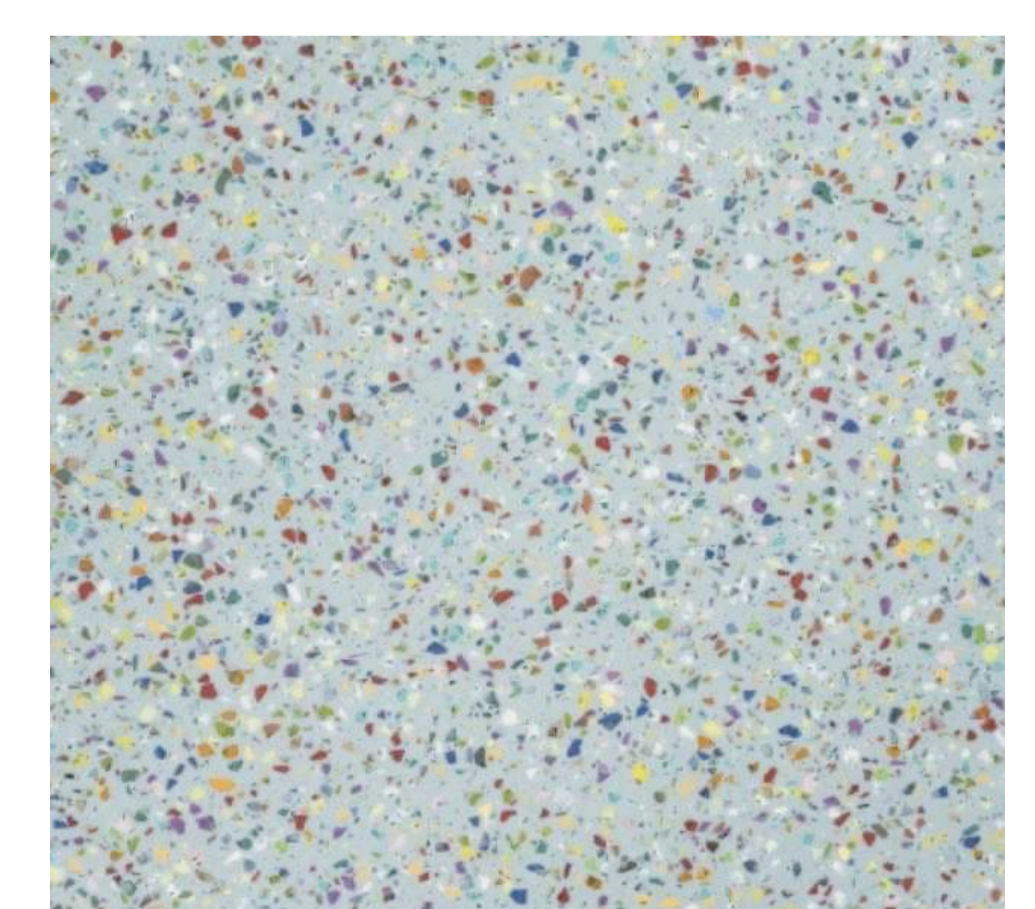

D0390 08 GREY BLUE

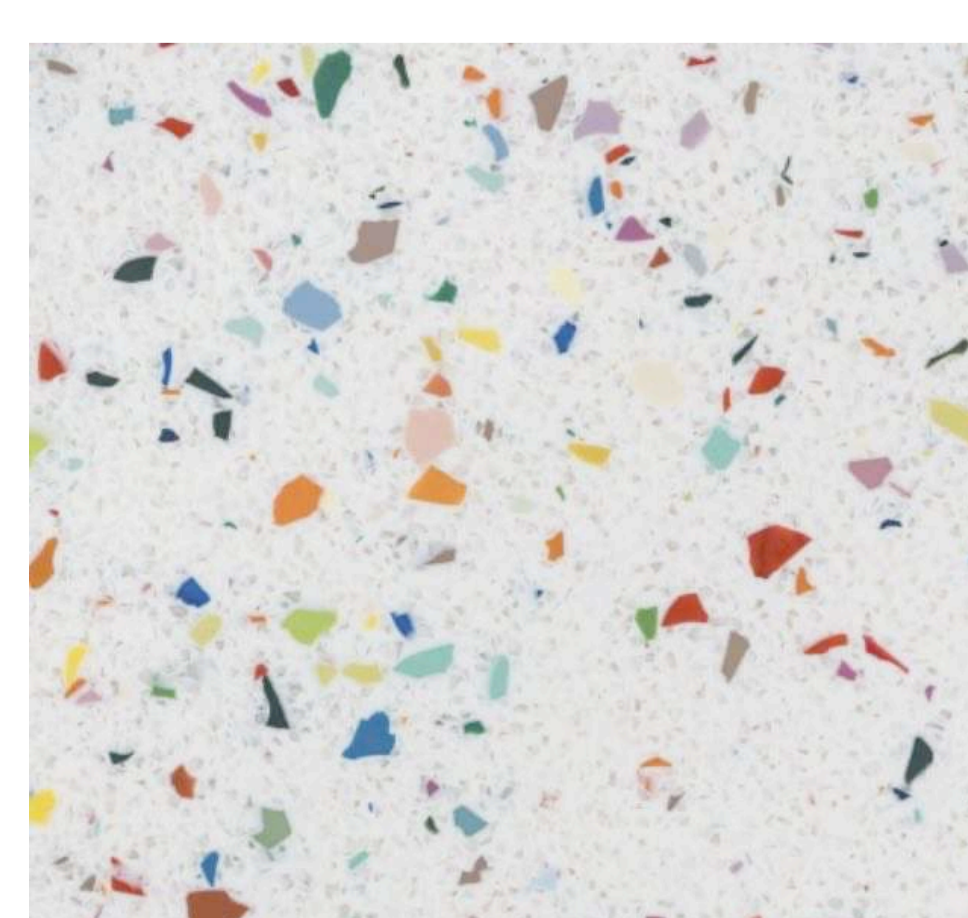

D0100 52 WHITE

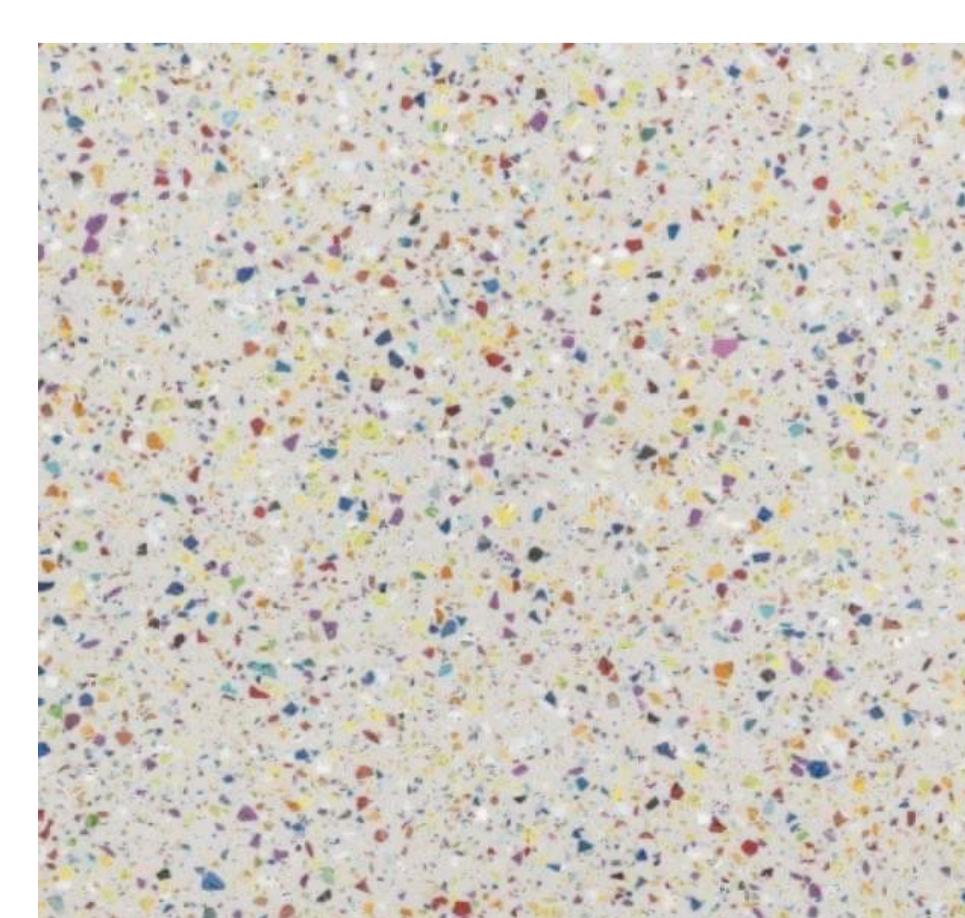

D0730 02 LIGHT GREY

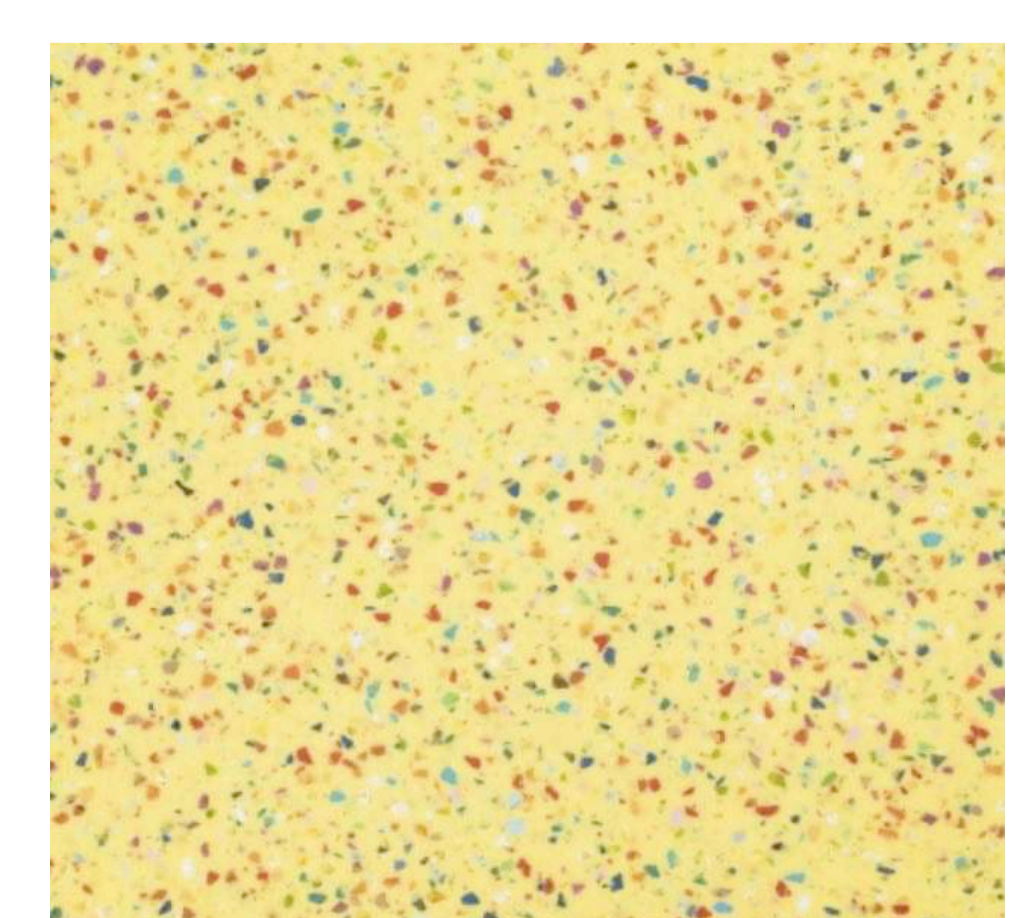

D0090 08 BRIGHT YELLOW



## CORIAN® 12MM

Corian® ist ein Mineralwerkstoff eine Mischung aus Mineralien und Acryl.

Technische Eigenschaften von Corian®:

- Corian® ist ein robustes und strapazierfähiges Material, das stoß- und schnittfest und gegen die meisten Beanspruchungen beständig ist.
- Oberflächen aus Corian® sind fugenlos, so dass sich dort keine Pilze oder Bakterien ansiedeln können.
- Corian® ist einfach zu reinigen, da Flecken nicht eindringen können, sondern auf der Oberfläche bleiben.
- Durch die Pflege mit einem normalen Reinigungsmittel oder einem Scheuermittel und einem Schwamm werden die Oberflächen aus Corian® wieder wie neu. Größere Schäden können repariert werden, indem Teile aus demselben Material nicht sichtbar eingesetzt werden.
- Corian® ist nicht hitzebeständig, man sollte keine heißen Töpfe ohne Untersetzer daraufstellen.

Corian® is a solid surface material made from a mixture of minerals and acrylic.

Technical properties of Corian®:

- Corian® is a tough and durable material that is impact and cut resistant and can withstand most wear and tear.
- Corian® surfaces are seamless, preventing the growth of fungi and bacteria.
- Corian® is easy to clean because stains do not penetrate but remain on the surface.
- Maintenance with a normal cleaning agent or a scouring agent and a sponge will make Corian® surfaces as good as new again. Major damage can be repaired by replacing parts made of the same material that are not visible.
- Corian® is heat-resistant up to 180 degrees Celsius.

## PFLEGE UND WARTUNG

Die Corian® Oberfläche kann mit einem weichen, mit warmem Wasser angefeuchteten Tuch

und einem milden Haushaltsreiniger gereinigt werden. Anschließend mit einem trockenen, weichen Tuch nachreiben.

Wir empfehlen unsere speziell auf die Oberflächen abgestimmten Pflegemittel.

## CARE AND MAINTENANCE

The Corian® surface can be cleaned with a soft cloth moistened with warm water and a mild household cleaner. Then wipe with a dry, soft cloth.

We recommend our care products specially formulated for the surfaces.



GLACIER WHITE

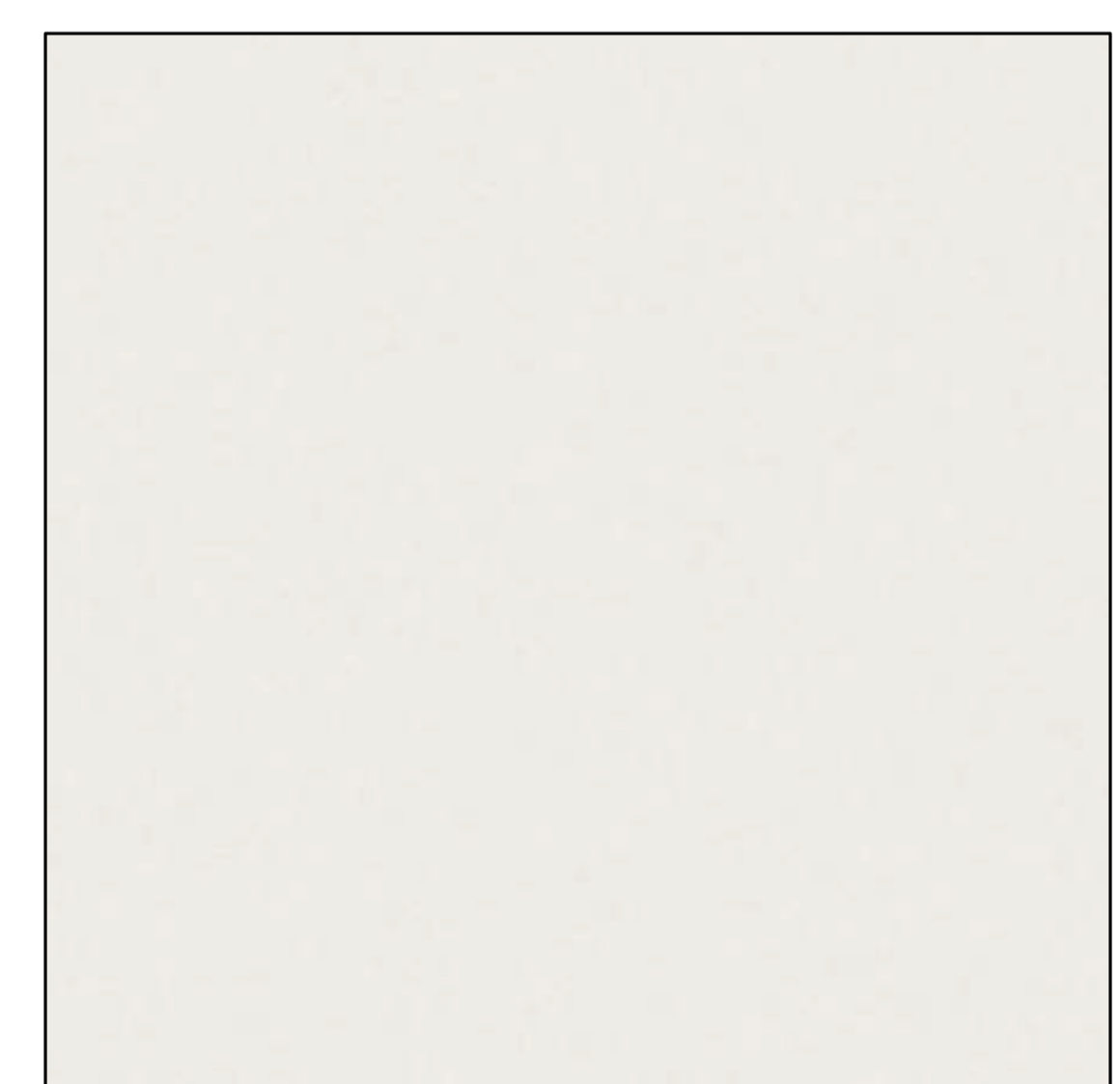

Cameo White

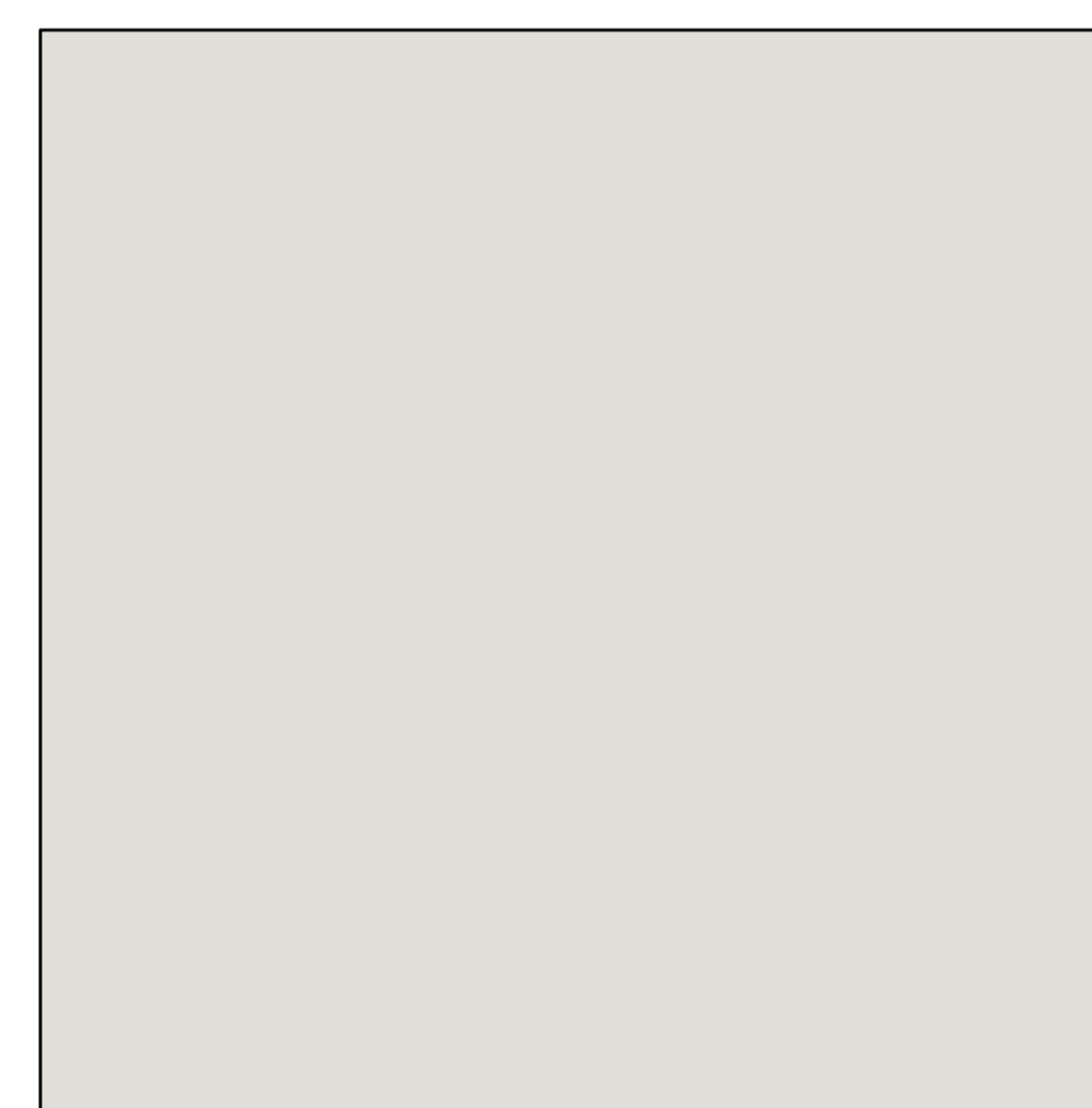

PEARL GRAY

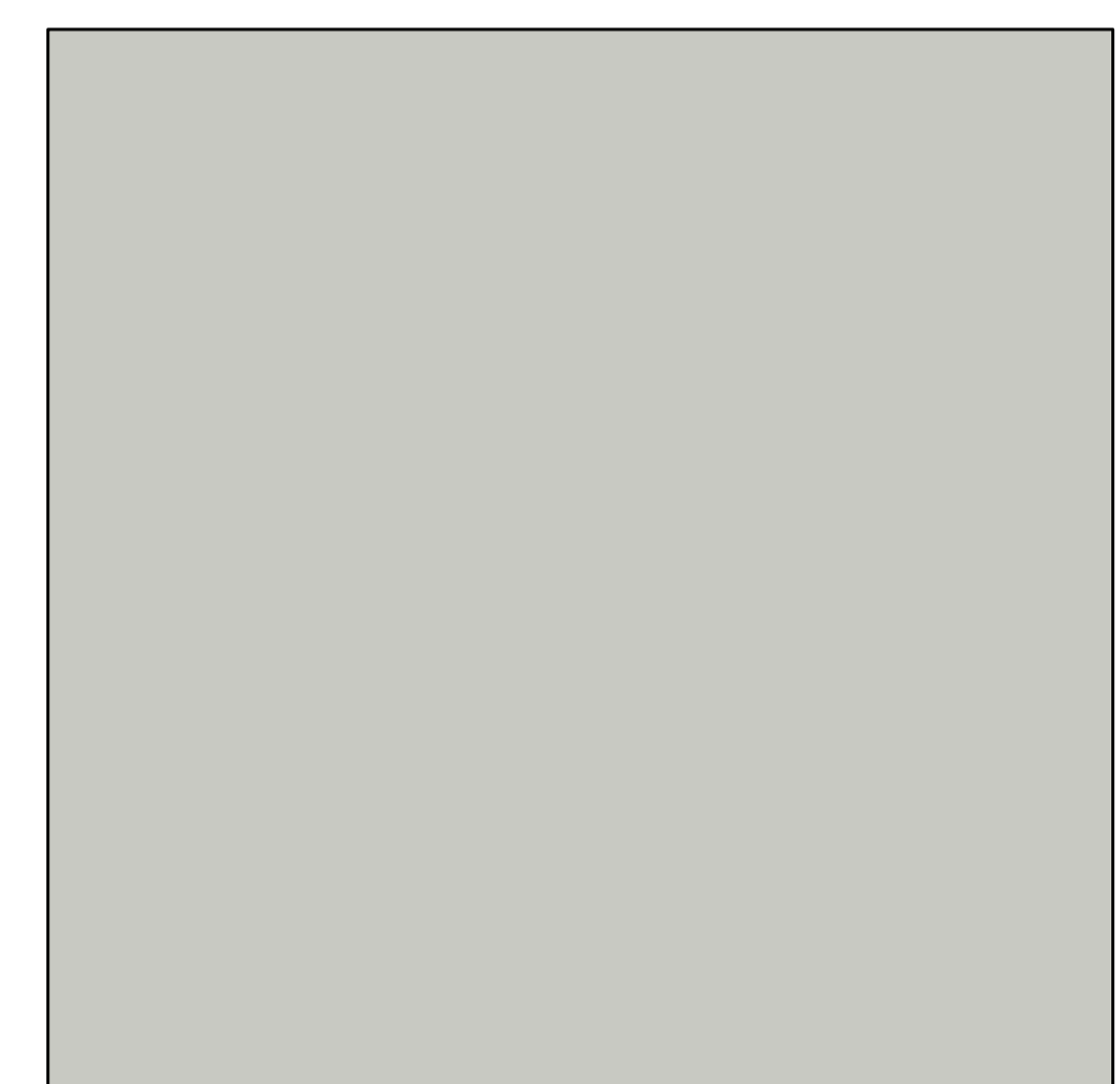

SILVER GRAY

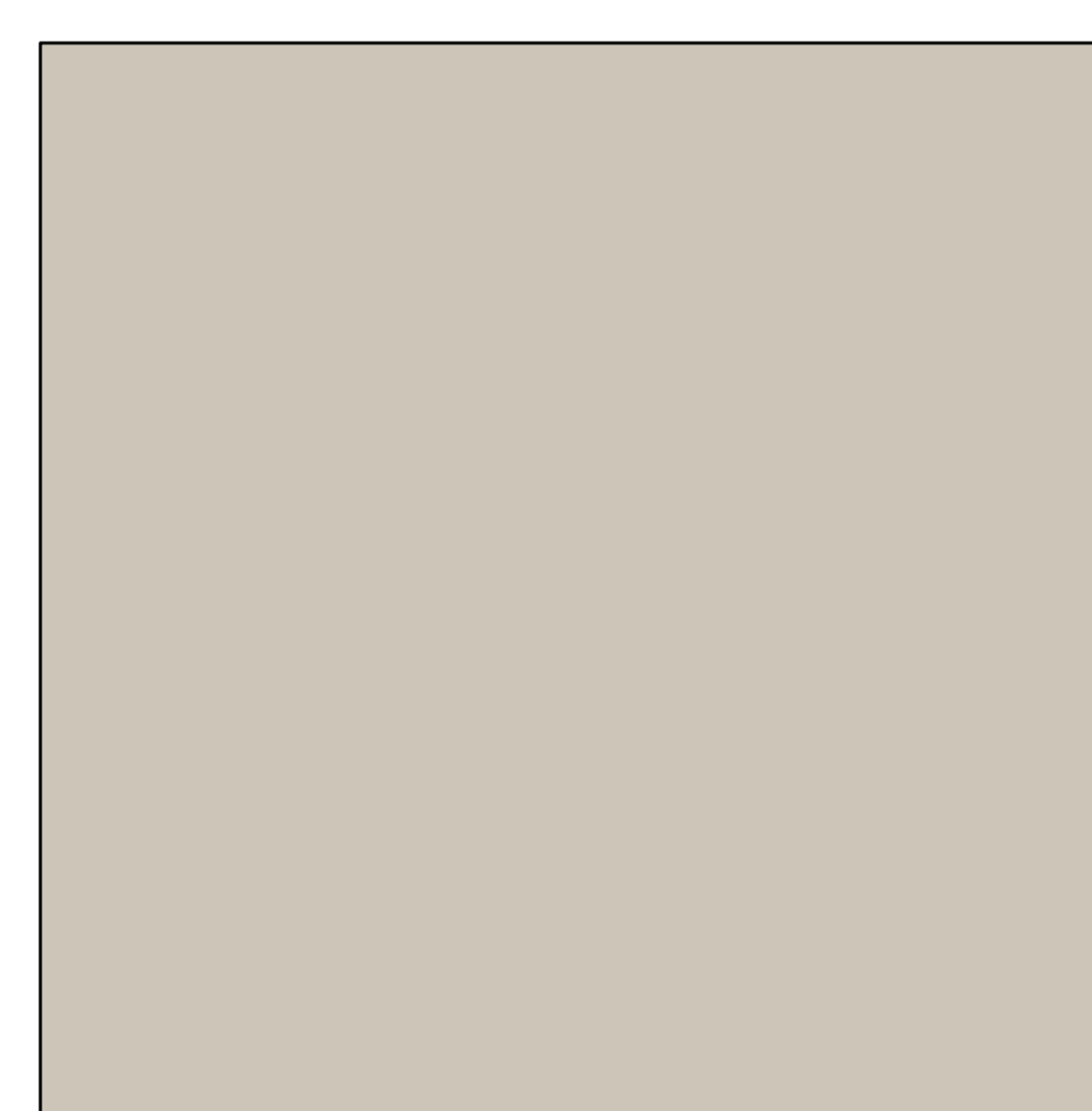

ELEGANT GRAY

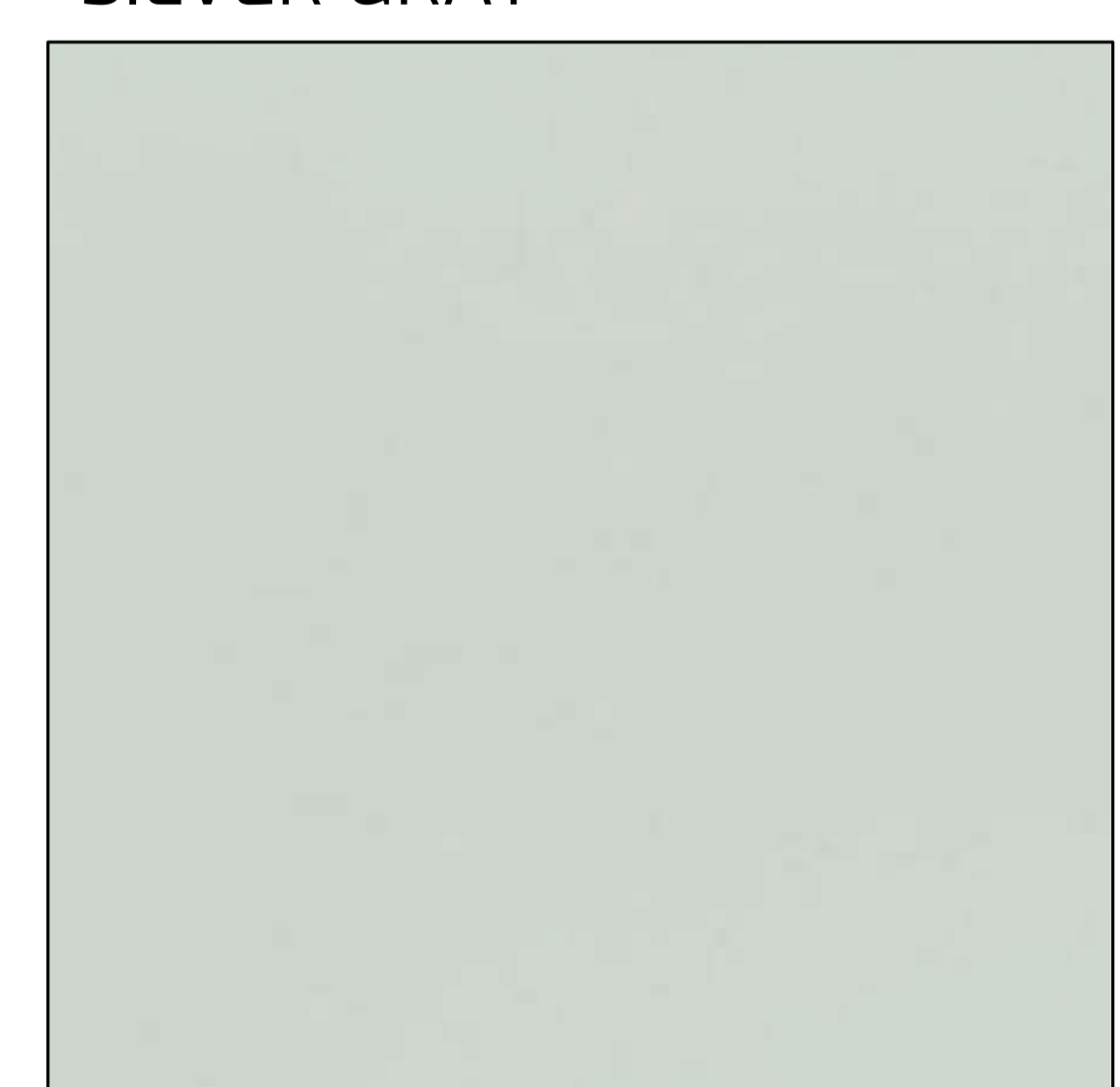

SEEGRASS



**WARMGEWALZTER EDELSTAHL 4MM UNBEHANDELT**

**HOT ROLLED STAINLESS STEEL 4MM UNTREATED**

## **PFLEGE UND WARTUNG**

Die Edelstahl Arbeitsplatte kann man mit einem weichen, in warmem Wasser angefeuchteten Tuch und einem milden Haushaltsreiniger gereinigt werden. Anschließend mit einem trockenen, weichen Tuch nachreiben.

Wir empfehlen unsere auf die Oberflächen abgestimmten Pflegemittel.

## **CARE AND MAINTENANCE**

The stainless steel worktop can be cleaned with a soft cloth dampened in warm water and a mild household cleaner. Then wipe with a dry, soft cloth.

We recommend using our surface care products.

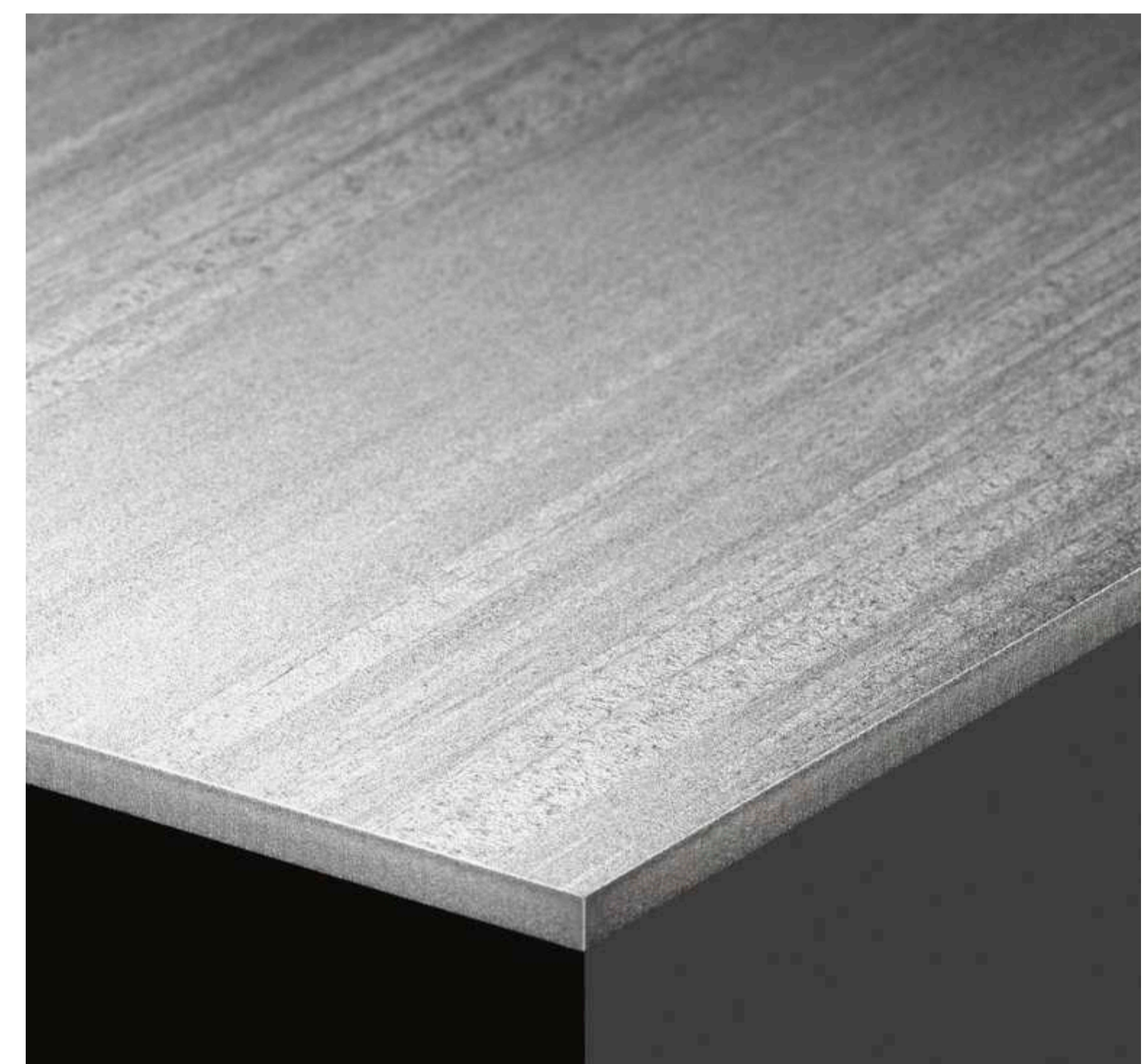



# DEVICES

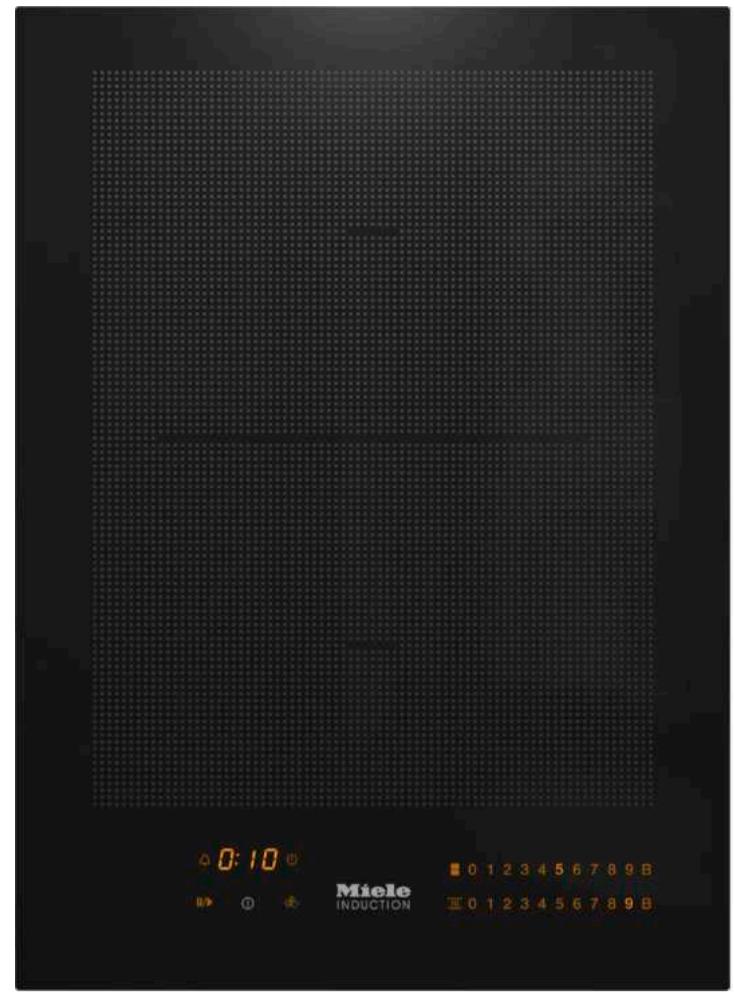

Kochfeld 23cm Breite  
Miele CS 7612 FL Schwarz  
Mit induktionsbeheiztem  
PowerFlex-Kochbereich

Hob 23cm width  
Miele CS 7612 FL Black  
With induction-heated  
PowerFlex cooking area



Dometic DM50NTE F  
Schubladen-Minibar  
Drawer minibar  
Praktischer Zugriff per  
Schublade, lautloser  
thermoelektrischer  
Betrieb, niedriger  
Energieverbrauch -

Dometic DM50NTE F  
Schubladen-Minibar  
Drawer minibar  
Practical drawer access,  
silent thermoelectric  
operation, low  
energy consumption -

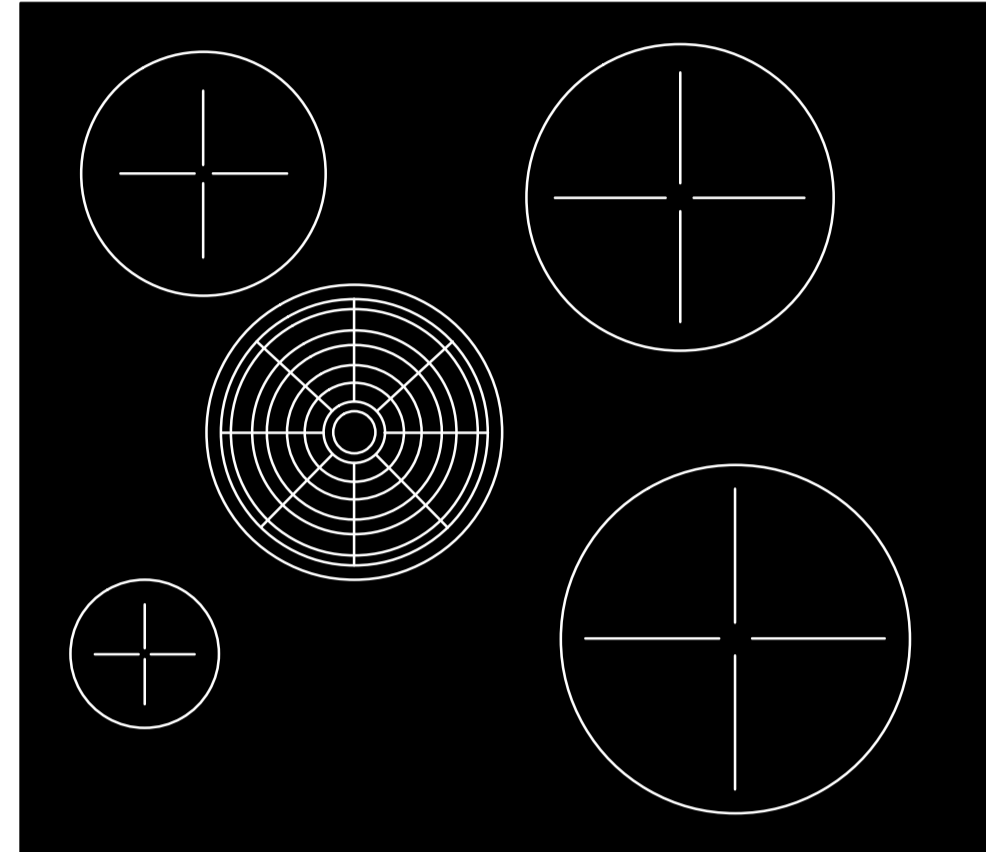

PURSU 5 Pure Induktions-  
Kochfeld mit integriertem  
Kochfeldabzug - Umluft

PURSU 5 Pure induction  
cooktop with integrated  
cooktop extractor -  
convection



Einbau-Kühlschrank 90cm

Built-in refrigerator 90cm

K 7127 D  
Mit DailyFresh, LED-  
Beleuchtung, SoftClose  
und SuperKühlen für mehr  
Komfort.

K 7127 D  
With DailyFresh, LED  
lighting, SoftClose and  
SuperCooling for more  
convenience.

K 7128 D  
Mit DailyFresh, 4\*-  
Gefrierfach, LED-  
Beleuchtung, und  
SoftClose für mehr  
Komfort.

K 7128 D  
With DailyFresh, 4\* freezer  
compartment, LED lighting  
and SoftClose for more  
convenience.



Kompakt-Backofen  
H 2841 B Edelstahl/  
CleanSteel

Compact oven  
H 2841 B Stainless steel/  
CleanSteel



Einbau-Kühlschrank 120cm

Built-in refrigerator 120cm

K 7327 D  
Mit DailyFresh, LED-  
Beleuchtung, SoftClose  
und SuperKühlen für mehr  
Komfort.

K 7327 D  
With DailyFresh, LED  
lighting, SoftClose and  
SuperCooling for more  
convenience.

Einbau-Kühlschrank  
K 7328 D  
Mit 4\*-Gefrierfach, LED  
Beleuchtung, SoftClose  
und SuperKühlen für mehr  
Komfort.

Built-in refrigerator  
K 7328 D  
With 4\* freezer  
compartment, LED  
lighting, SoftClose and  
SuperCool for more  
convenience.



Kompakt-Backofen  
H 7244 BP  
Obsidianschwarz

Compact oven  
H 7244 BP Obsidian black



Kompakt-Backofen mit  
Mikrowelle  
H 7440 BM  
Obsidianschwarz  
Im perfekt kombinierbaren  
Design mit  
Automatikprogrammen u.  
Kombi-Betriebsarten.

Compact oven with  
microwave  
H 7440 BM Obsidian black  
In a perfectly combinable  
design with automatic  
programs and combi  
operating modes.



Einbau-Kühlschrank 140cm

Built-in refrigerator 140cm

K 7443 D  
Mit PerfectFresh Pro für  
längere Frische, moderner  
LED-Beleuchtung und  
DynaCool.

K 7443 D  
With PerfectFresh Pro for  
longer freshness, modern  
LED lighting and DynaCool.

Einbau-Kühlschrank  
K 7444 D  
Mit PerfectFresh Pro für  
längere Frische, LED-  
Beleuchtung und 4\*-  
Gefrierfach.

Built-in refrigerator  
K 7444 D  
With PerfectFresh Pro for  
longer freshness, LED  
lighting and 4\* freezer  
compartment.

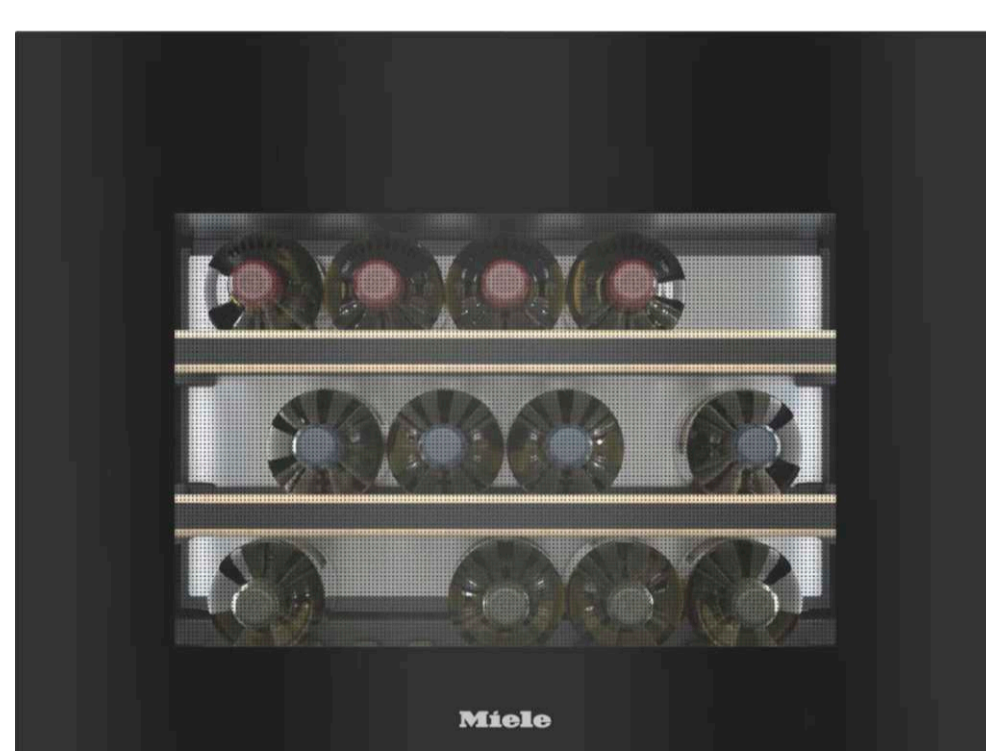

Einbau-  
Weintemperierschrank  
KWT 7112 iG  
Obsidianschwarz Glas  
Mit FlexiFrame Plus und  
Push2open für  
anspruchsvollste  
Weinliebhaber.

Built-in wine temperature  
control cabinet  
KWT 7112 iG Obsidian black  
glass  
With FlexiFrame Plus and  
Push2open for the most  
demanding wine lovers.

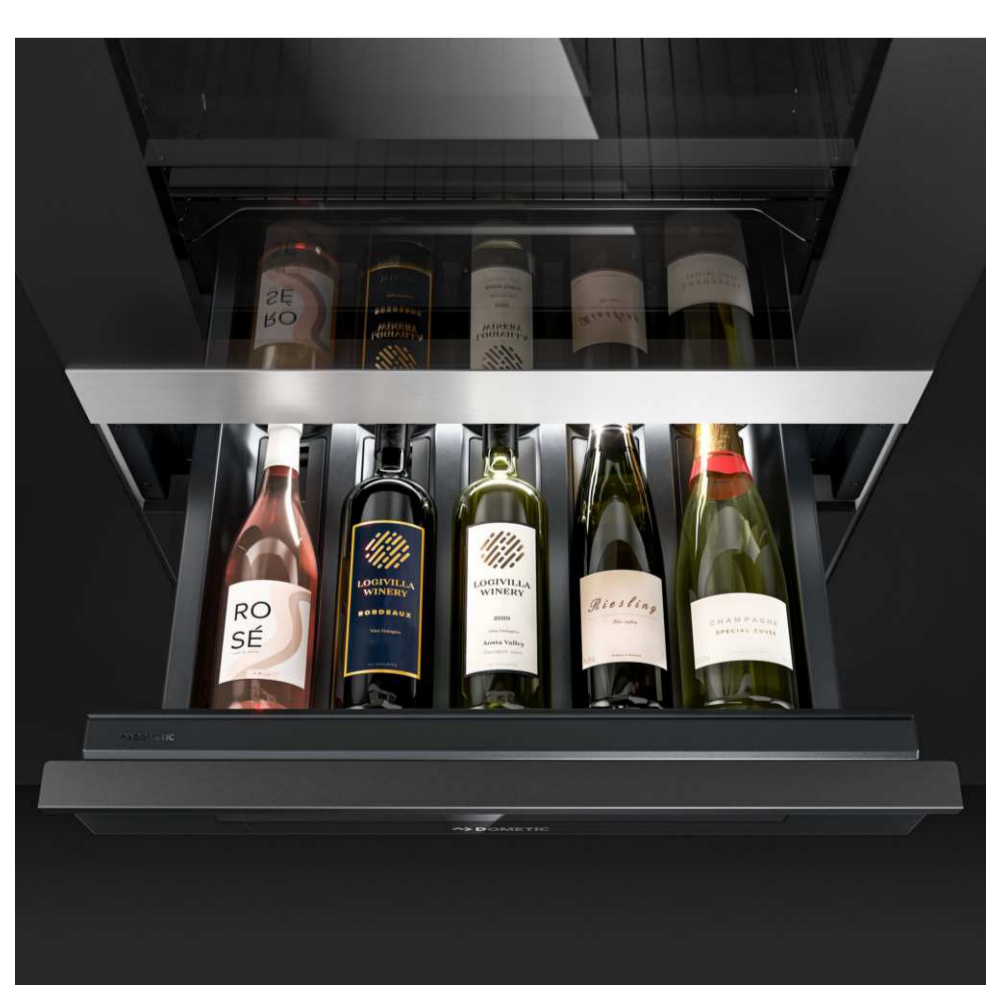

Dometic DrawBar 55  
Vollintegrierte  
Weinschublade Drawer  
Perfekte  
Serviertemperatur für  
jeden Wein (5, 8, 11, 14 oder  
17C)  
effiziente  
Kompressorkühltechnik  
Platz für 5 Flaschen

Dometic DrawBar 55  
Fully integrated wine  
drawer Drawer  
Perfect serving  
temperature for every  
wine (5, 8, 11, 14 or 17C)  
Efficient compressor  
cooling technology  
Space for 5 bottles



# DEVICES



Fisher & Paykel Schublade  
Spülmaschine DD60SHTI9  
integrierbar

Fisher & Paykel Dishwasher  
drawer DD60SHTI9  
integrable



**DRINK.HOT EVOL-S PRO**  
Die semiprofessionelle 4-  
in-1-Mischbatterie EVOL-S  
Pro drink.hot gibt Ihnen auf  
Knopfdruck eine exakte  
Menge 100°C gefiltertes  
oder perfekt gefiltertes  
kaltes Wasser.

**DRINK.HOT EVOL-S PRO**  
The semi-professional 4-  
in-1 mixer tap EVOL-S Pro  
drink.hot gives you an exact  
amount of 100°C filtered or  
perfectly filtered cold water  
at the touch of a button.



G 5790 SCVi SL Edelstahl  
CleanSteel

G 5790 SCVi SL stainless  
steel CleanSteel



**DRINK.SODA EVOL-S  
PRO**  
5-in-1 Semi-Profi-Armatur:  
Kaltes, warmes, sowie  
gekühltes, veredeltes  
Wasser still, medium und  
sprudelnd  
Still, medium, sprudelnd:  
Kohlensäuregehalt des  
gefilterten Wassers wählbar  
über separates Drehrad

**DRINK.SODA EVOL-S  
PRO**  
5-in-1 semi-professional  
tap: Cold, warm and chilled,  
refined water still, medium  
and sparkling  
Still, medium, sparkling:  
carbon dioxide content of  
the filtered water can be  
selected via a separate dial



**CATRIS-S FLEXO**  
Zweistrahlsbrause mit  
integriertem Durchfluss-  
Stopp: für leichtes  
Wechseln von Perlstrahl  
auf Brausestrahl  
Komfortable Arretierung  
der Brause durch präzise  
Magnethalterung

**CATRIS-S FLEXO**  
Dual-jet shower head with  
integrated flow stop: for  
easy switching from pearl  
jet to shower jet  
Convenient locking of the  
shower head with precise  
magnetic holder



**TALIA**  
Schock Armatur schwarz  
matt  
ausziehbarer Auslauf  
elegantes Design  
Anschlussschlauch  
600mm  
Schwenkradius 360Grad

**TALIA**  
Schock mixer tap black  
matt  
pull-out spout  
elegant design  
connection hose 600mm  
360 degree swivel radius



**BLANCO ANDANO**  
Edelstahlbecken mit der  
Breite 400 U Unterbau  
Hochwertige Ausstattung  
mit verdecktem Überlauf C-  
overflow und Ablaufsystem  
InFino – elegant integriert  
und besonders pflegeleicht

**BLANCO ANDANO**  
Stainless steel basin with  
400 U undermount width  
High-quality equipment with  
concealed overflow C-  
overflow and InFino drain  
system - elegantly  
integrated and particularly  
easy to clean



**BLANCO ANDANO**  
Edelstahlbecken mit der  
Breite 450U Unterbau  
Hochwertige Ausstattung  
mit verdecktem Überlauf C-  
overflow und Ablaufsystem  
InFino – elegant integriert  
und besonders pflegeleicht

**BLANCO ANDANO**  
Stainless steel basin with  
450U undermount width  
High-quality equipment with  
concealed overflow C-  
overflow and InFino drain  
system - elegantly  
integrated and particularly  
easy to clean



**BLANCO ANDANO**  
Edelstahlbecken mit der  
Breite 500 U Unterbau  
Hochwertige Ausstattung  
mit verdecktem Überlauf C-  
overflow und Ablaufsystem  
InFino – elegant integriert  
und besonders pflegeleicht

**BLANCO ANDANO**  
Stainless steel basin with  
500 U undermount width  
High-quality equipment with  
concealed overflow C-  
overflow and InFino drain  
system - elegantly  
integrated and particularly  
easy to clean

# Haftungsausschluss / Disclaimer

## Irrtümer und technische Änderungen vorbehalten.

Aufgrund fortwährender Verbesserungen durch Forschung und Entwicklung behält sich Neuvermoebelt das Recht vor, Produktspezifikationen oder Ausstattungsmerkmale ohne vorherige Ankündigungen zu ändern. Neuvermoebelt haftet nicht für Druckfehler. Die Veröffentlichung von Bildern und Grafiken bedarf der schriftlichen Zustimmung.

## Errors and technical modifications excepted.

Due to continuous improvements through research and development, Neuvermoebelt reserves the right to change product specifications or features without prior notice. Neuvermoebelt is not liable for printing errors. The publication of images and graphics requires written authorisation.

## IMPRESSUM

Gemäß § 5 E-Commerce-Gesetz (ECG):

Neuvermoebelt GmbH  
Handel und Manufaktur für Möbeldesign

FIRMENSITZ:  
1210 Wien, Sebastian-Kohl-Gasse 3-9/ Objekt 18

Kontakt:  
DI. Christian Bachmann  
M.A. Manuela Freigang

E-Mail:  
[welcome@neuvermoebelt.com](mailto:welcome@neuvermoebelt.com)

Internetadresse:  
[tinykitchen.neuvermoebelt.com](http://tinykitchen.neuvermoebelt.com)

Handelsgericht Wien  
FN 494541 t  
UID: ATU 73496317

Credits:  
Gesellschafter/Geschäftsführer/Designer:  
DI Christian Bachmann

Gesellschafter/Geschäftsführer/Designer:  
M.A. Manuela Freigang

Fotos:  
Neuvermoebelt®

Renderings:  
Markus Wintersteiger-Wilplinger

Texte:  
Neuvermoebelt®

Grafik:  
Neuvermoebelt®,  
Markus Wintersteiger-Wilplinger

## IMPRINT

According to § 5 E-Commerce Law (ECG):

Neuvermoebelt GmbH  
Trade and production for furniture design

HEADQUARTERS:  
1210 Vienna, Sebastian-Kohl-Gasse 3-9/ Objekt 18

Contact person  
DI. Christian Bachmann  
M.A. Manuela Freigang

E-Mail:  
[welcome@neuvermoebelt.com](mailto:welcome@neuvermoebelt.com)

Web Address:  
[tinykitchen.neuvermoebelt.com](http://tinykitchen.neuvermoebelt.com)

Commercial Court Vienna  
FN 494541 t  
UID: ATU 73496317

Credits:  
Shareholder/Managing Director/Creator:  
DI Christian Bachmann

Shareholder/Managing Director/Creator:  
M.A. Manuela Freigang

Photos:  
Neuvermoebelt®

Renderings:  
Markus Wintersteiger-Wilplinger

Texts:  
Neuvermoebelt

Graphics:  
Neuvermoebelt®,  
Markus Wintersteiger-Wilplinger

