

DATA SHEET

TINY KITCHEN »HOME«



OVERVIEW _ UNITS

Legende:  Kochfeld mit Abzug,  Geschirrspüler,  Mülltrennsystem,  Kühlschrank,  Backofen,  Weinkühlchrank,

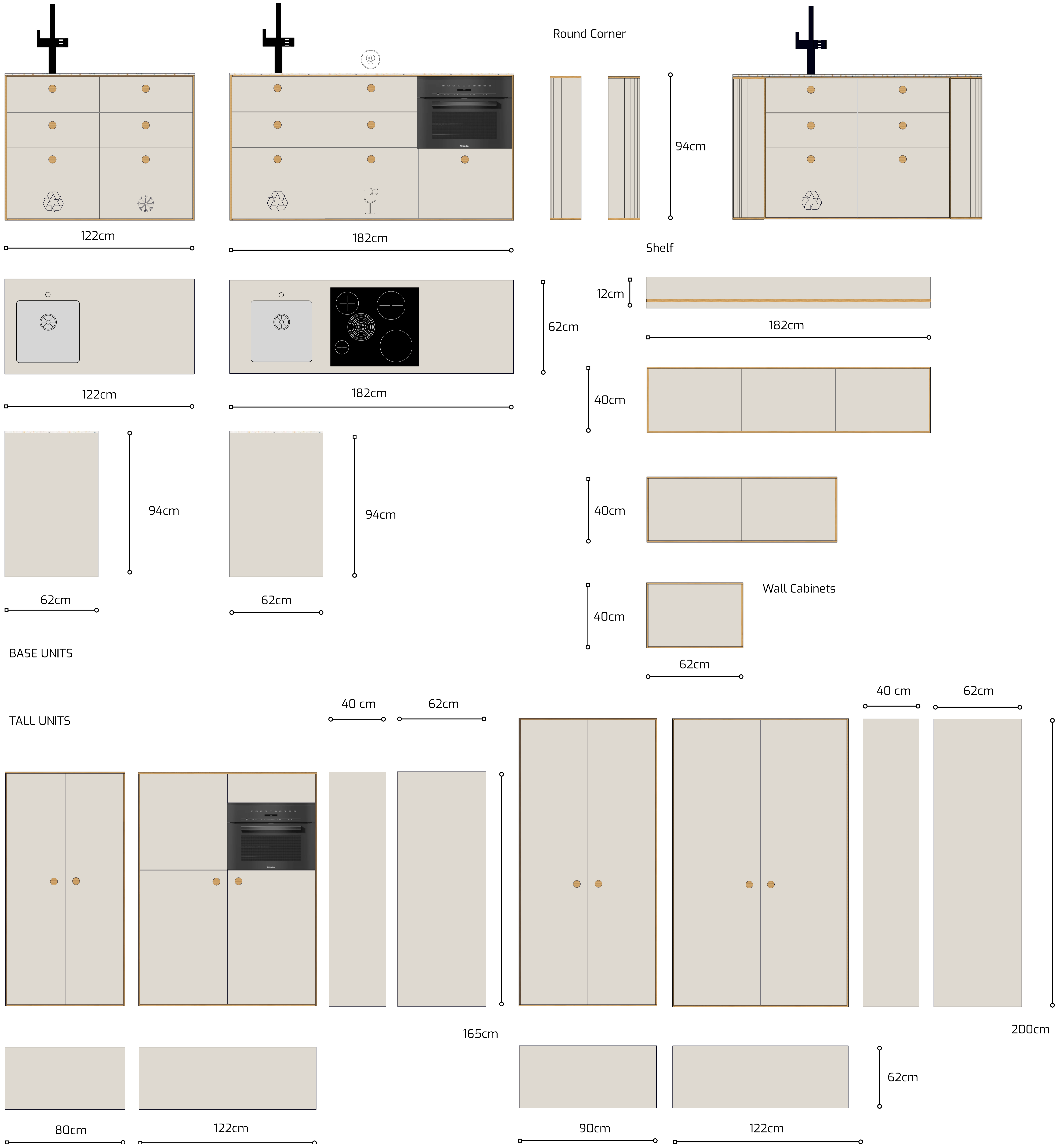

BASE UNITS 120 cm

TINY KITCHEN «OFFICE»2024 **neuvermoebelt®**

Legende:  Kochfeld mit Abzug,  Geschirrspüler,  Mülltrennsystem,  Kühlschrank,  Backofen,  Weinkühlchrank,

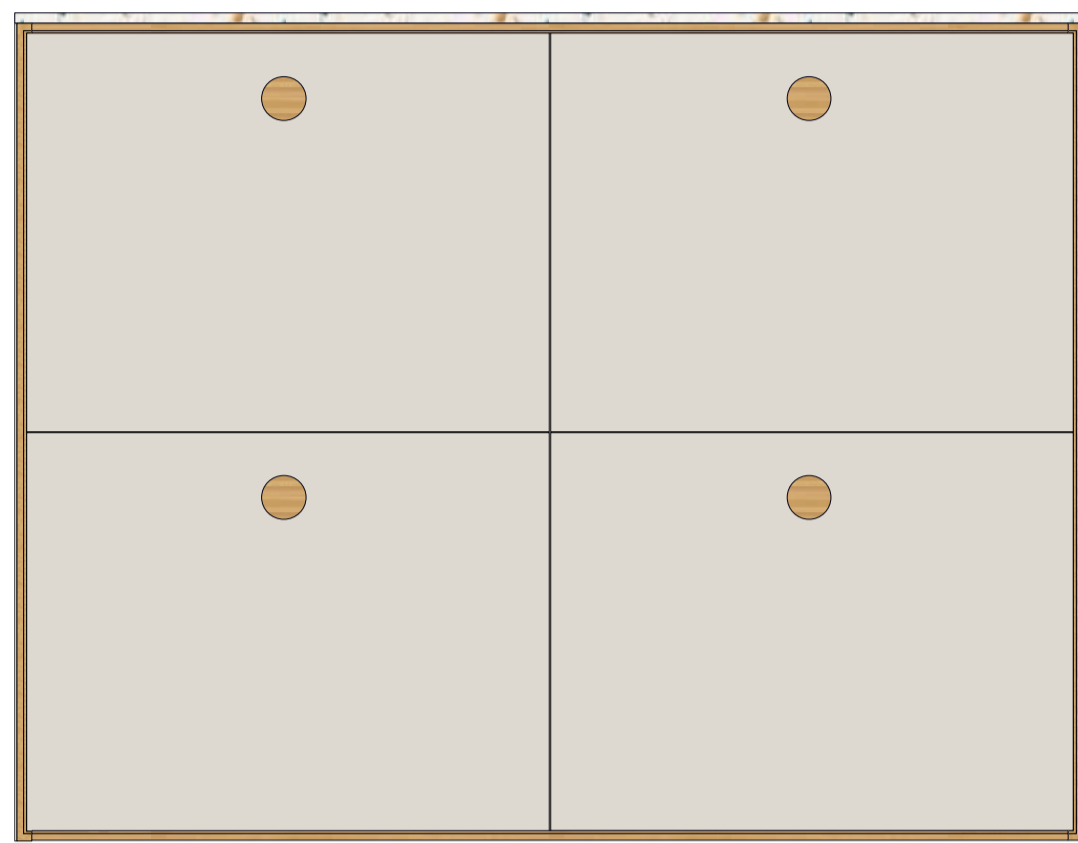

Base Unit 001

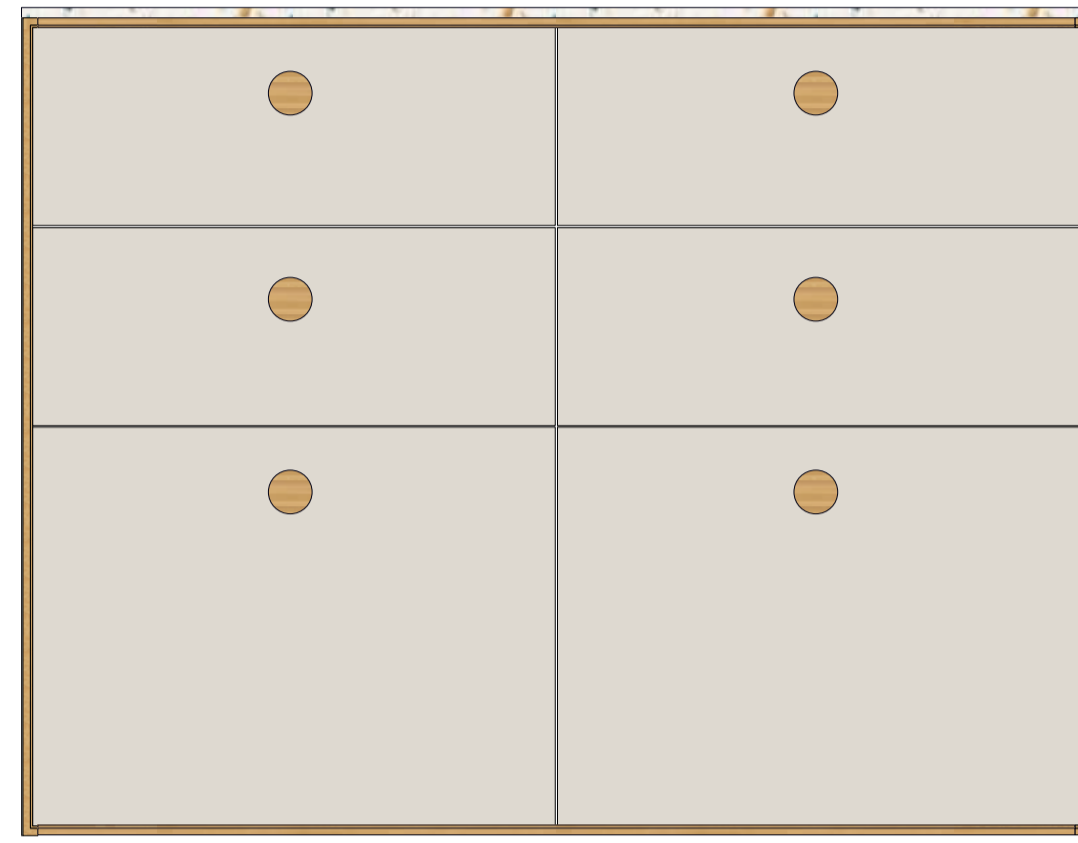
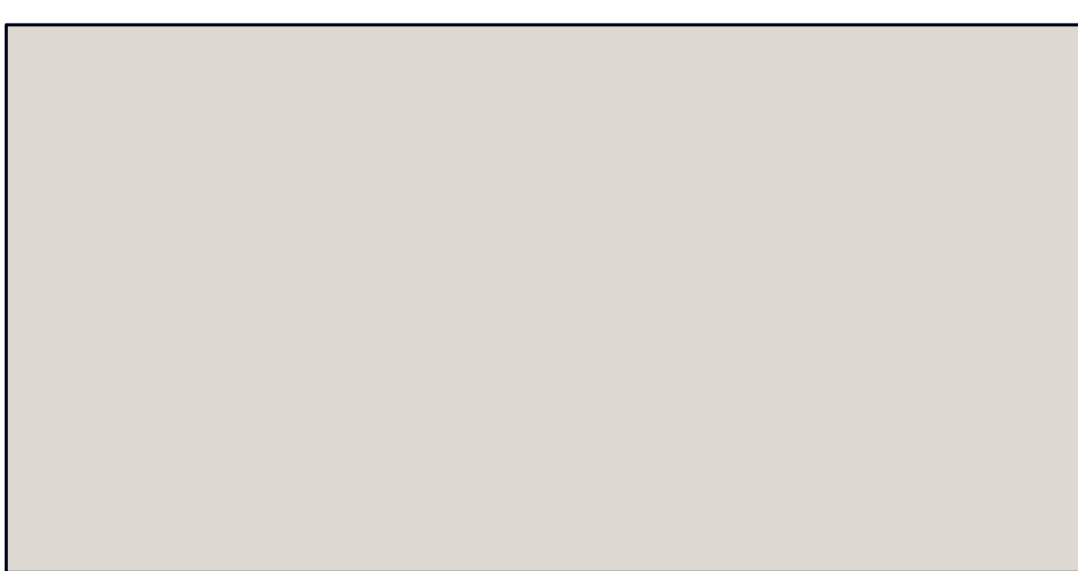

Base Unit 002

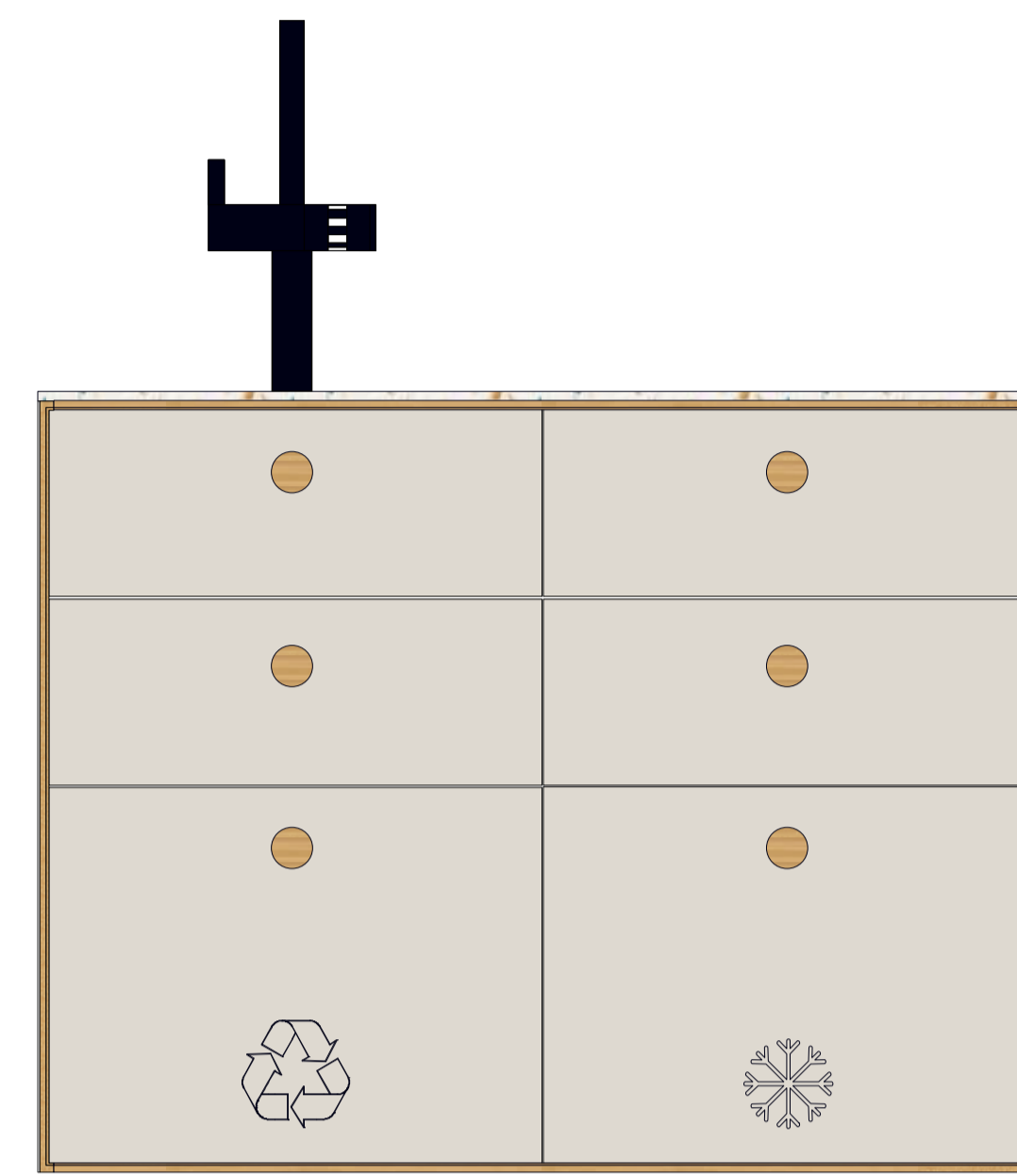
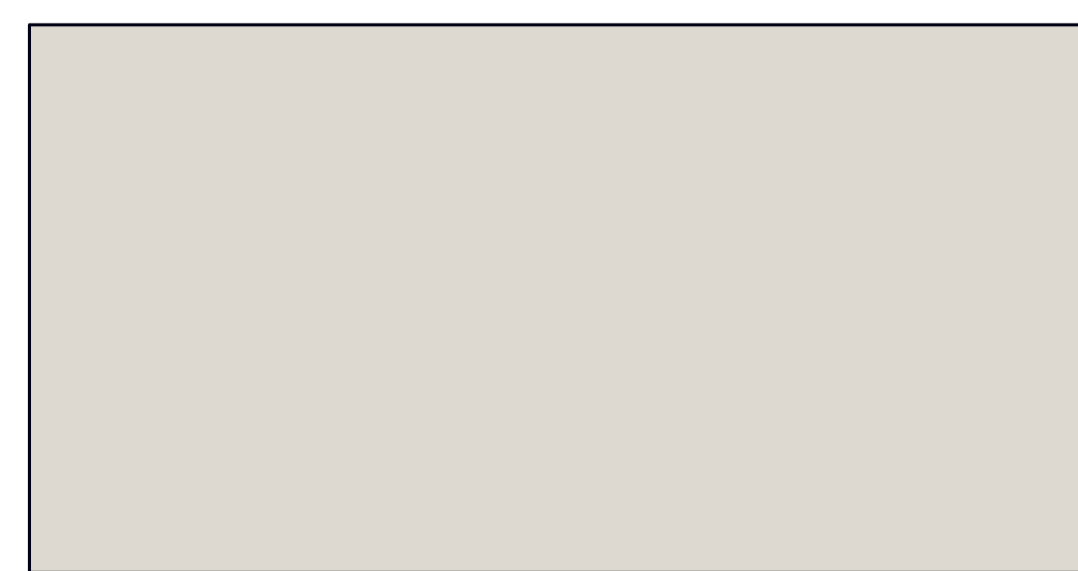

Base Unit 003

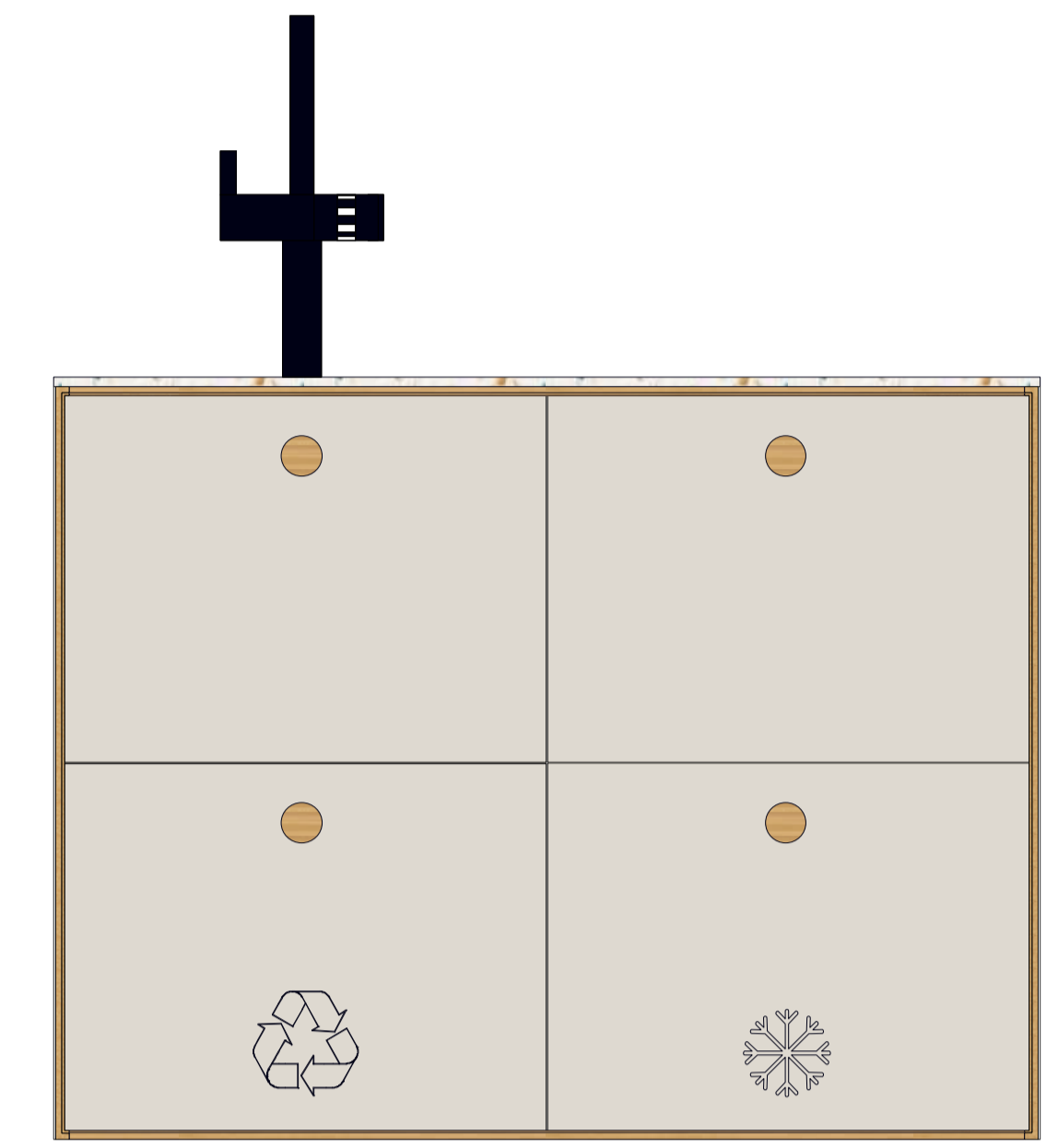
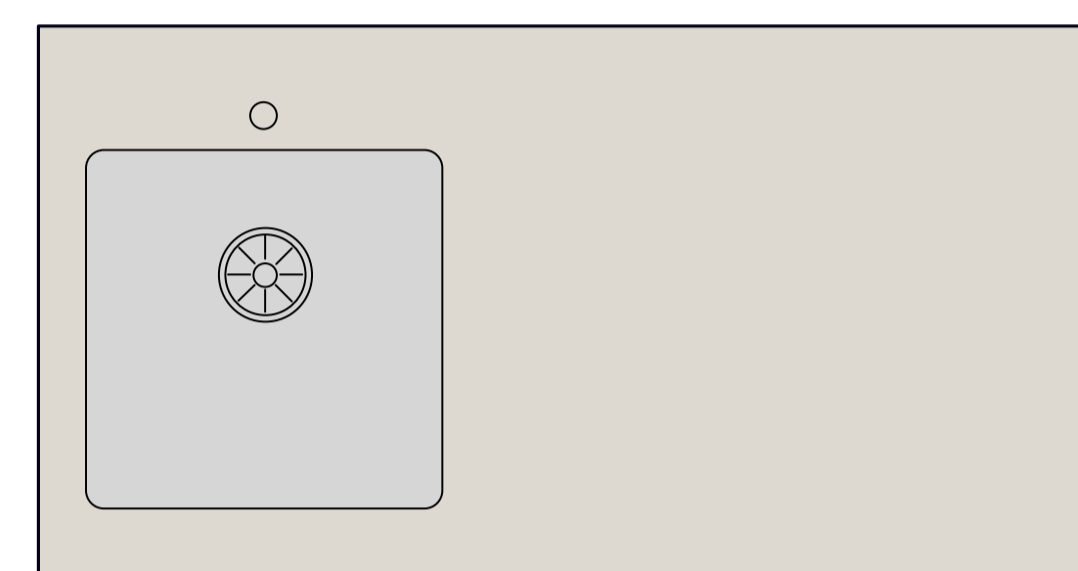

Base Unit 003

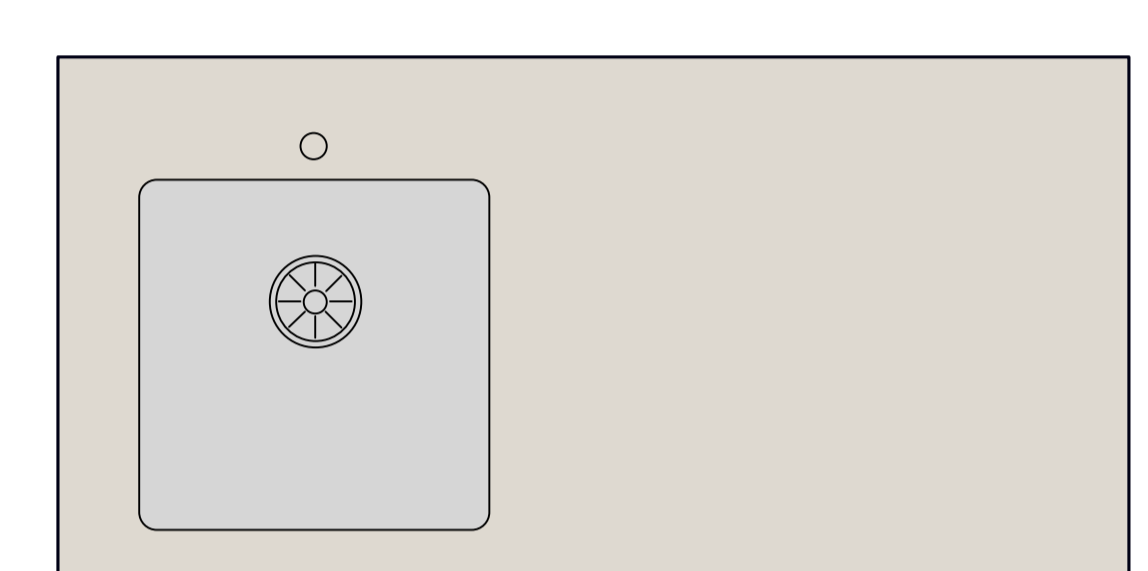

Base Unit 004

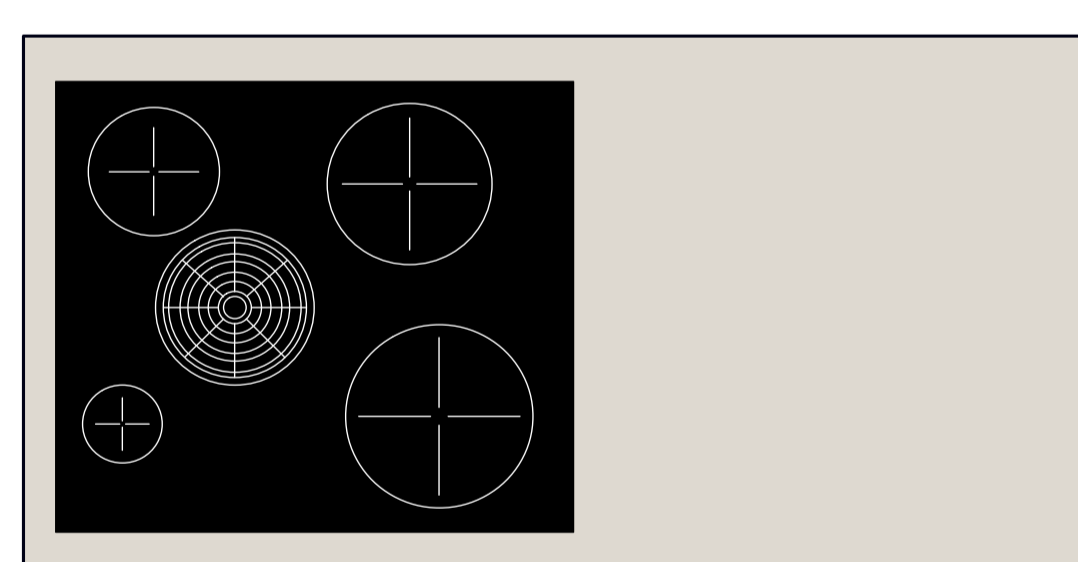

Base Unit 005

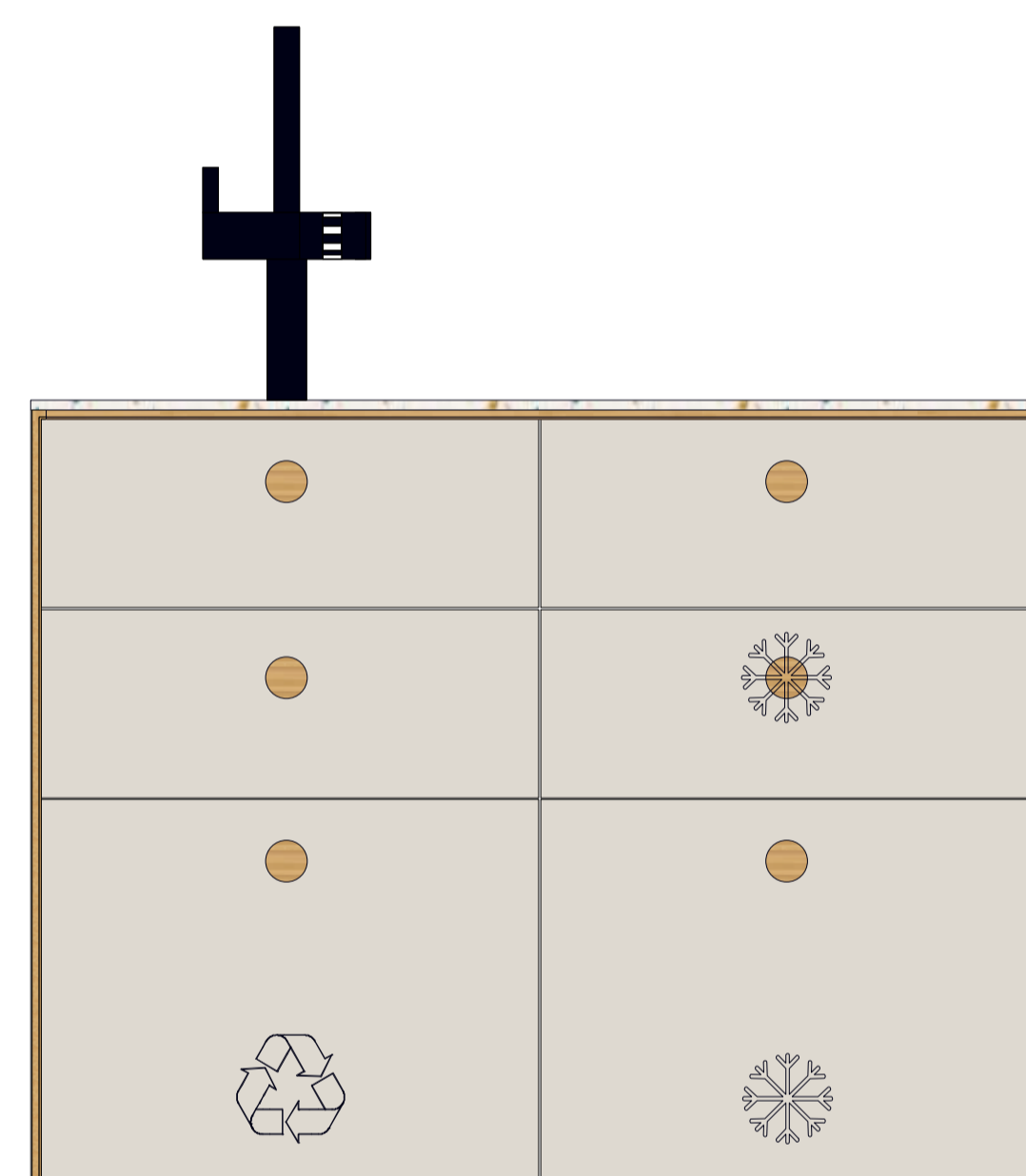
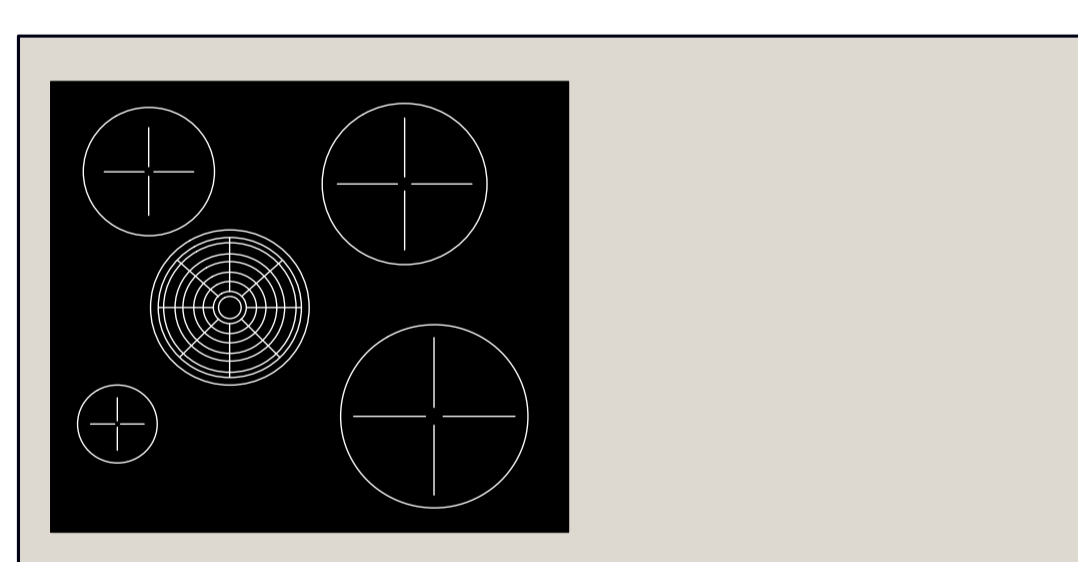

Base Unit 006

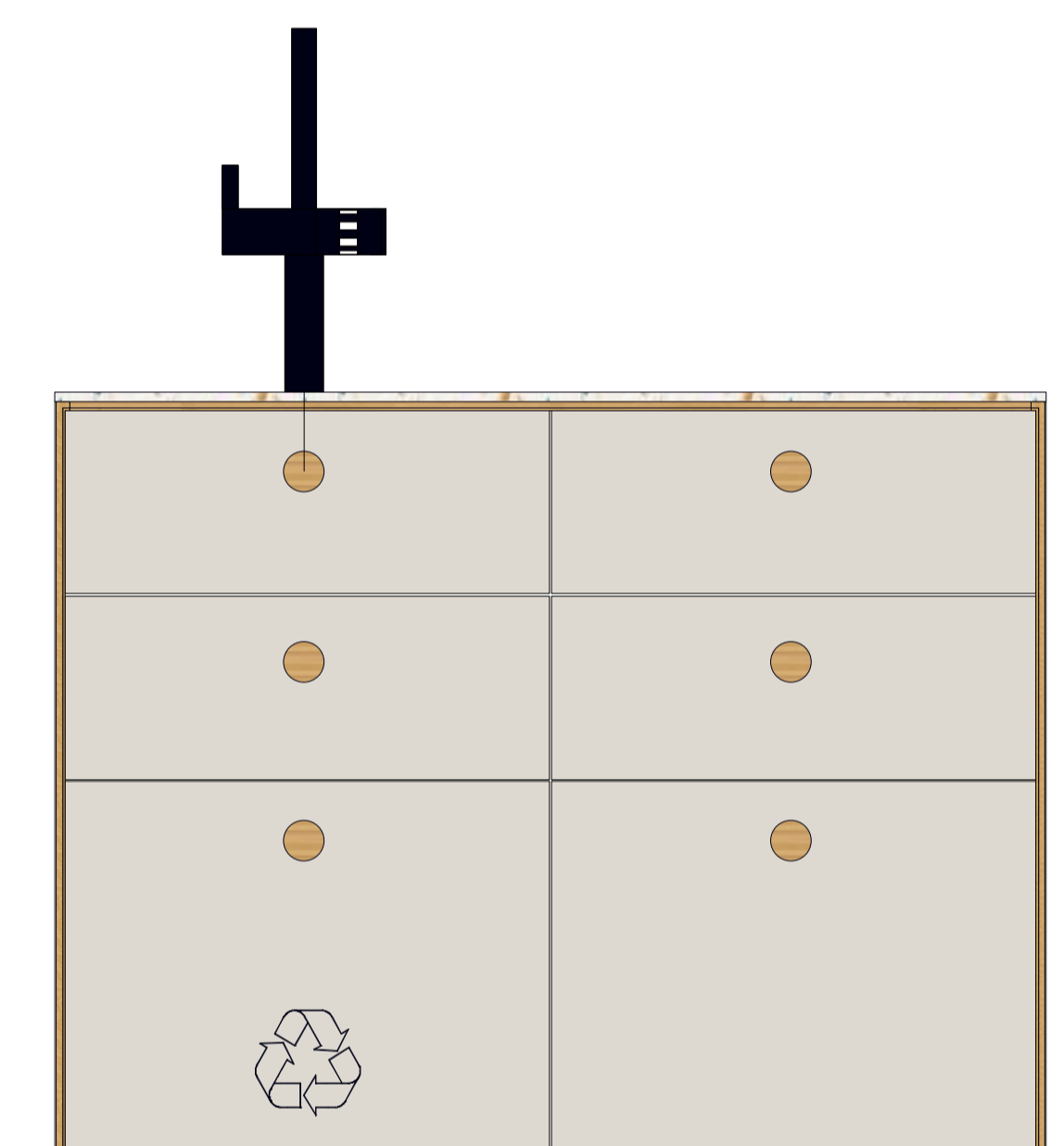
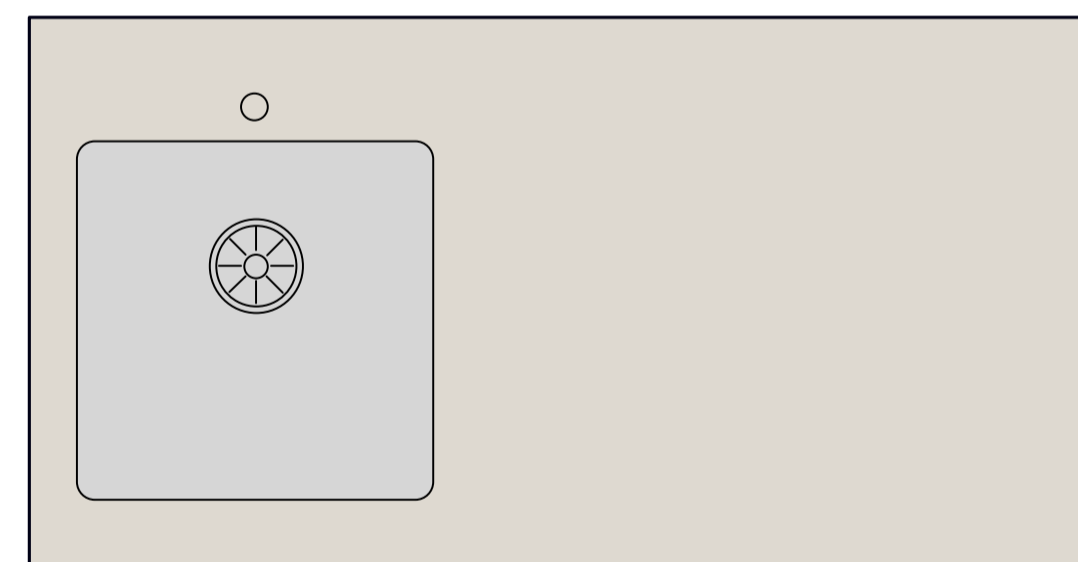

Base Unit 007

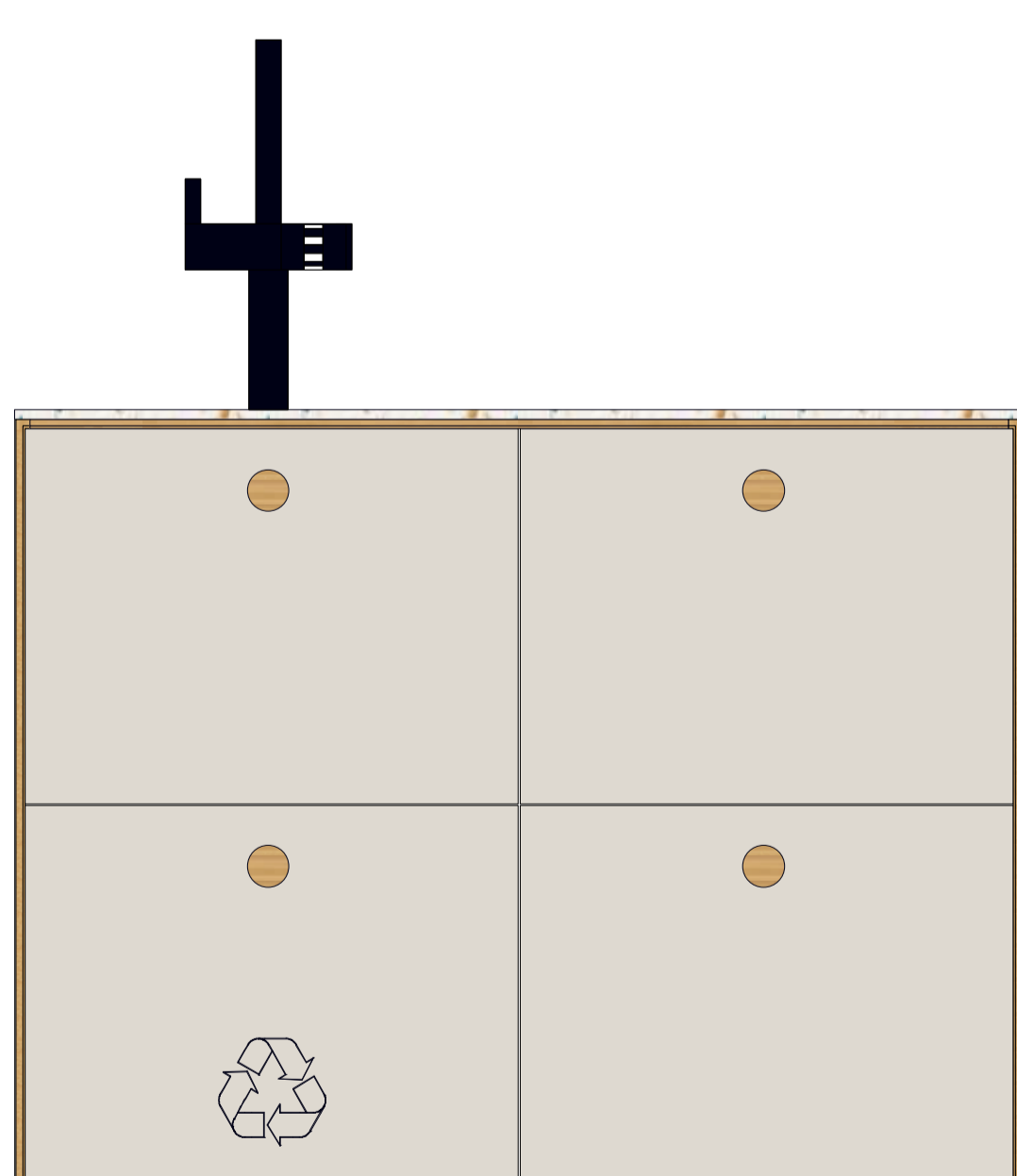
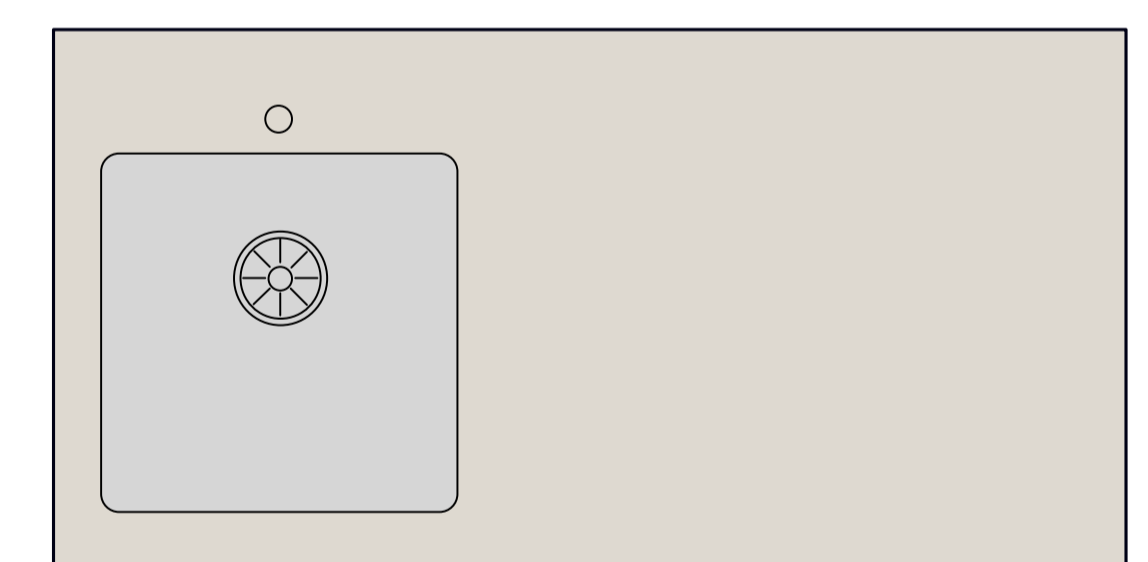

Base Unit 008

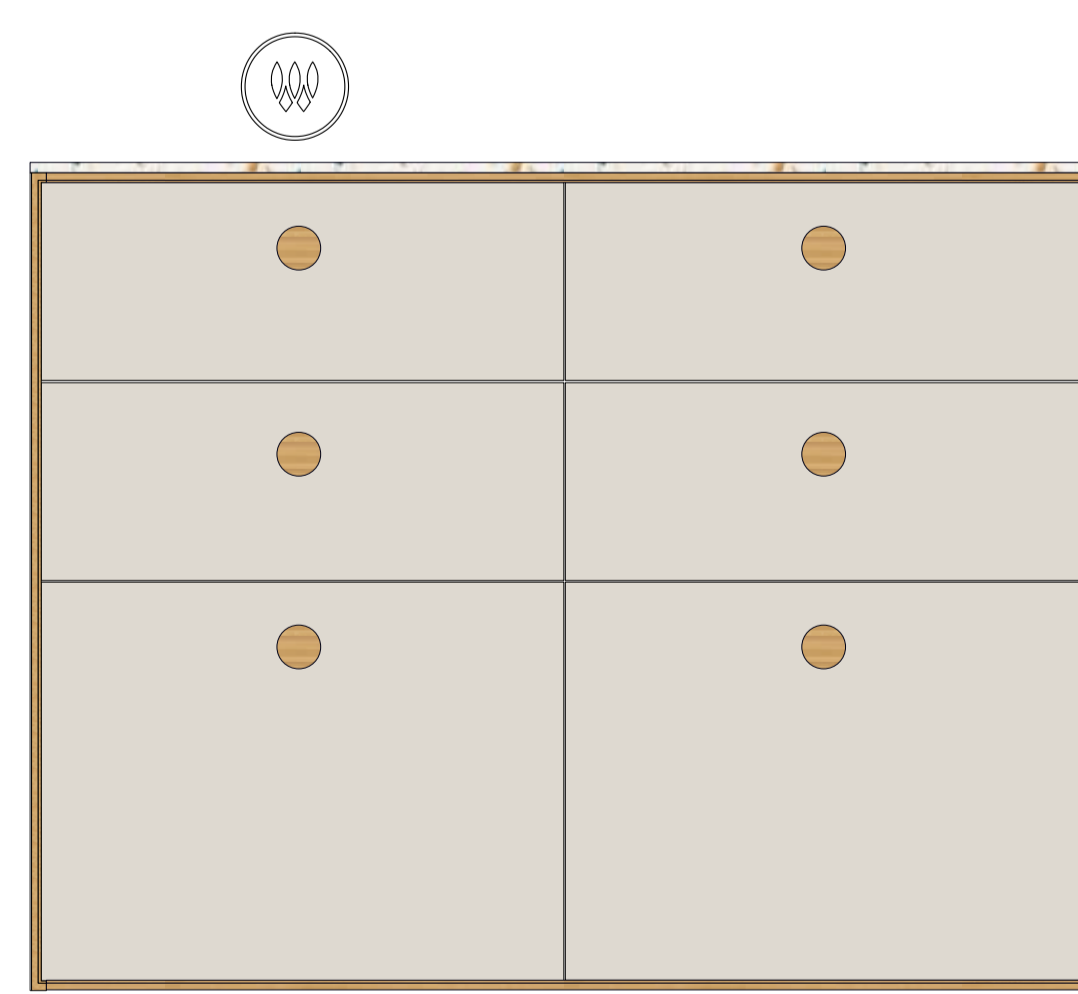
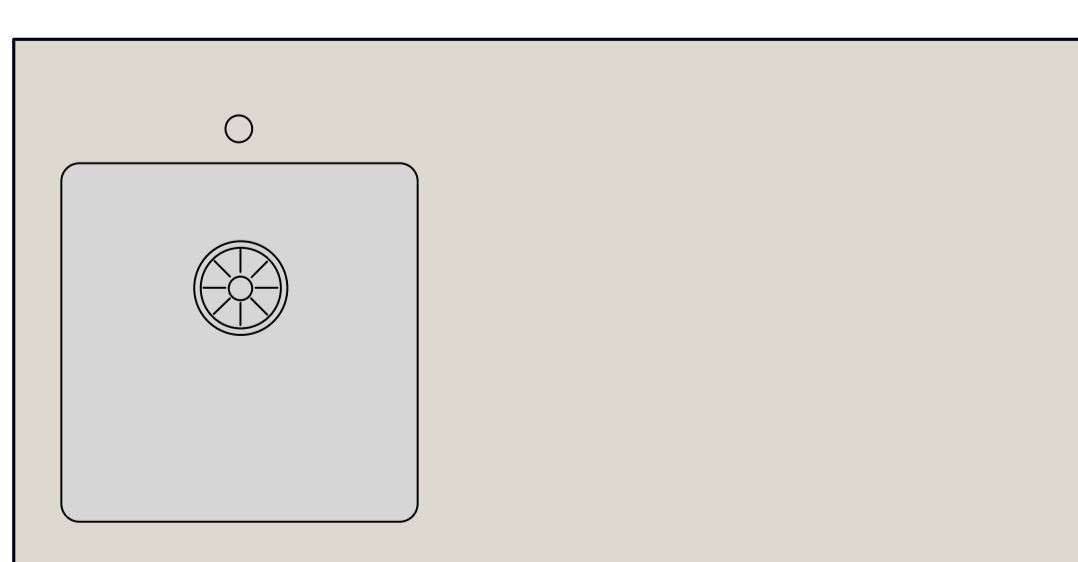

Base Unit 009

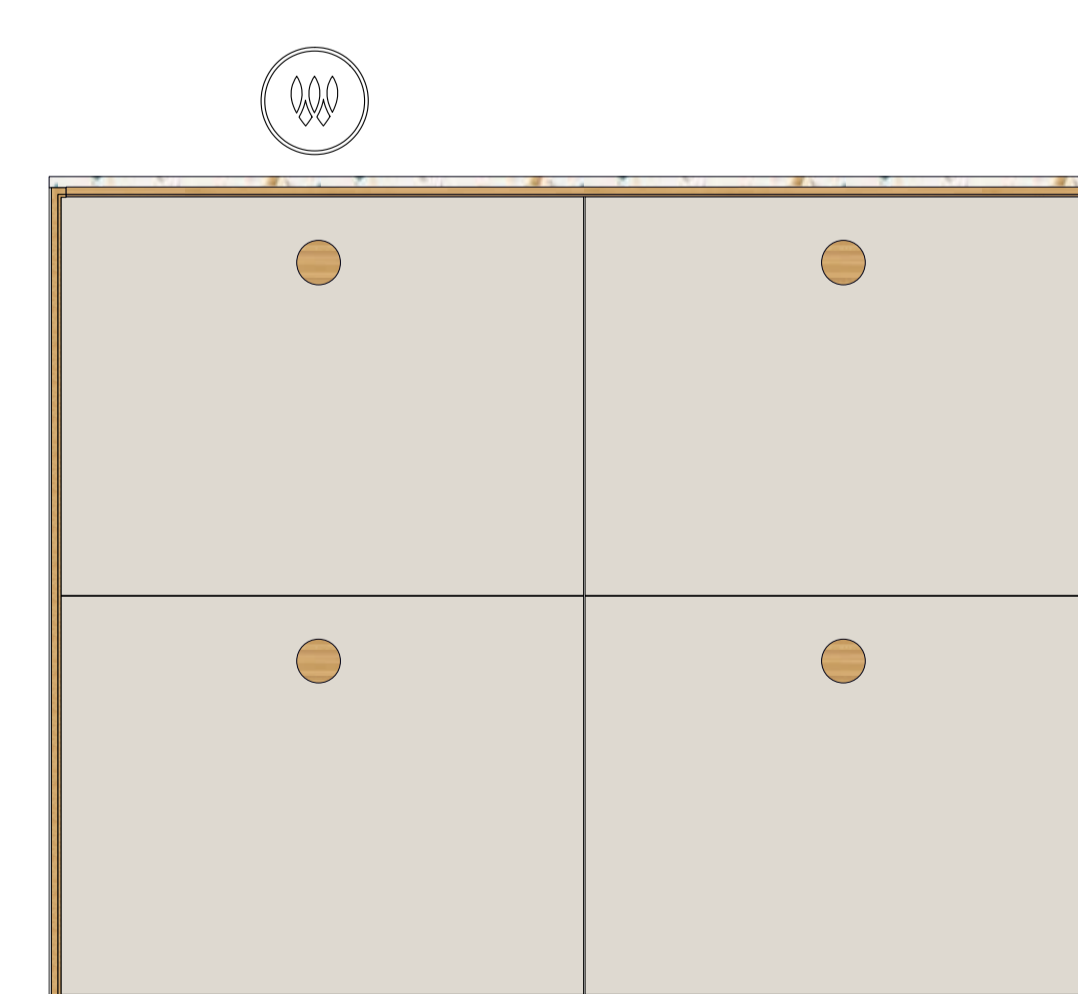
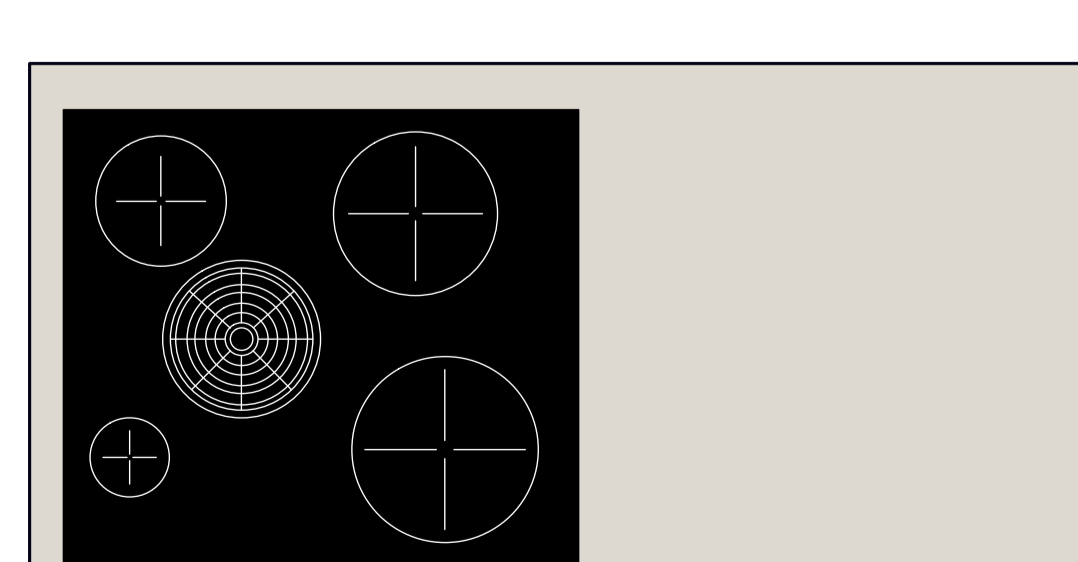

Base Unit 010

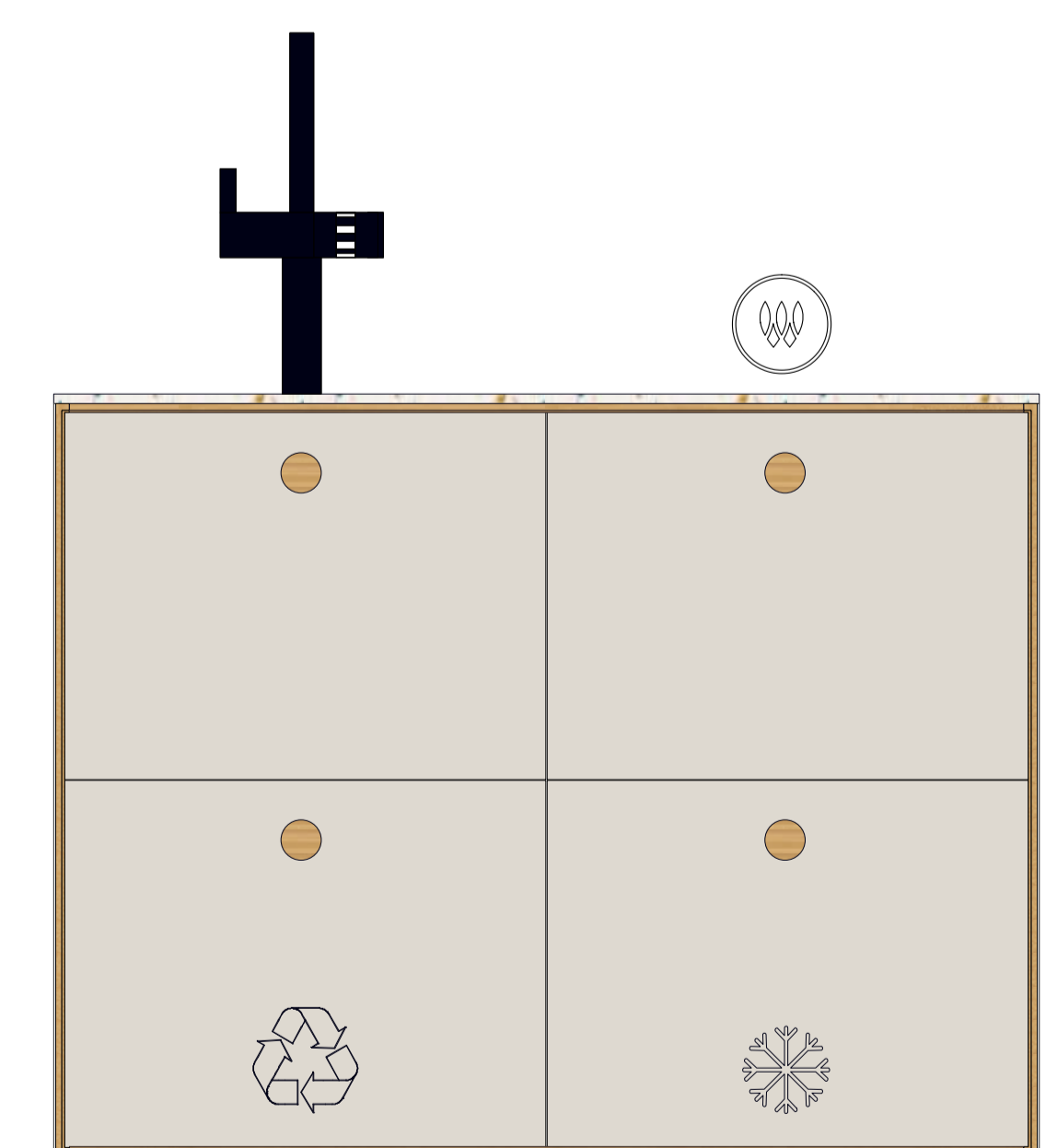
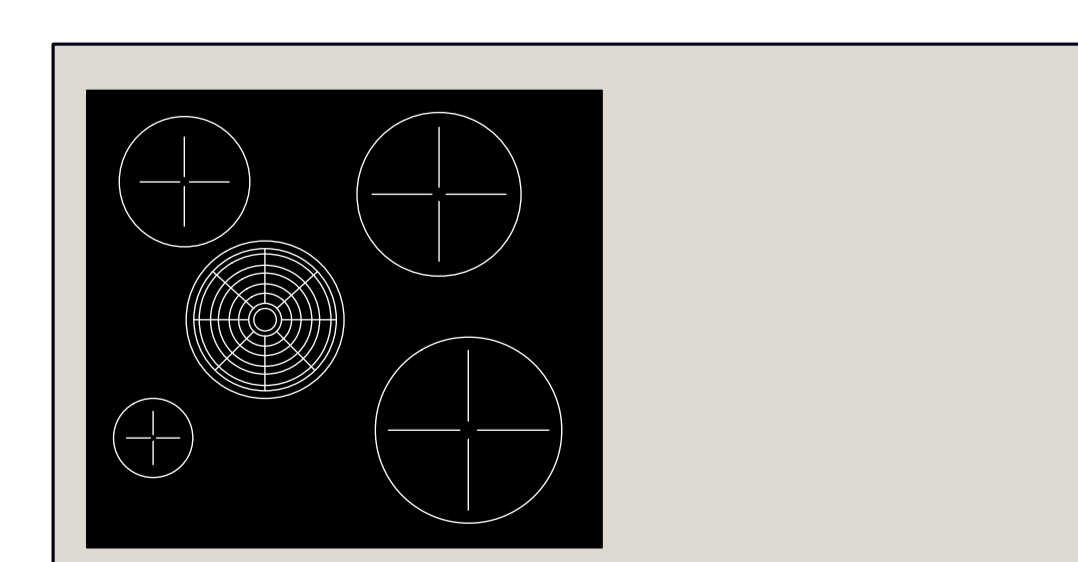

Base Unit 011

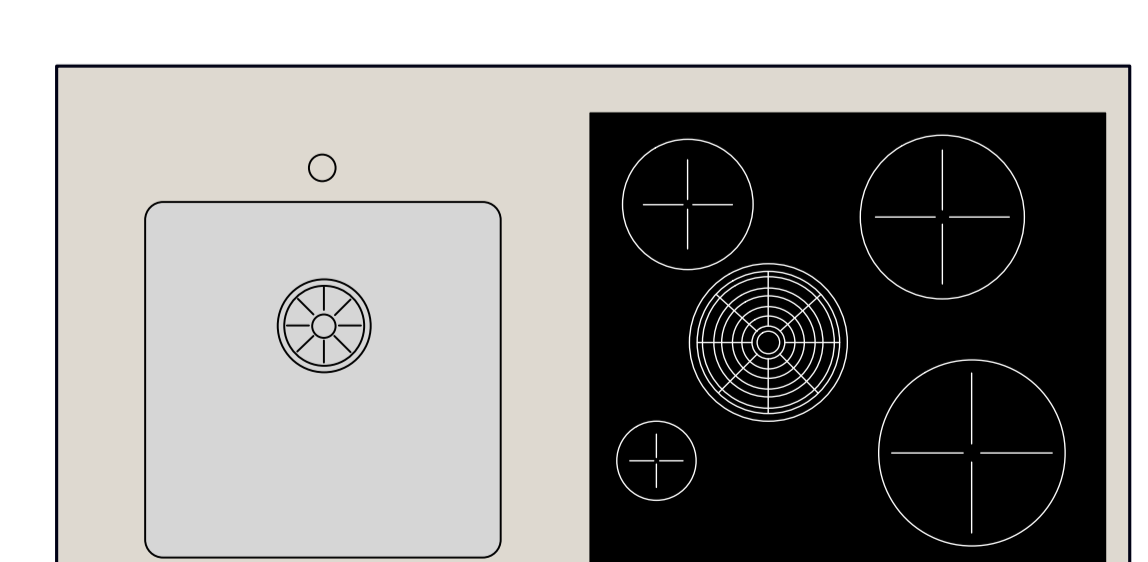

BASE UNITS 180 cm

Legende:  Kochfeld mit Abzug,  Geschirrspüler,  Mülltrennsystem,  Kühlschrank,  Backofen,  Weinkühlchrank,

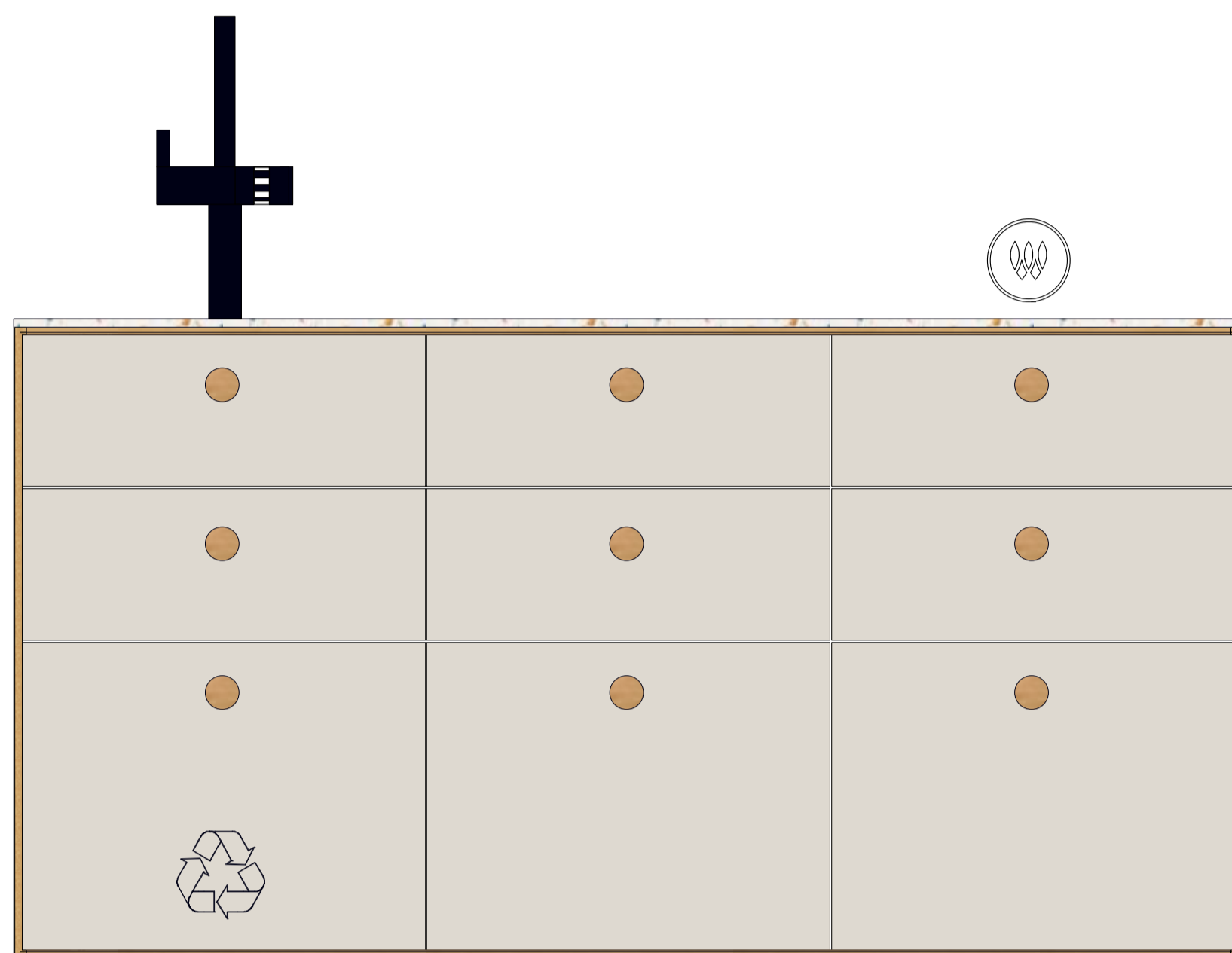

Base Unit 012

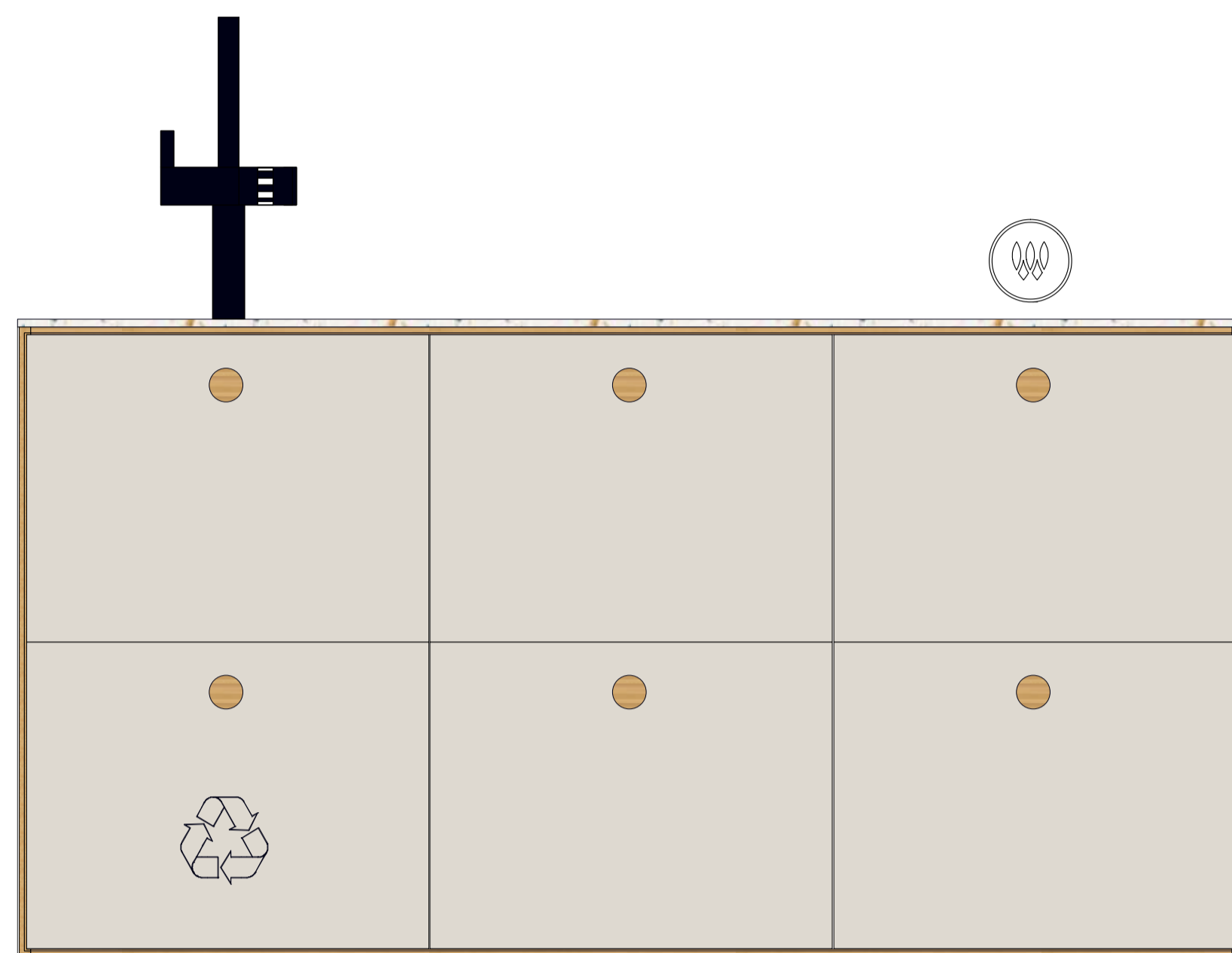
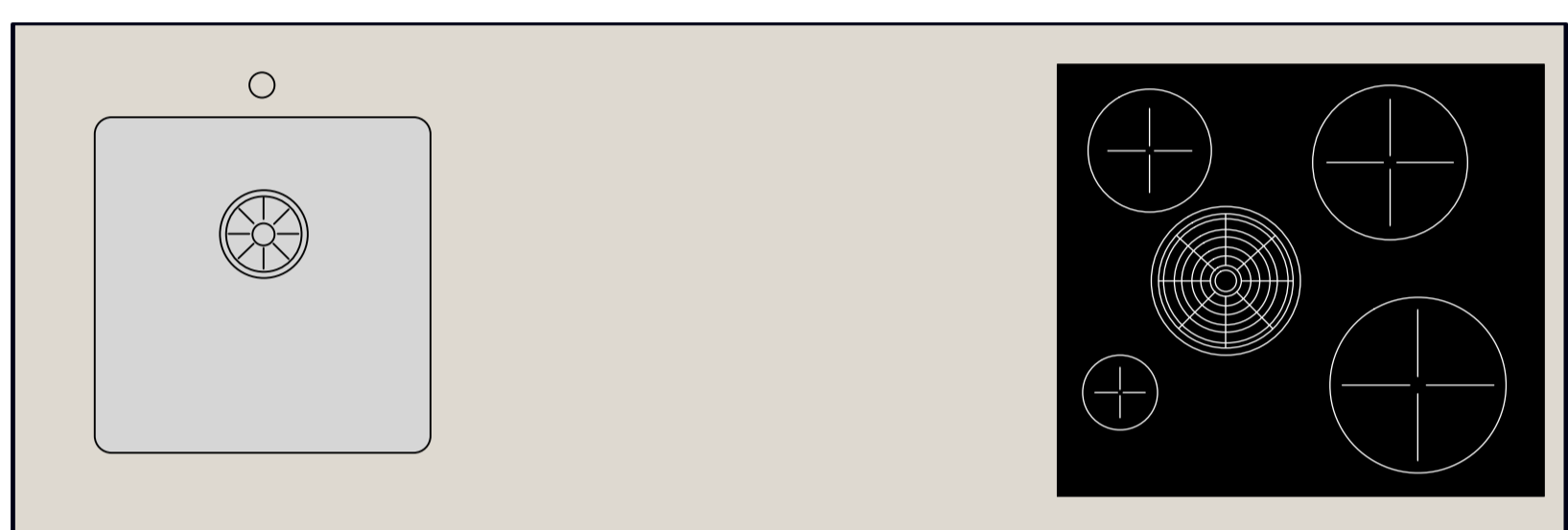

Base Unit 013

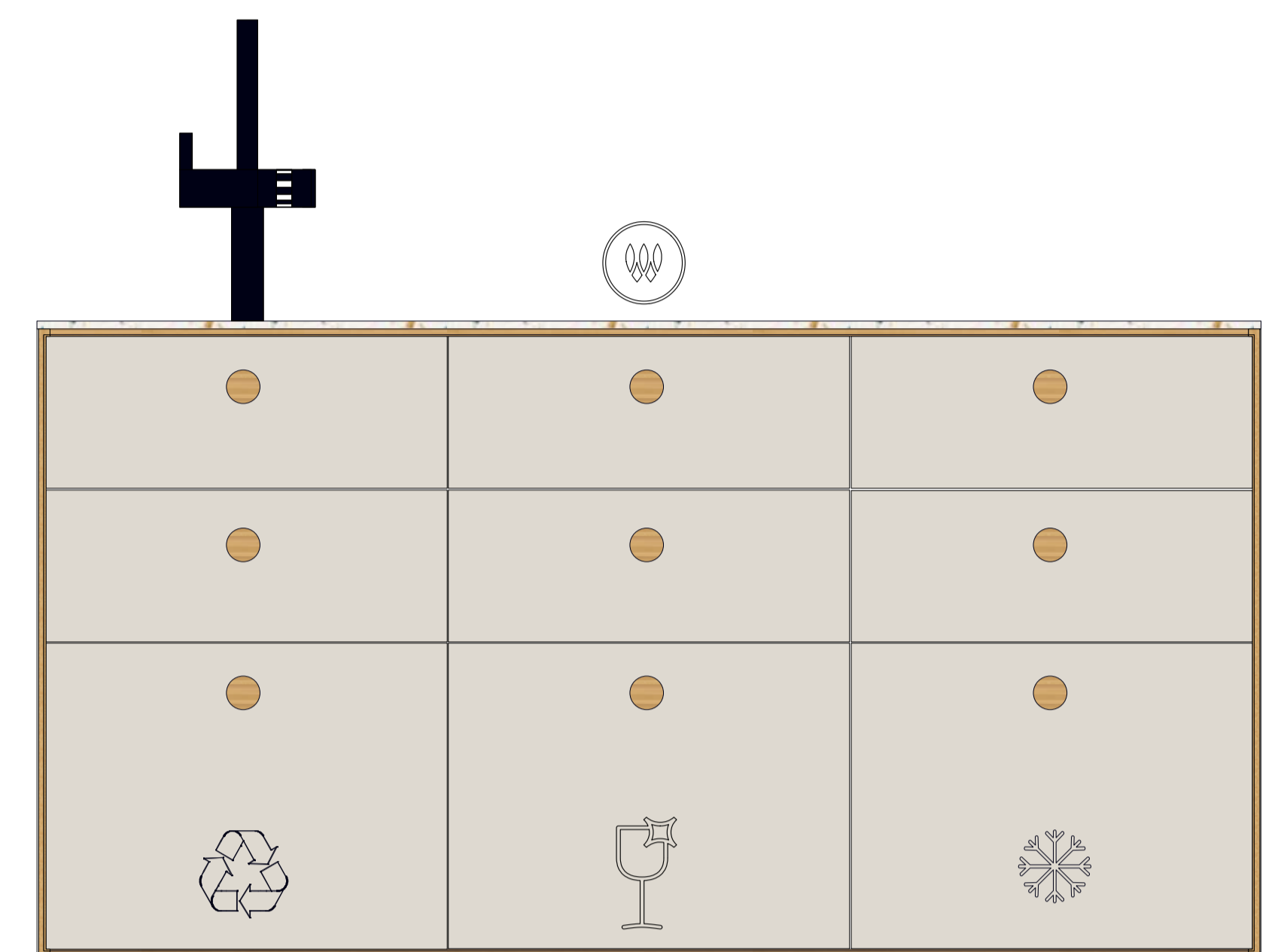

Base Unit 014

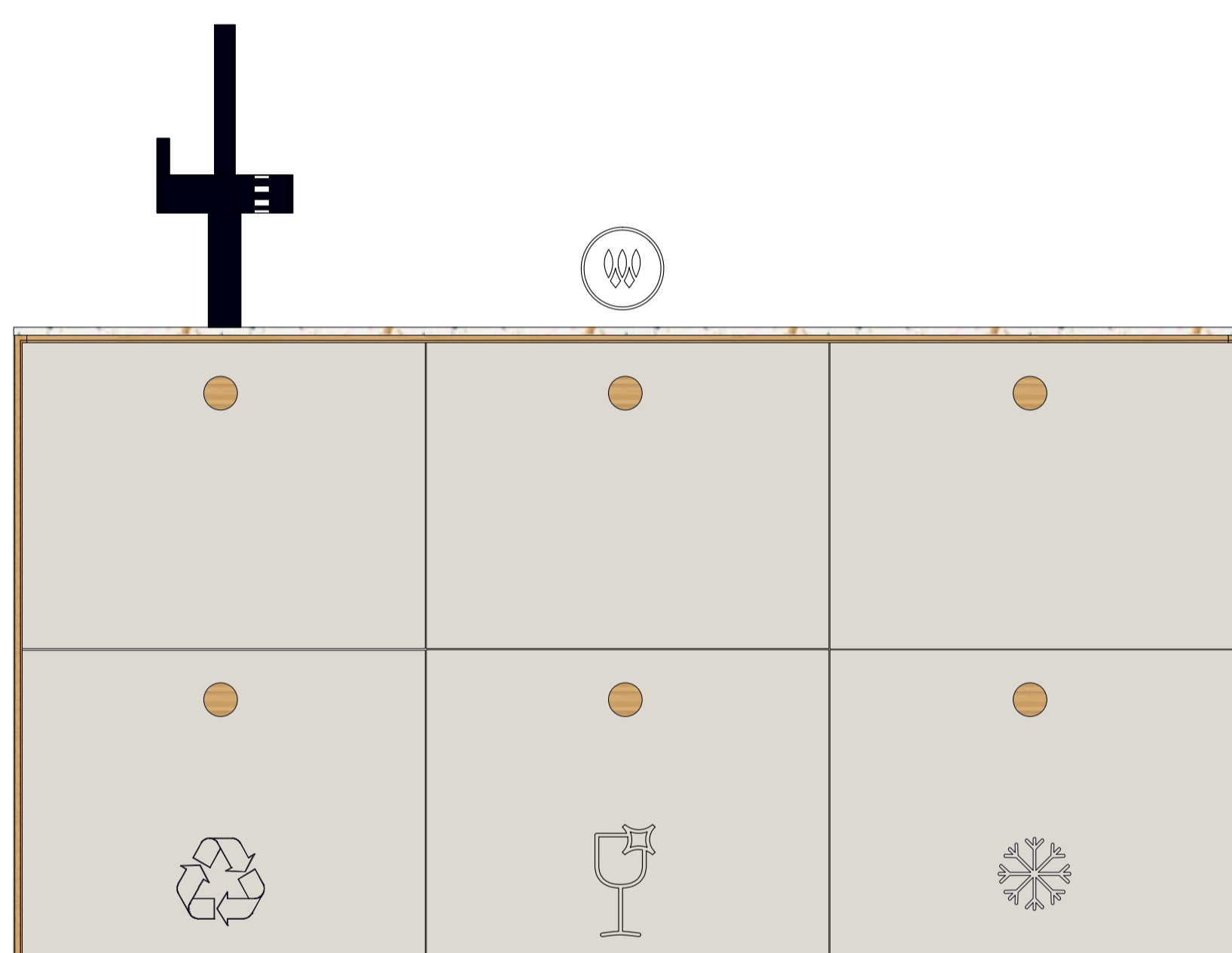
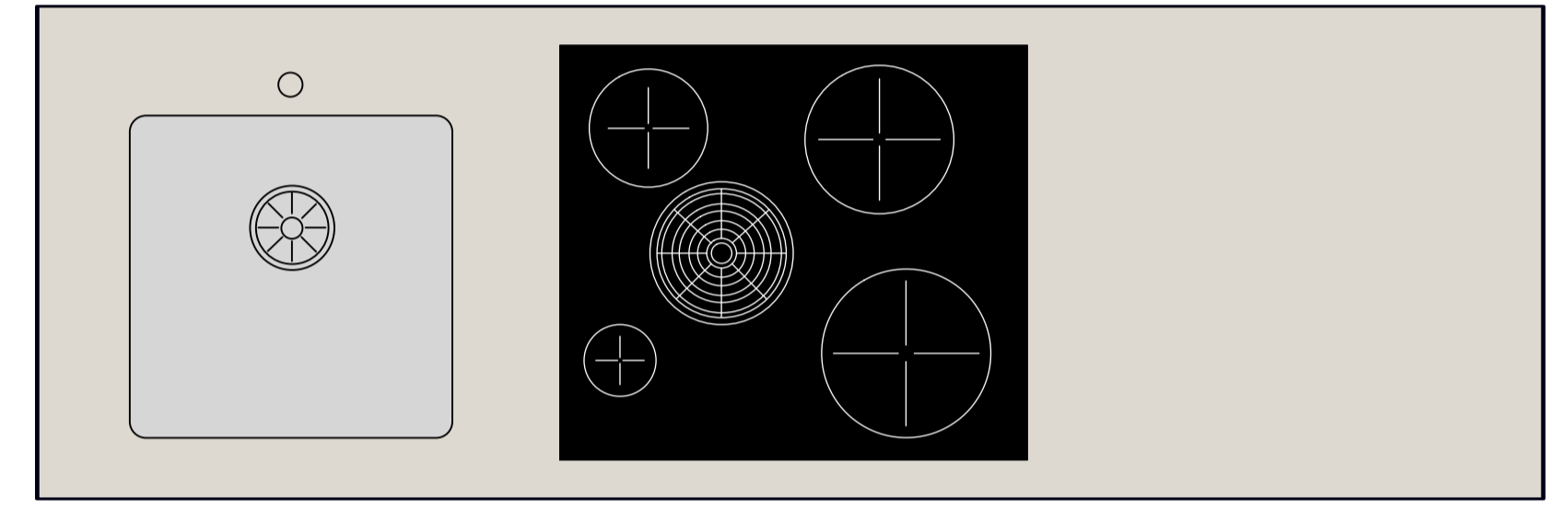

Base Unit 015

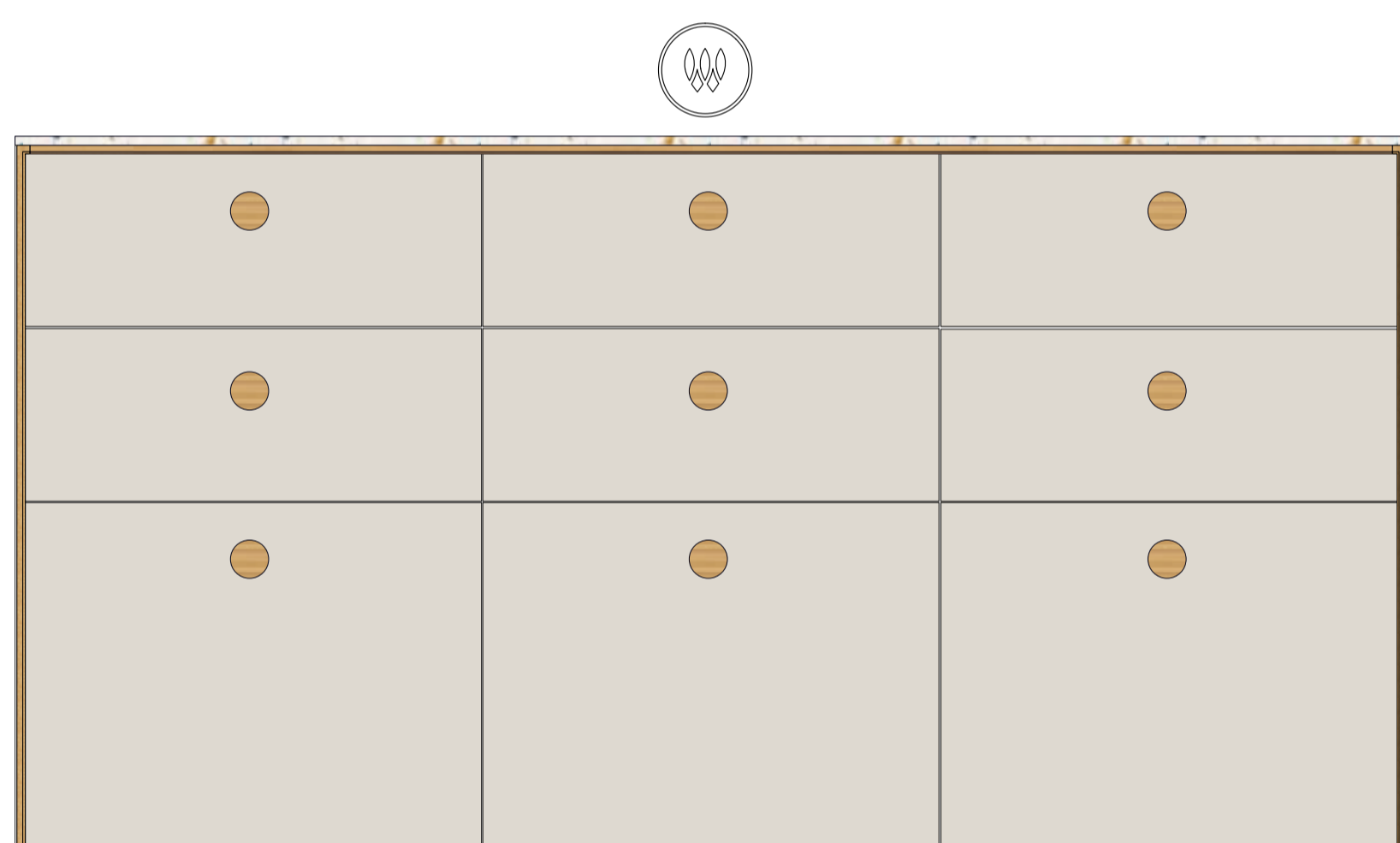
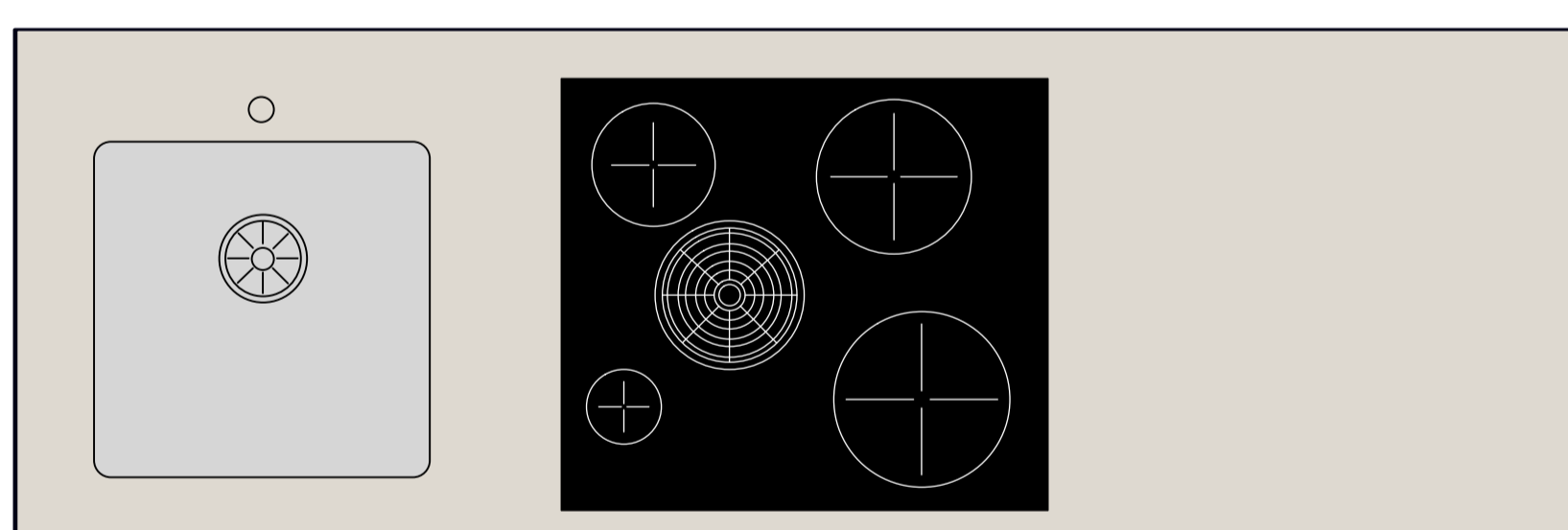

Base Unit 016

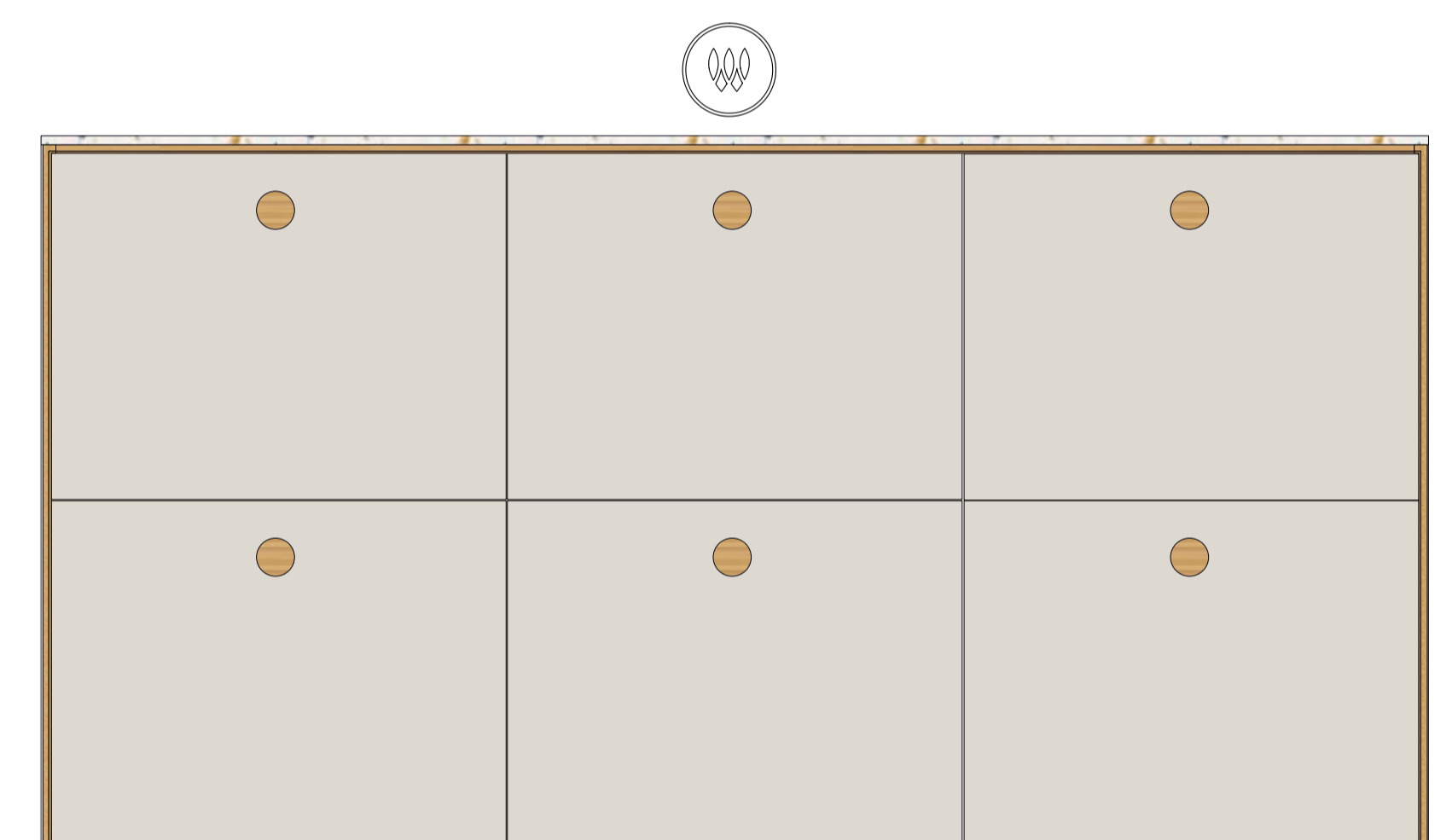
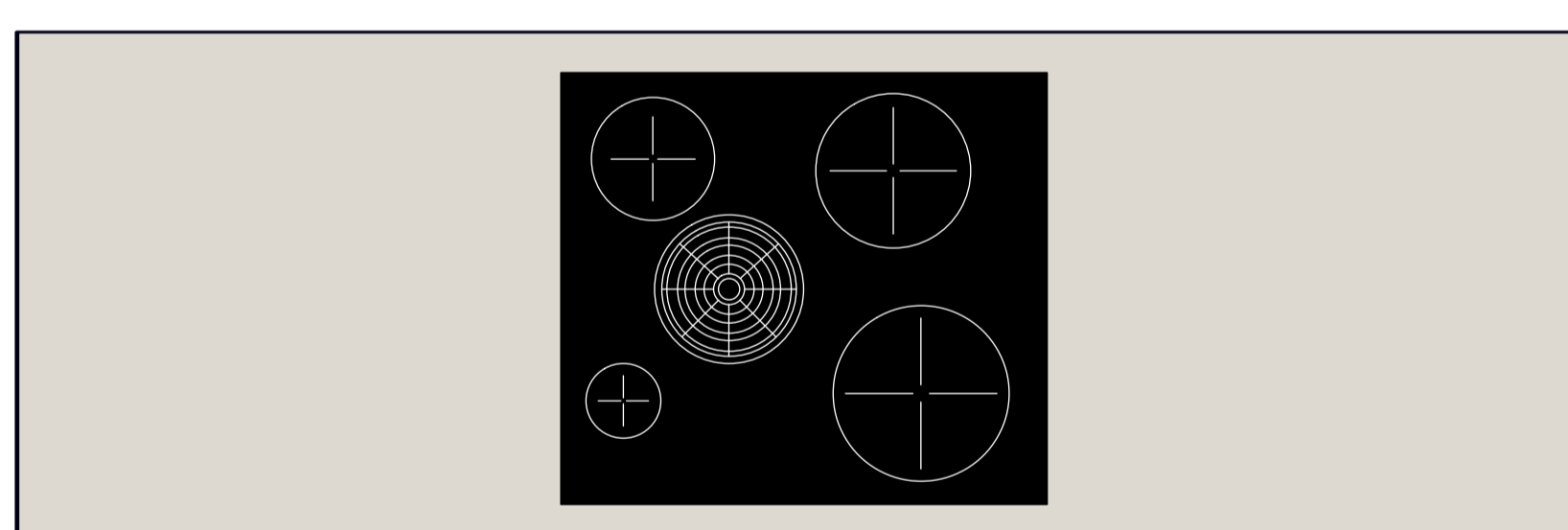

Base Unit 017

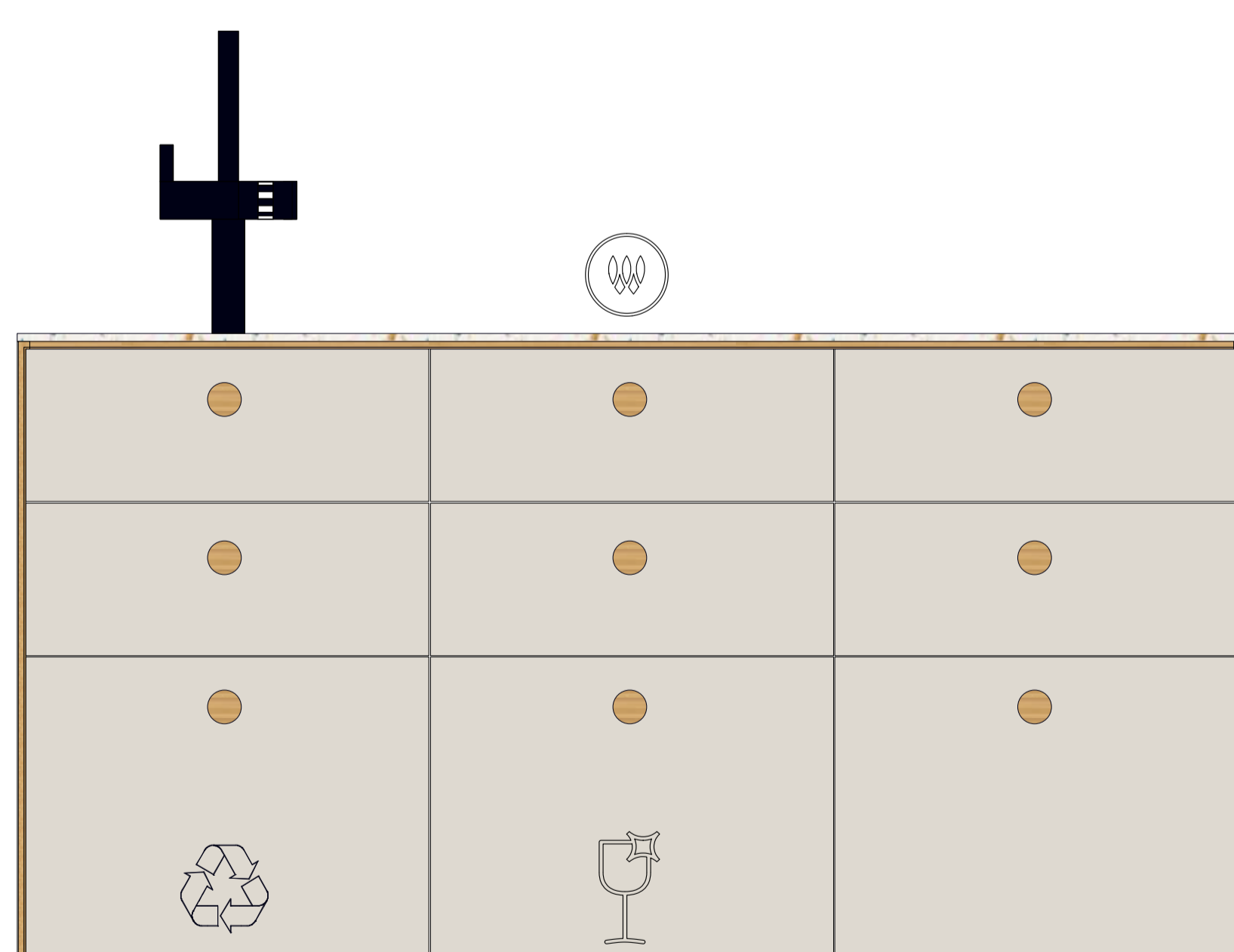
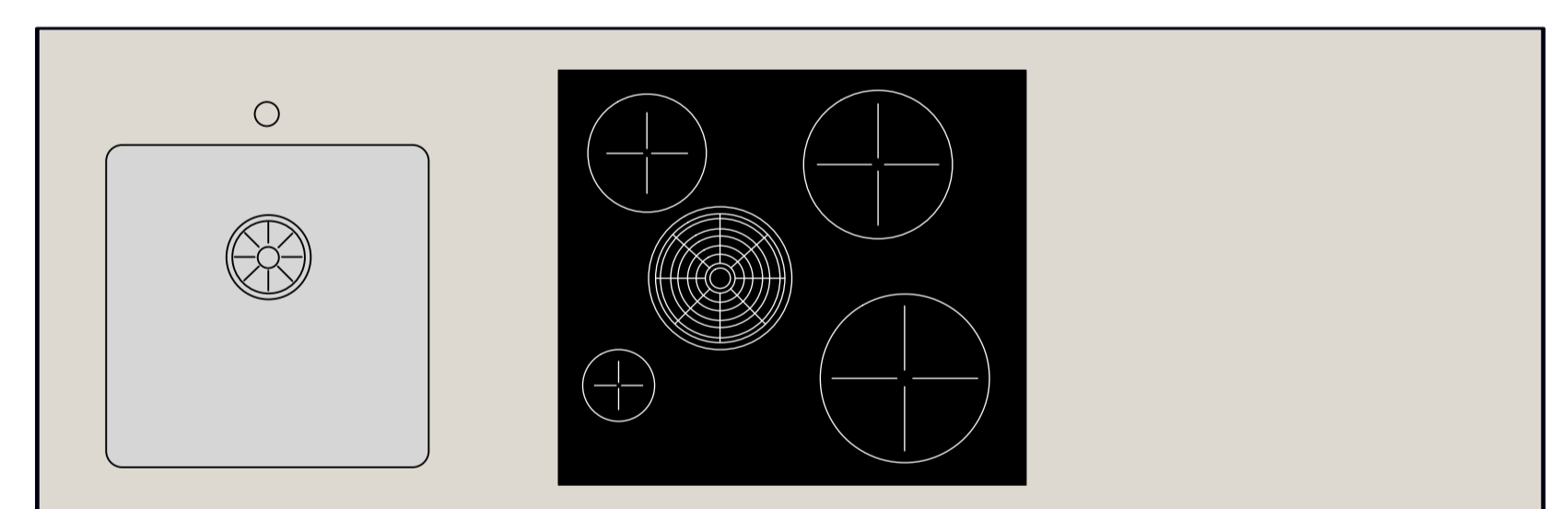

Base Unit 018

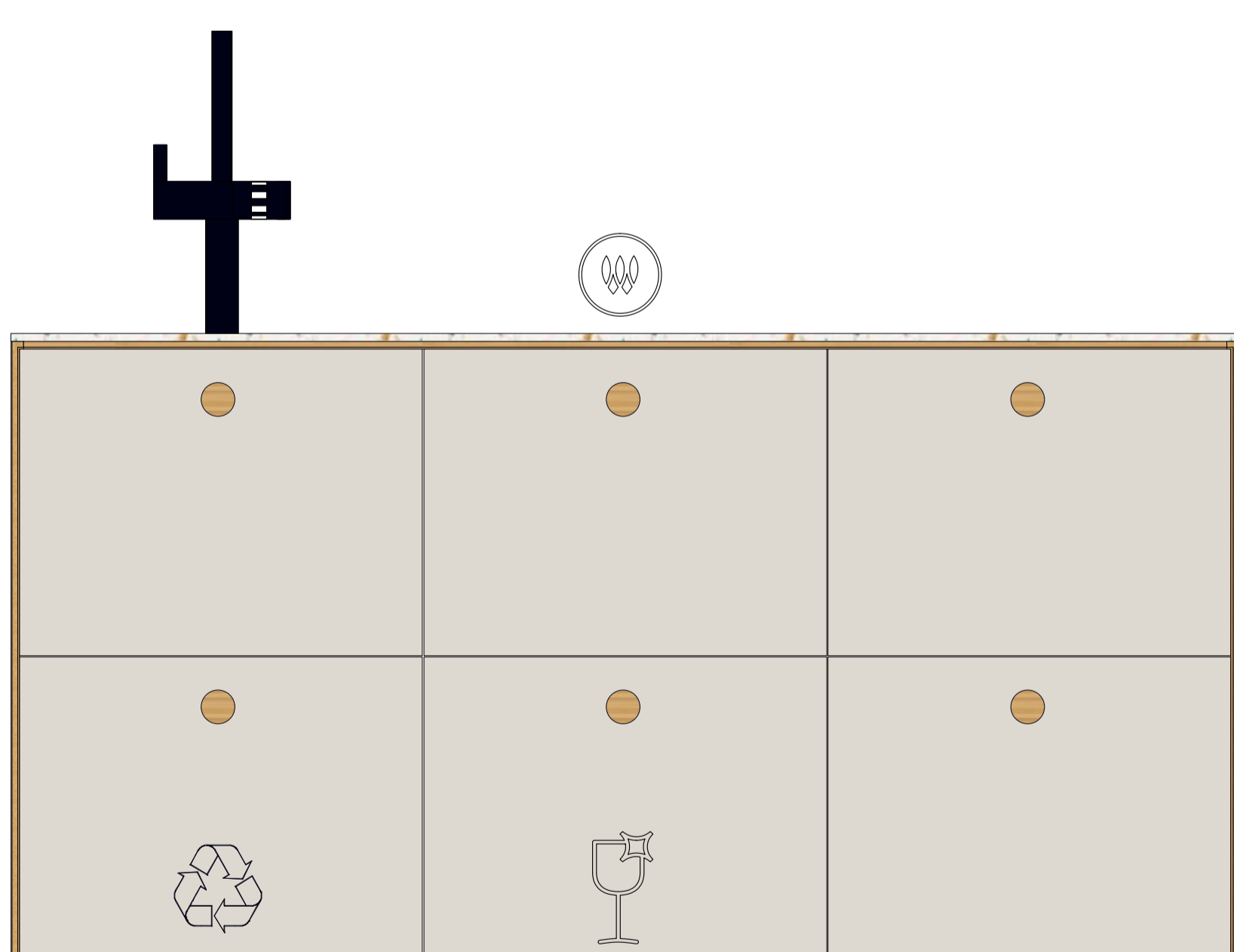
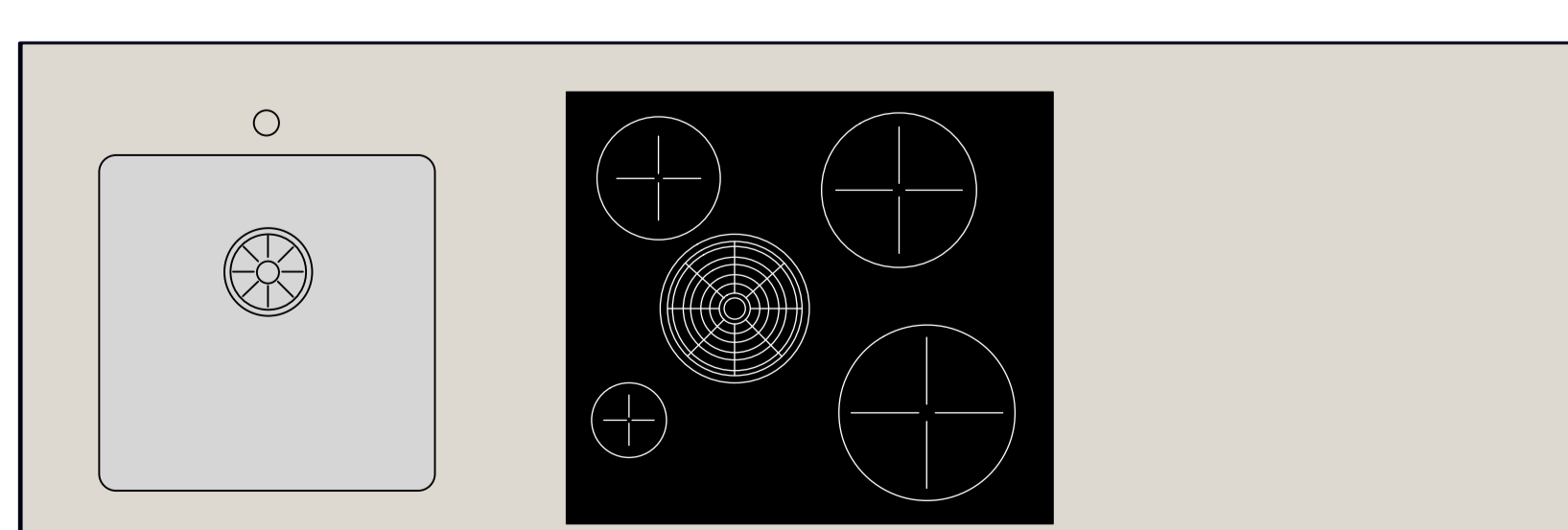

Base Unit 019

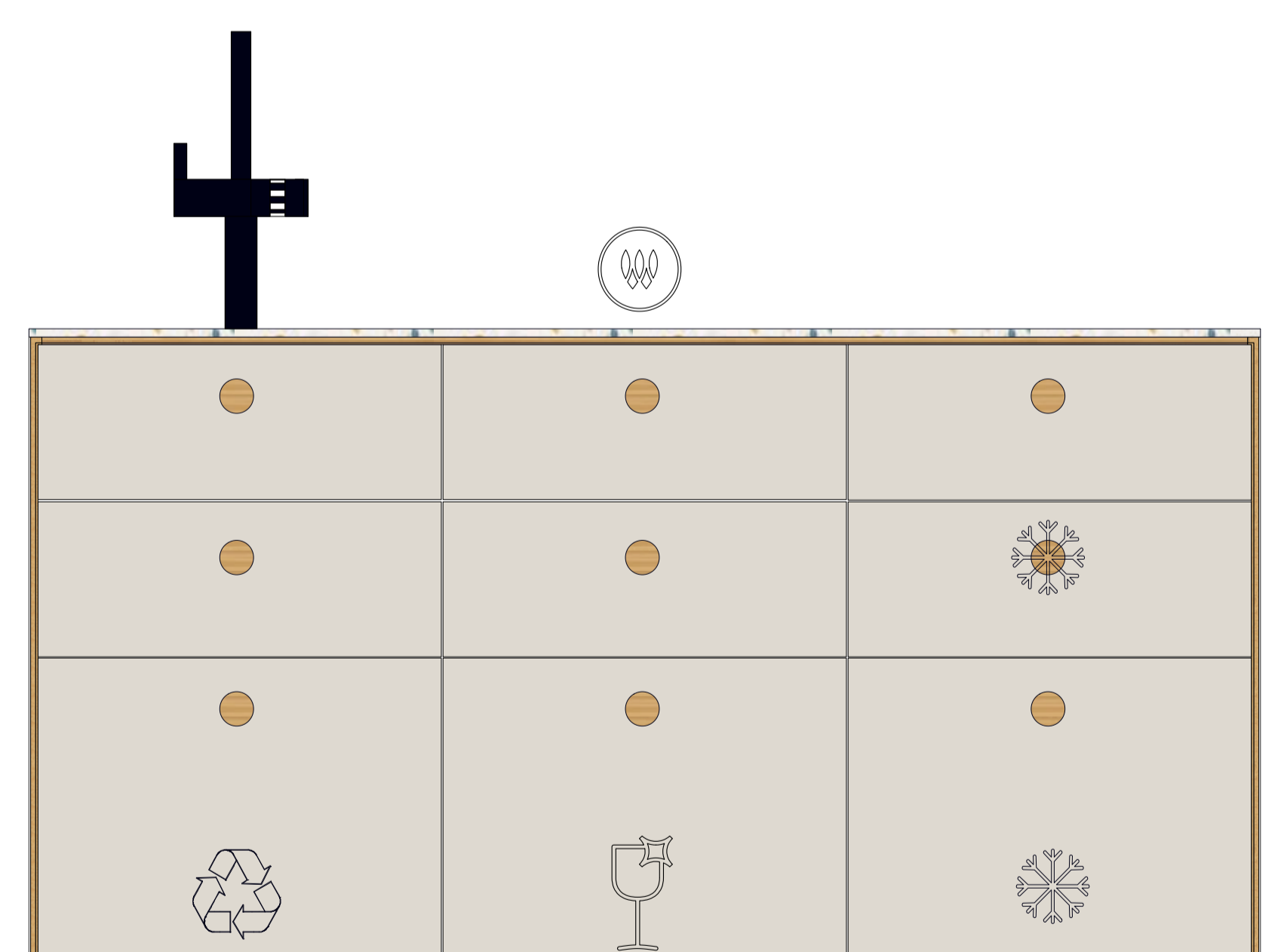
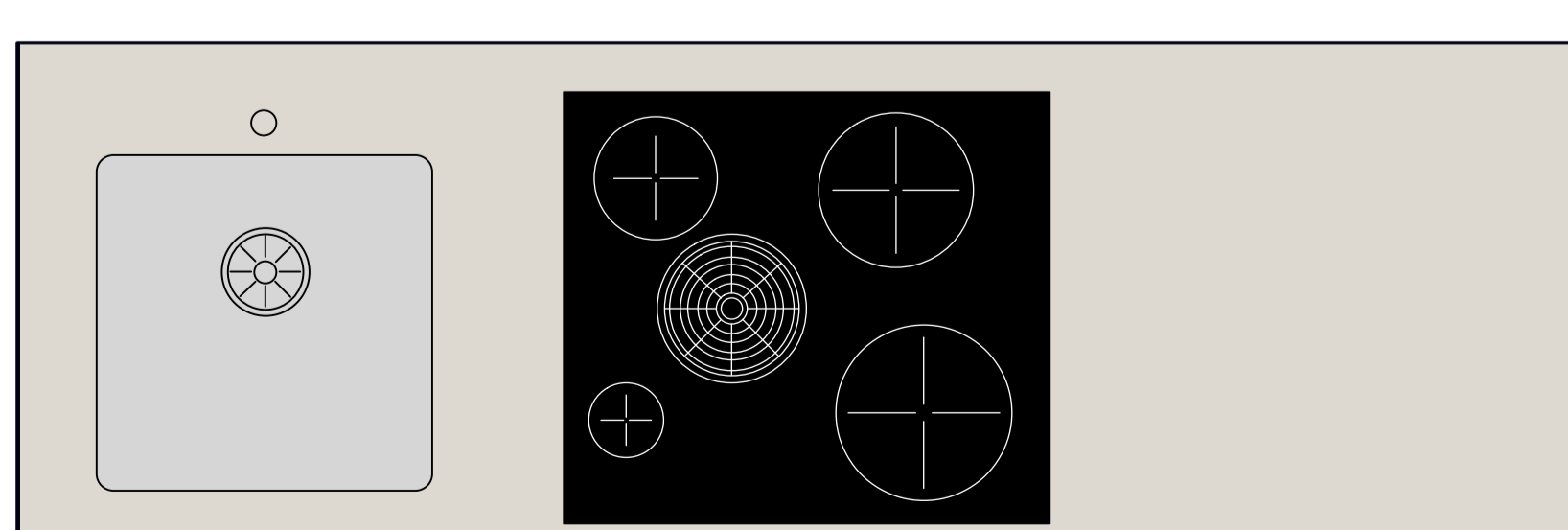

Base Unit 020

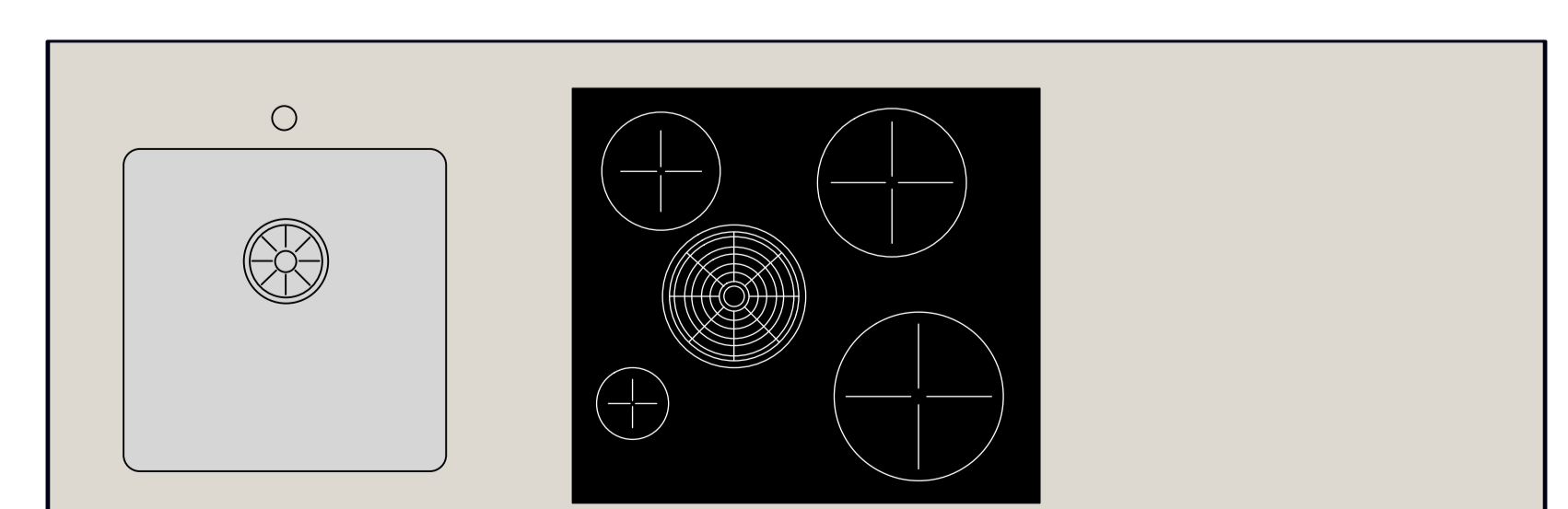

BASE UNITS 180 cm

Legende:  Kochfeld mit Abzug,  Geschirrspüler,  Mülltrennsystem,  Kühlschrank,  Backofen,  Weinkühlchrank,

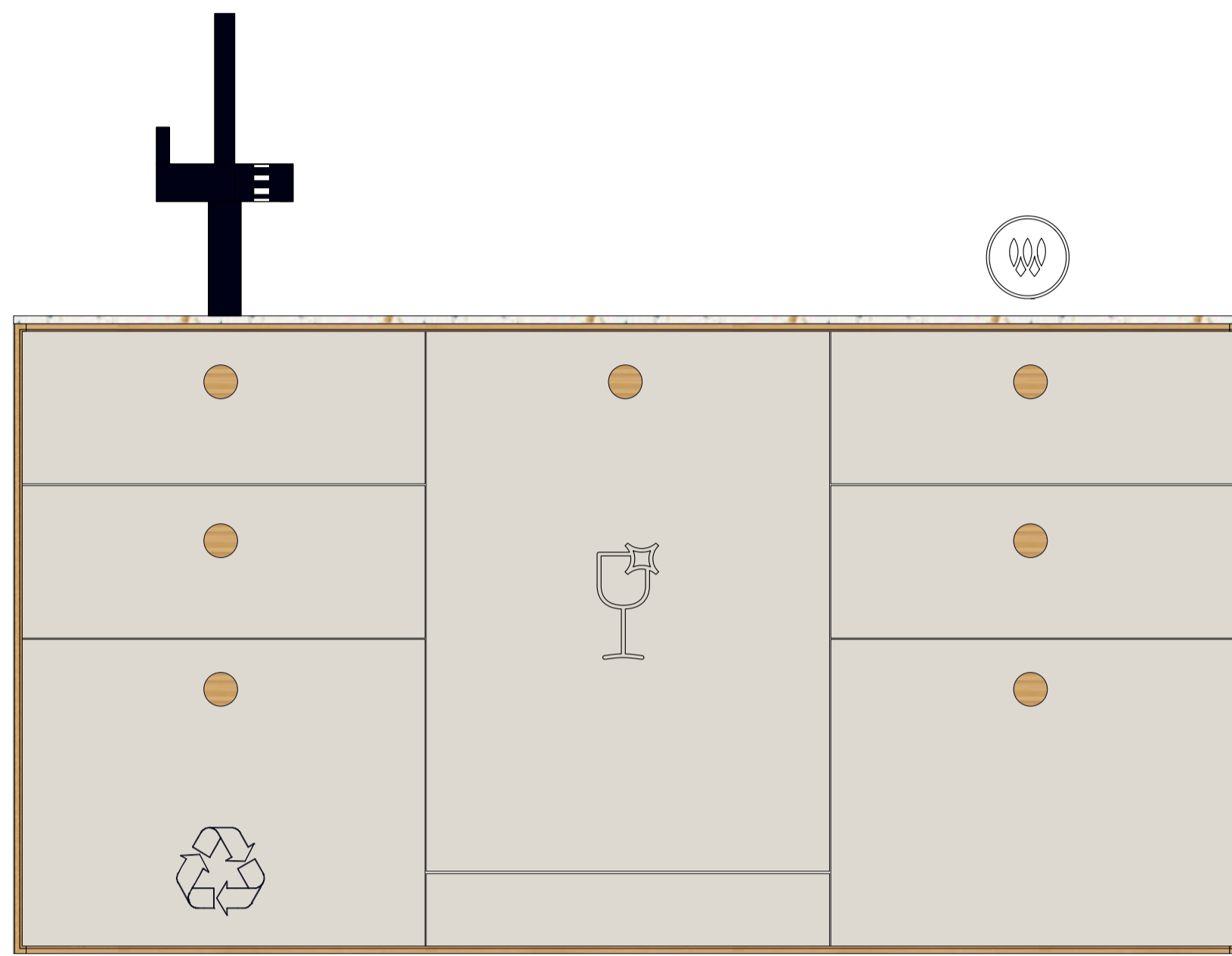

Base Unit 021

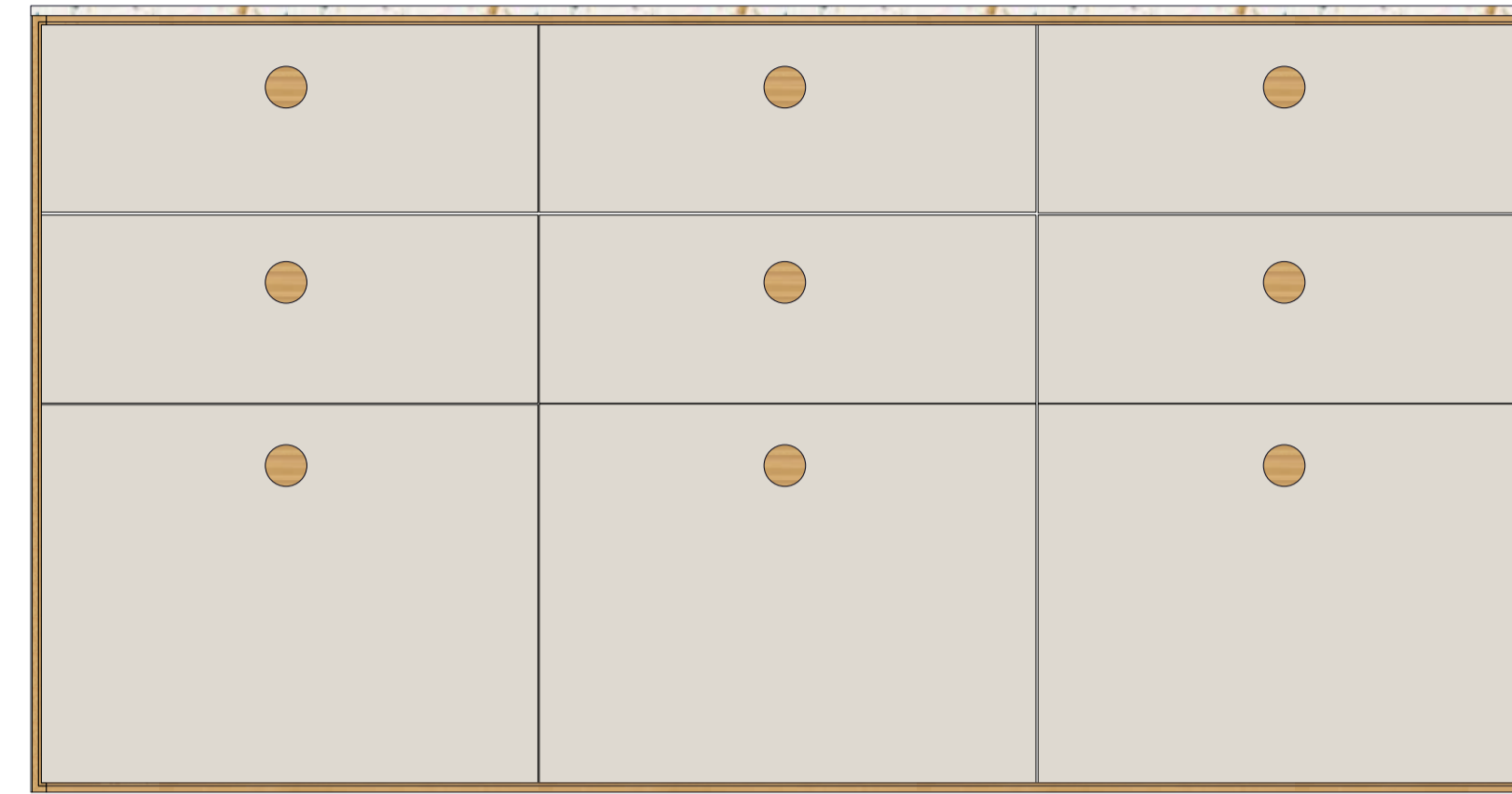

Base Unit 022

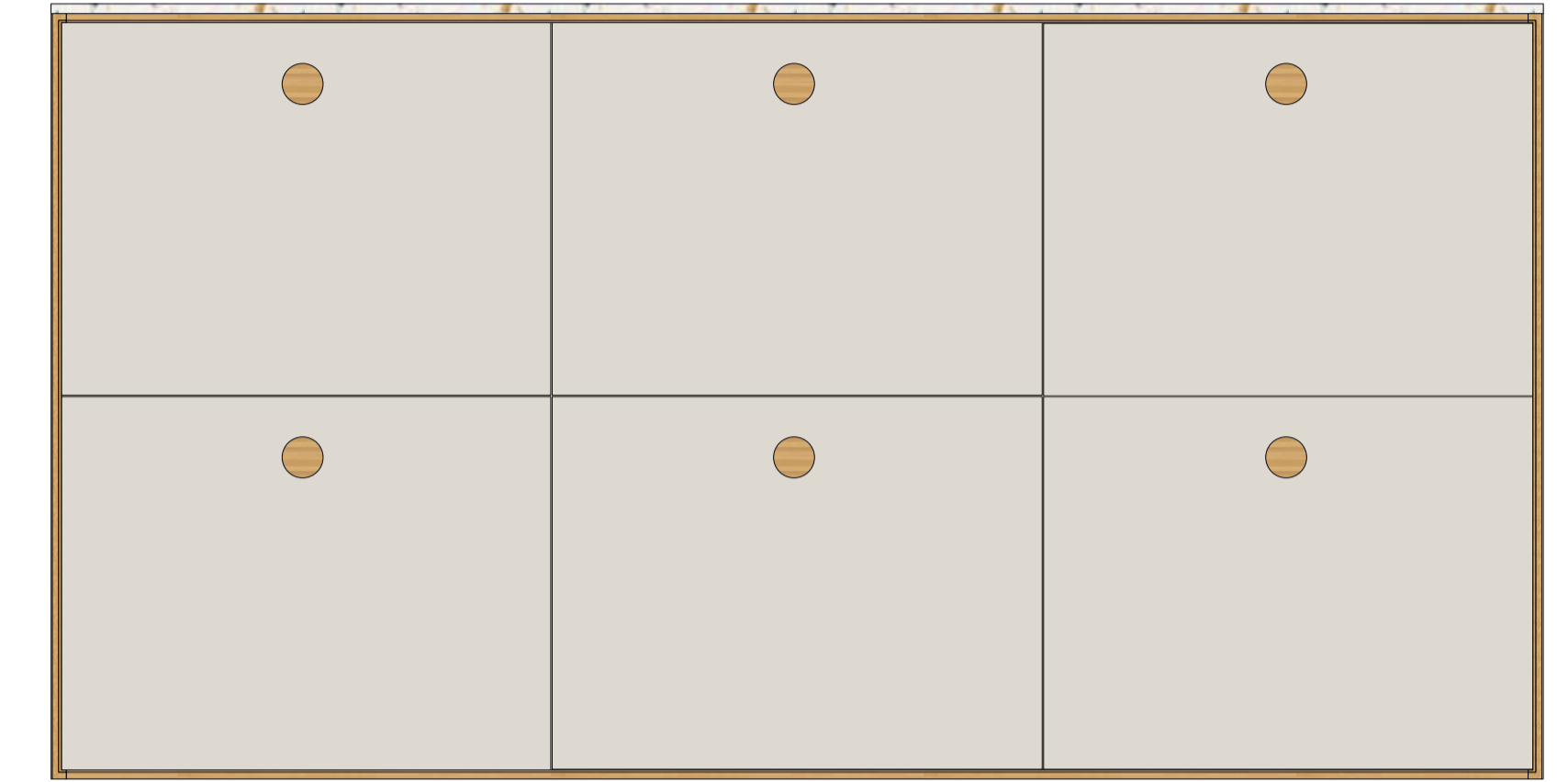

Base Unit 023

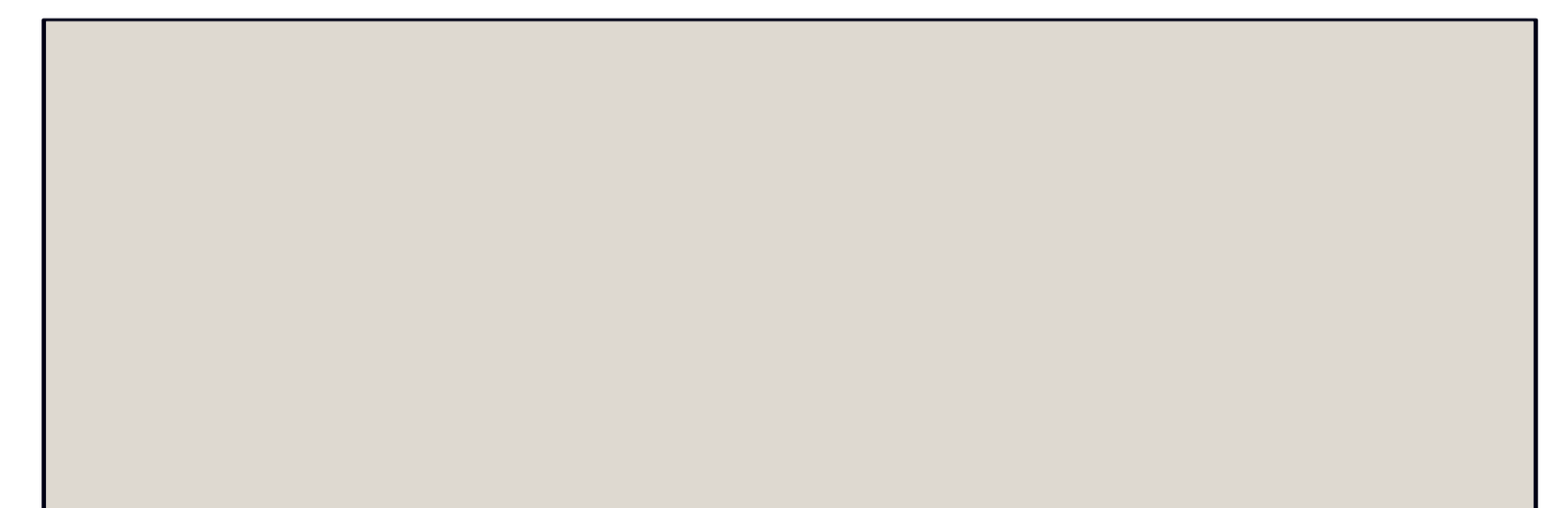
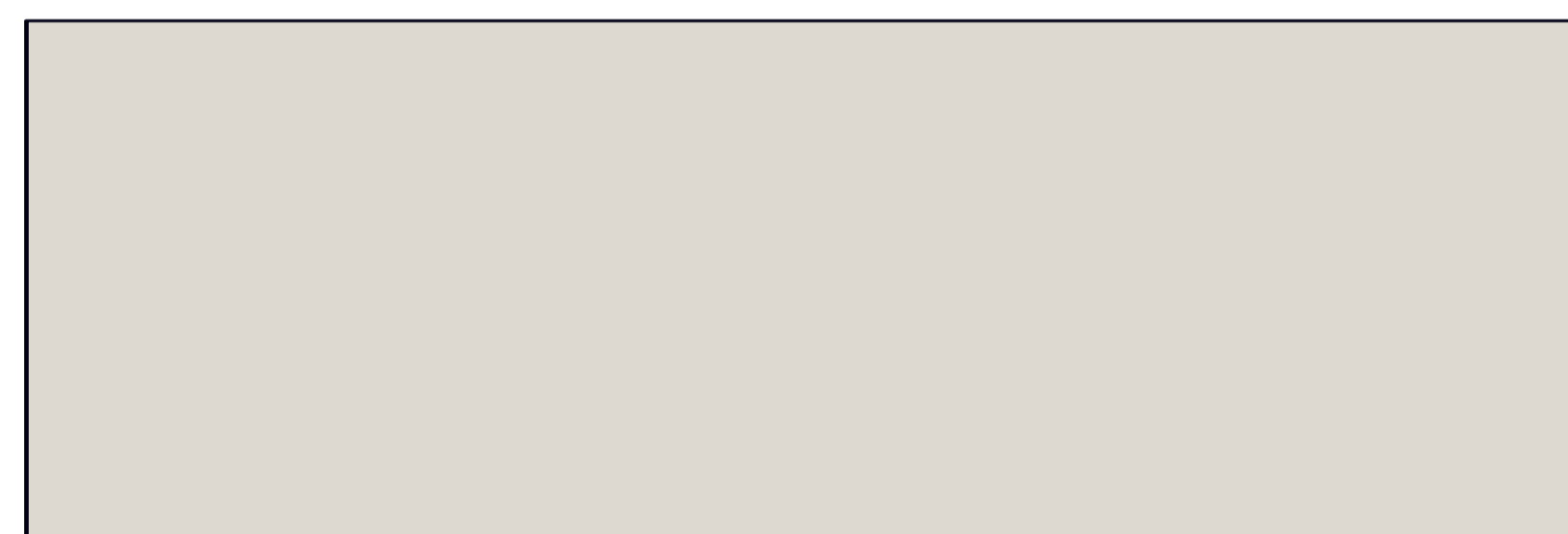
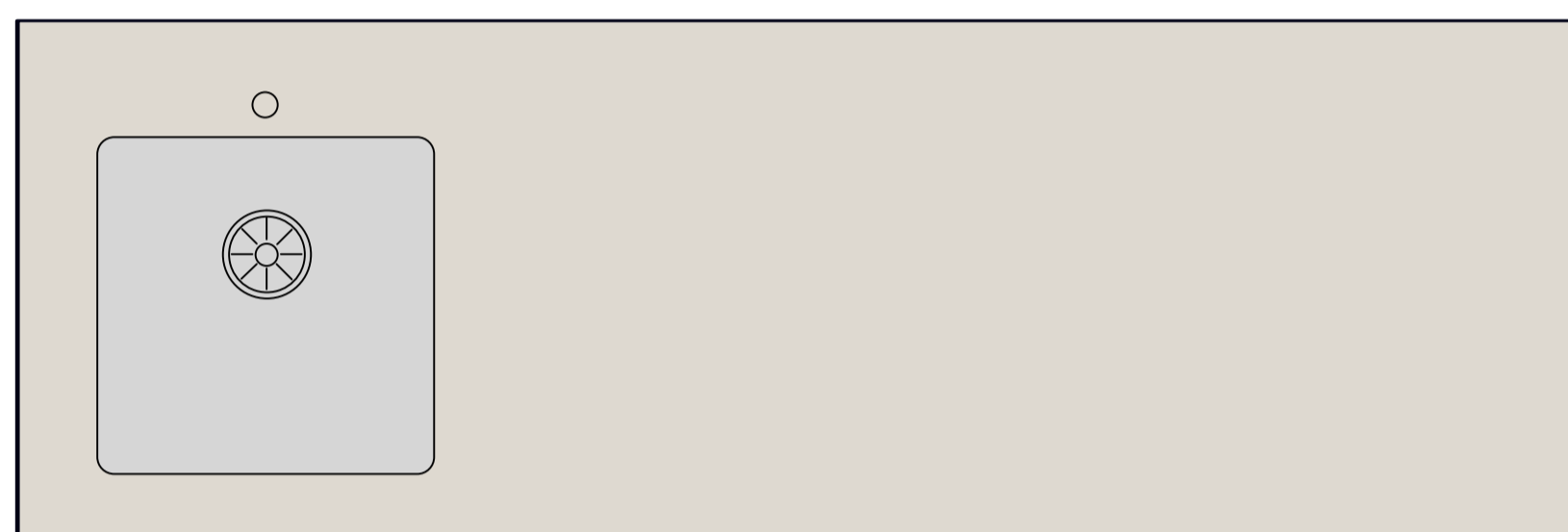

Base Unit 024



Base Unit 025

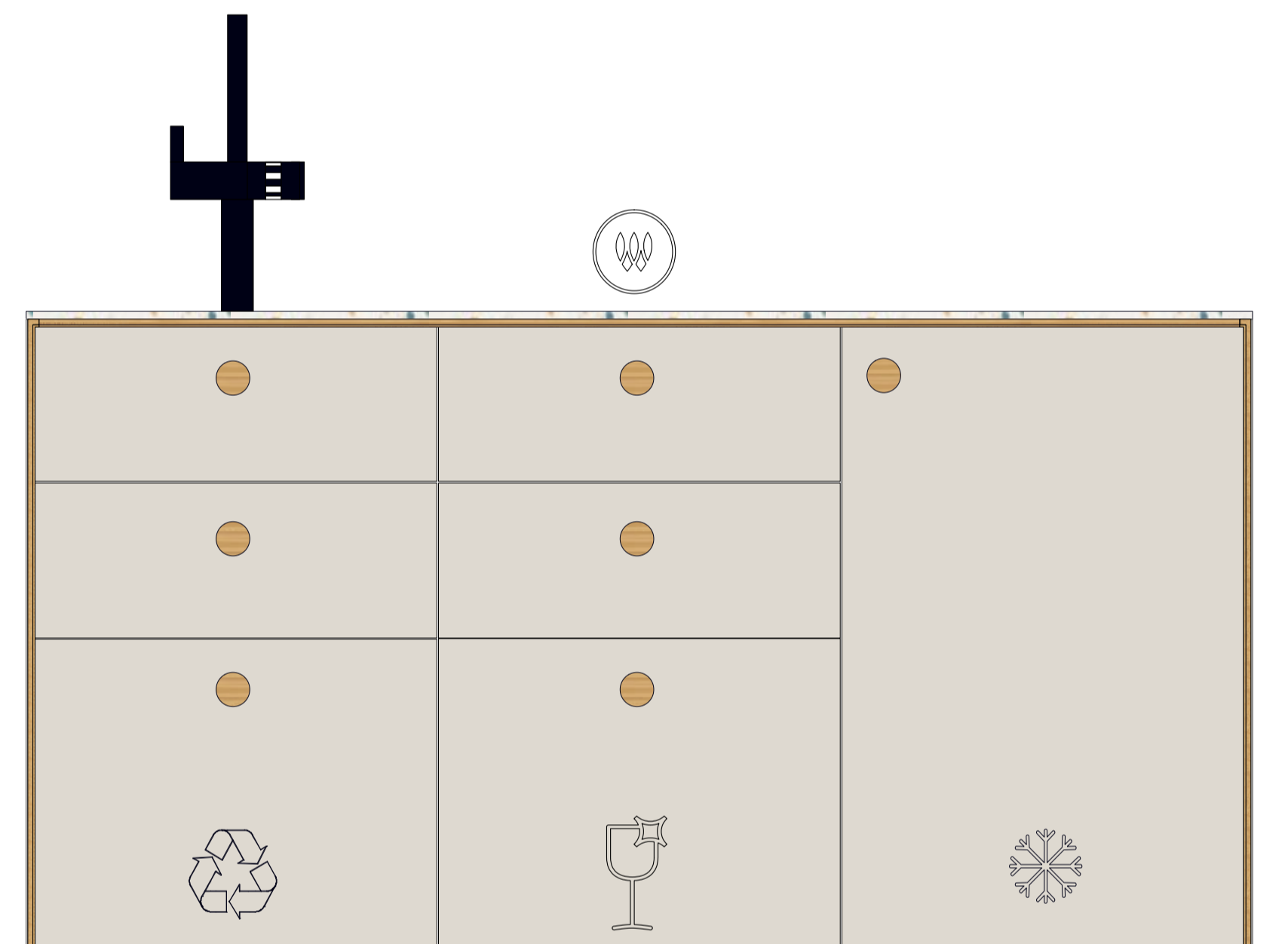

Base Unit 026

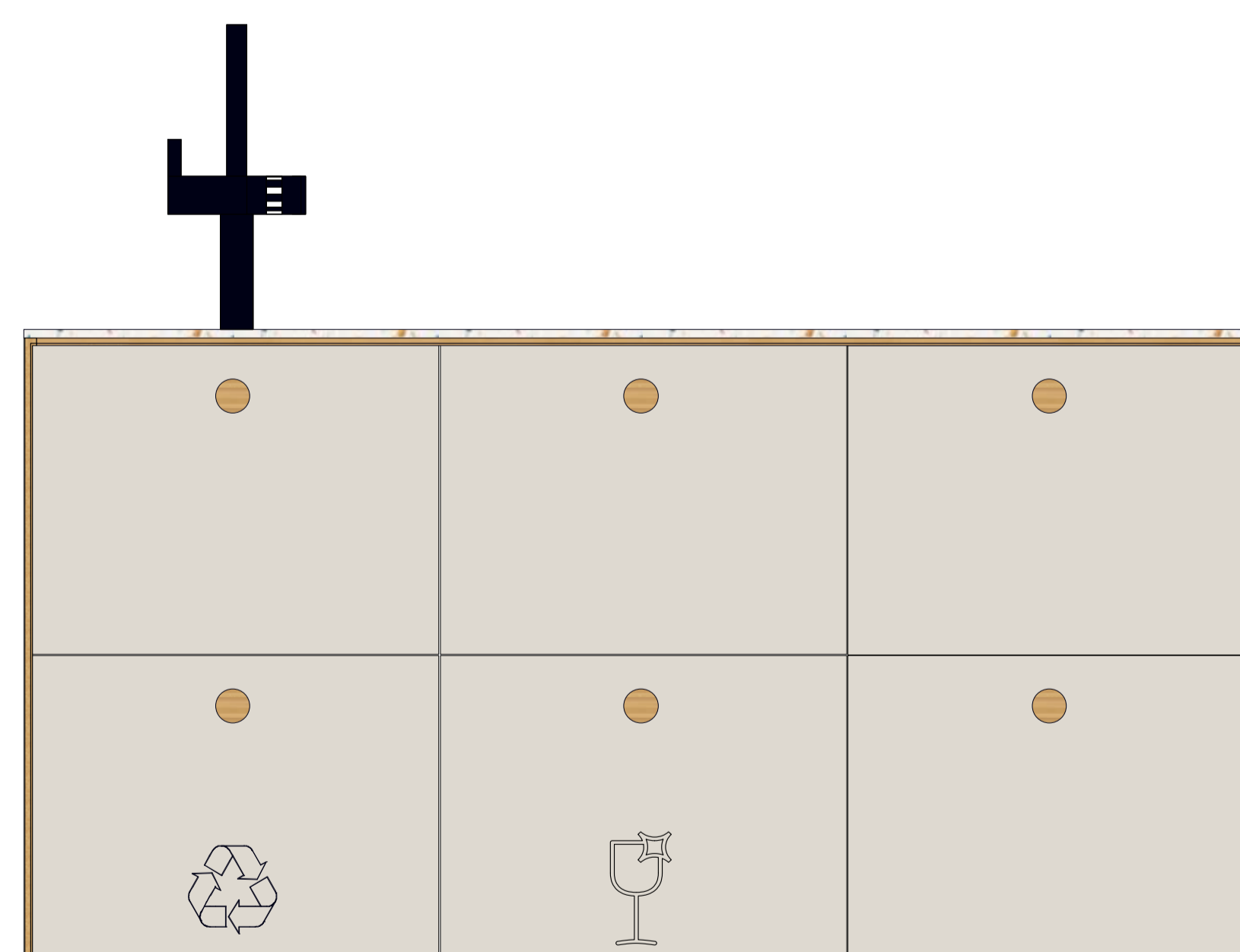
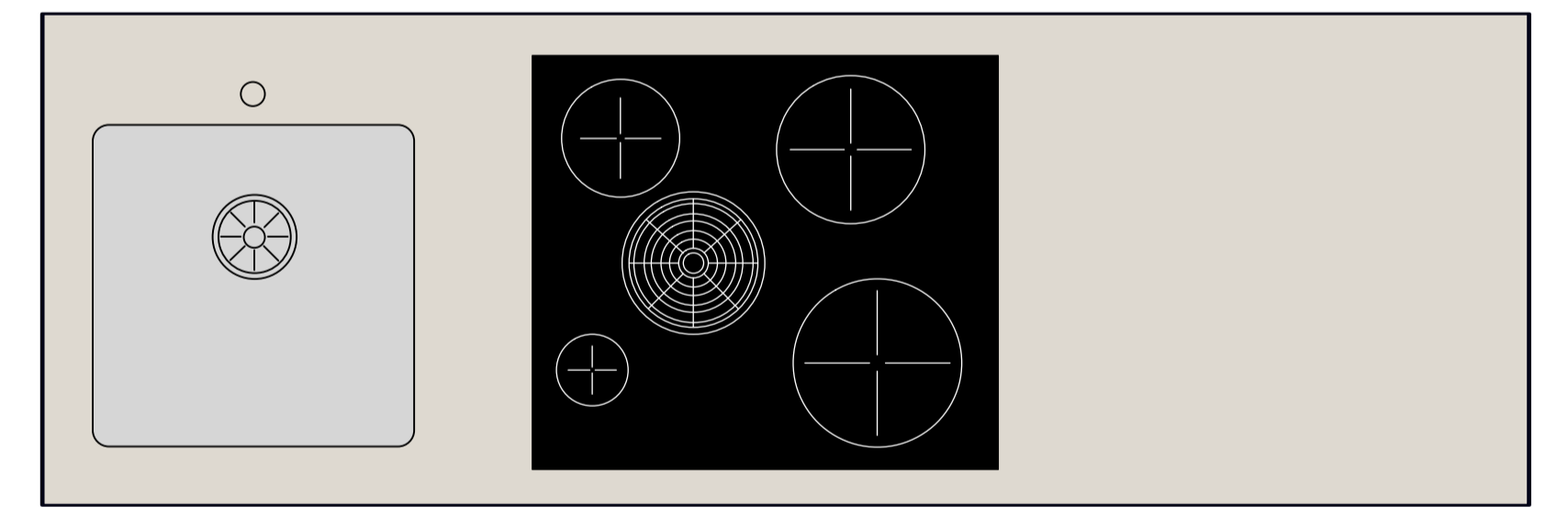
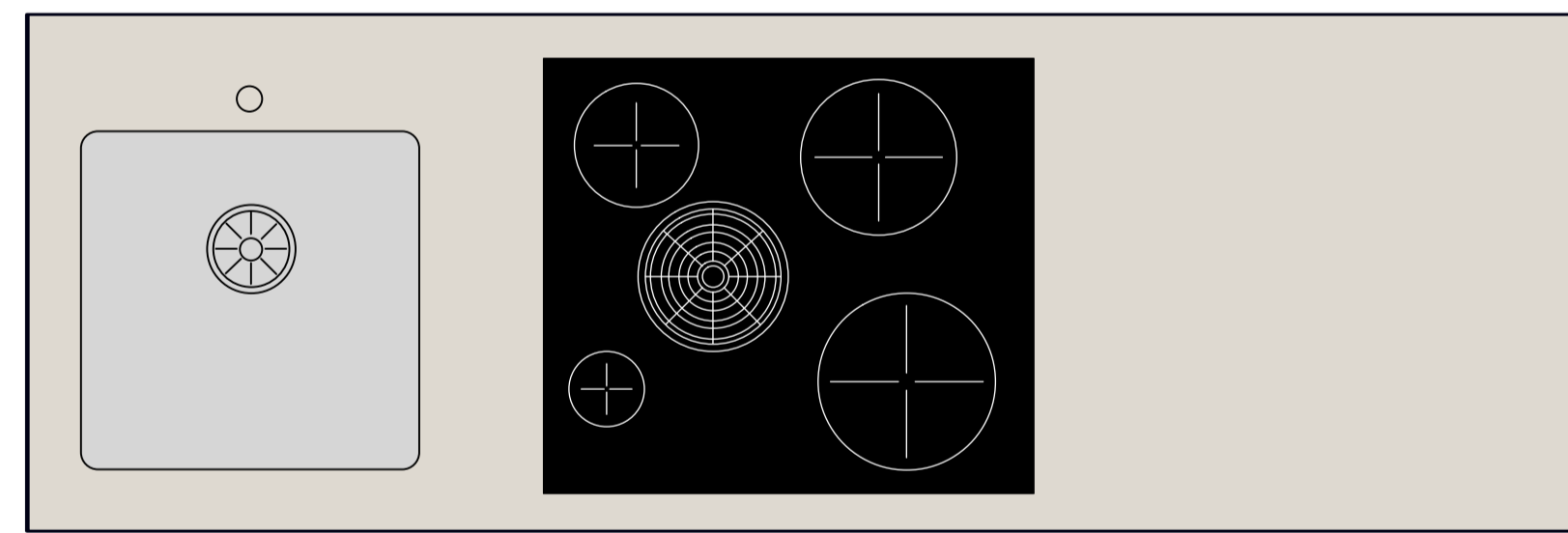
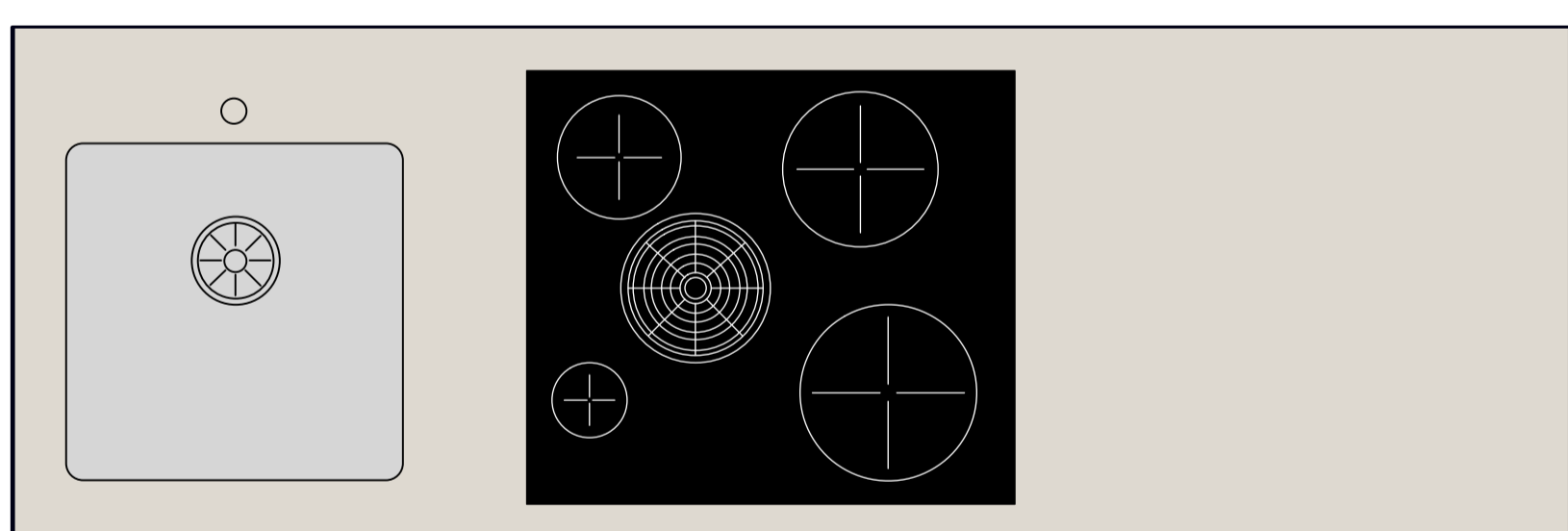

Base Unit 027



Base Unit 028

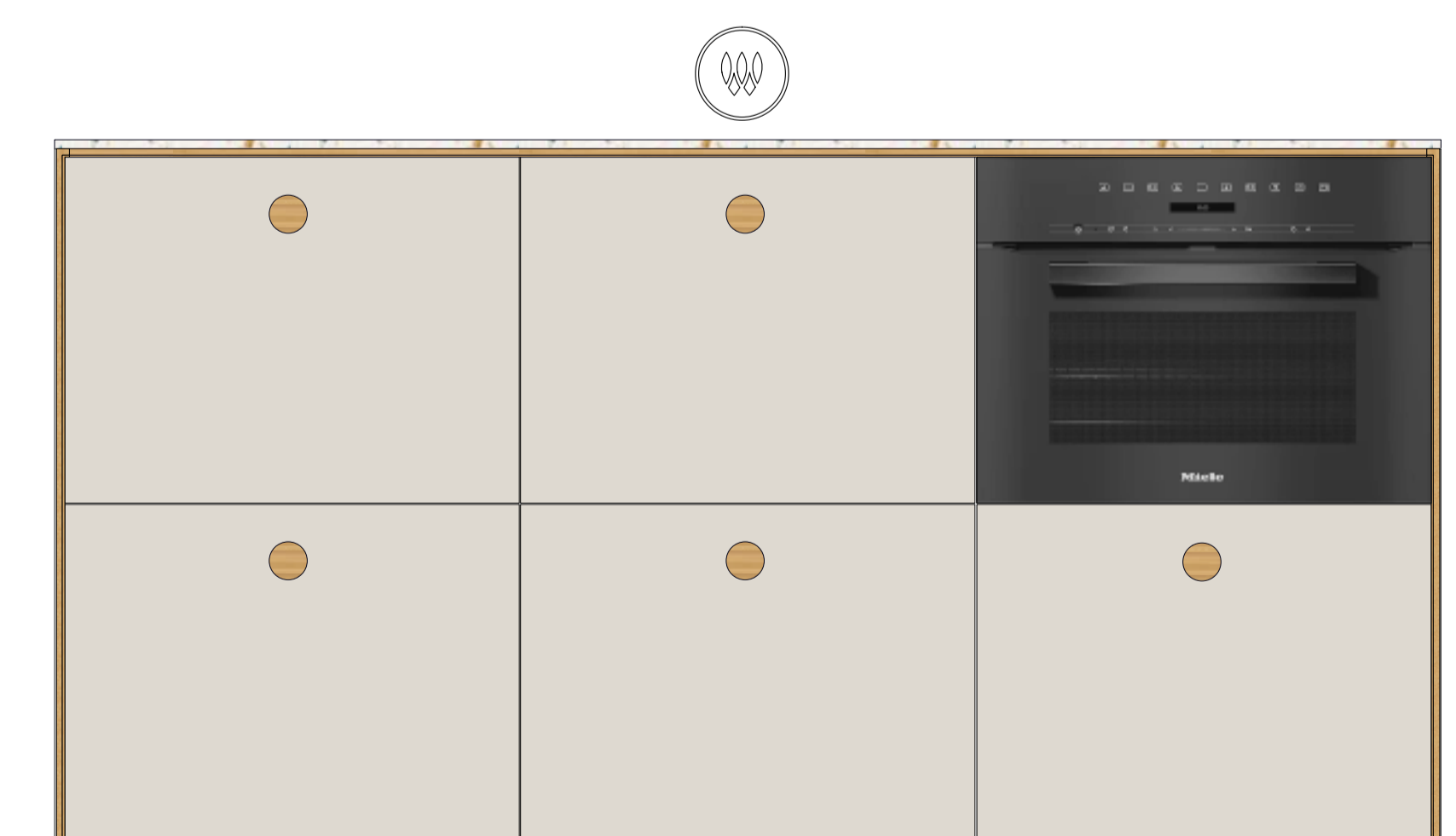

Base Unit 029

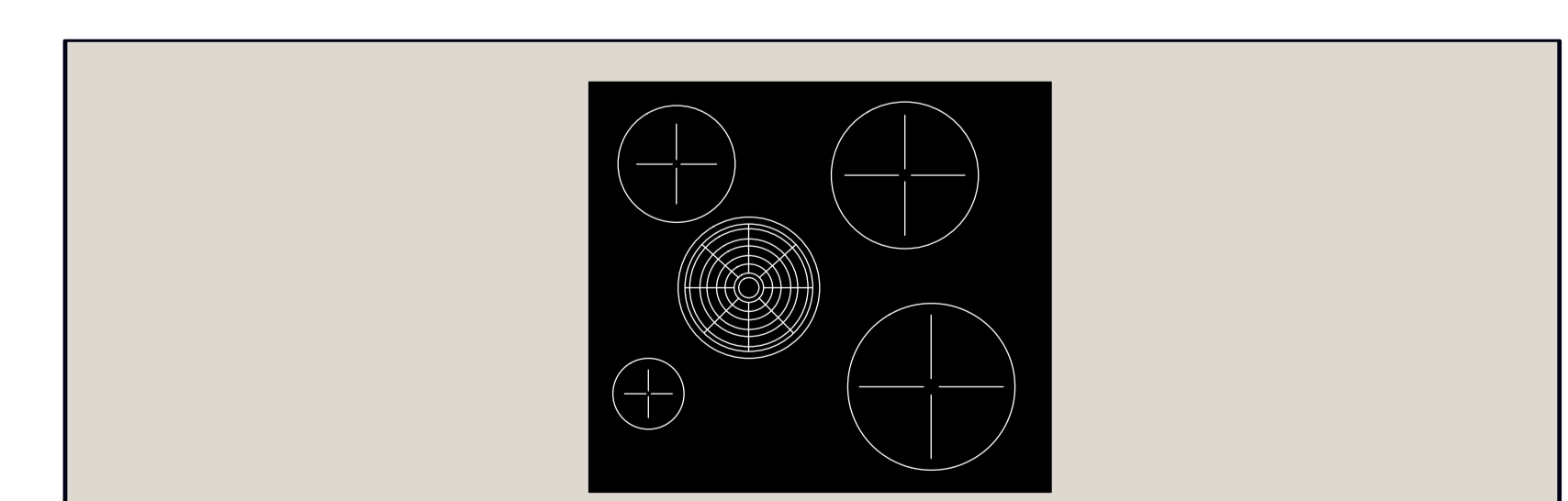
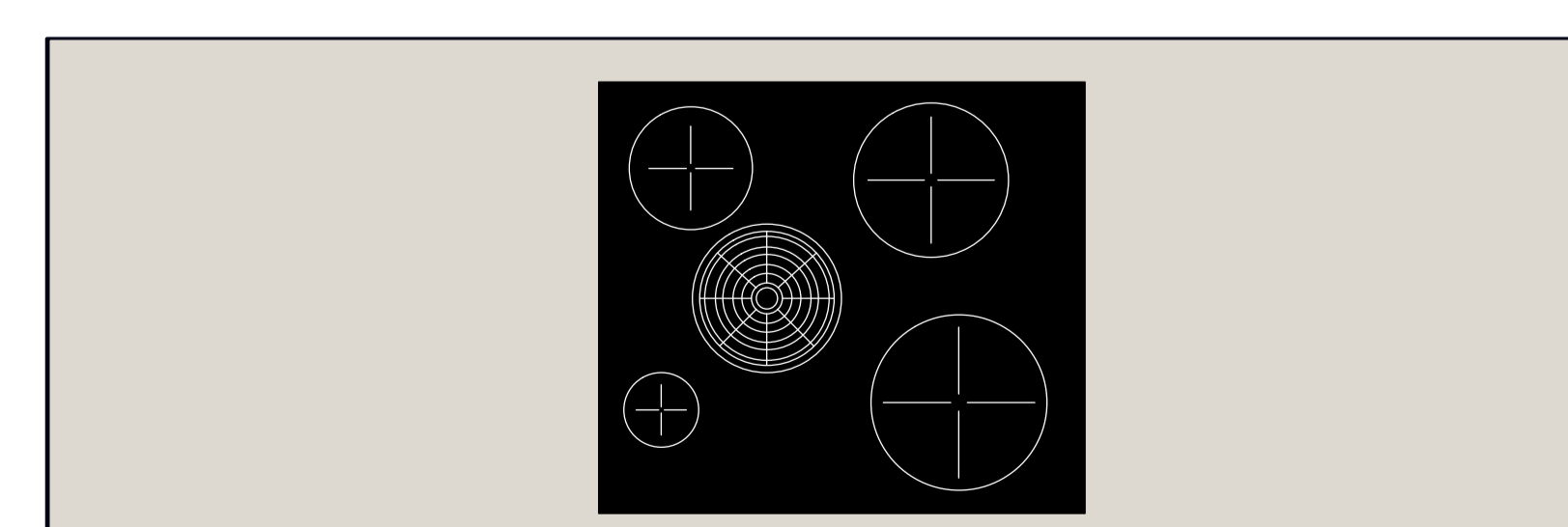
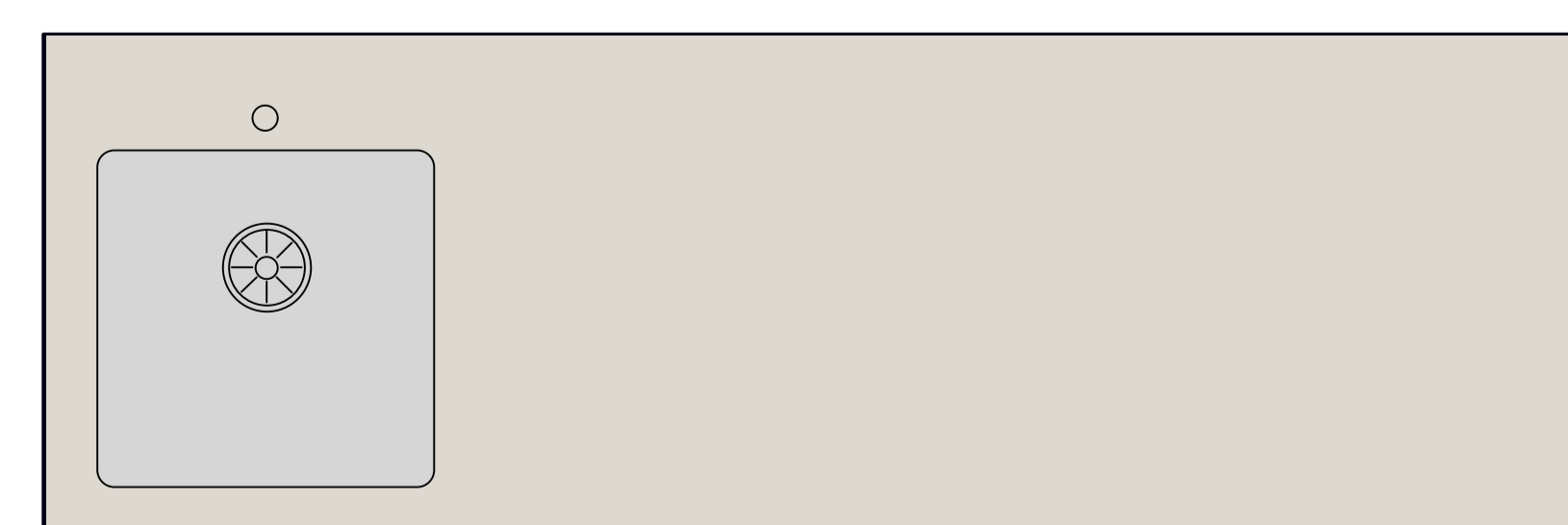

HOCHSCHRÄNKE +++ TALL UNITS

TINY KITCHEN «OFFICE»2024 **neuvermoebelt**®

Legende:  Kochfeld mit Abzug,  Geschirrspüler,  Mülltrennsystem,  Kühlschrank,  Backofen,  Weinkühlchrank,

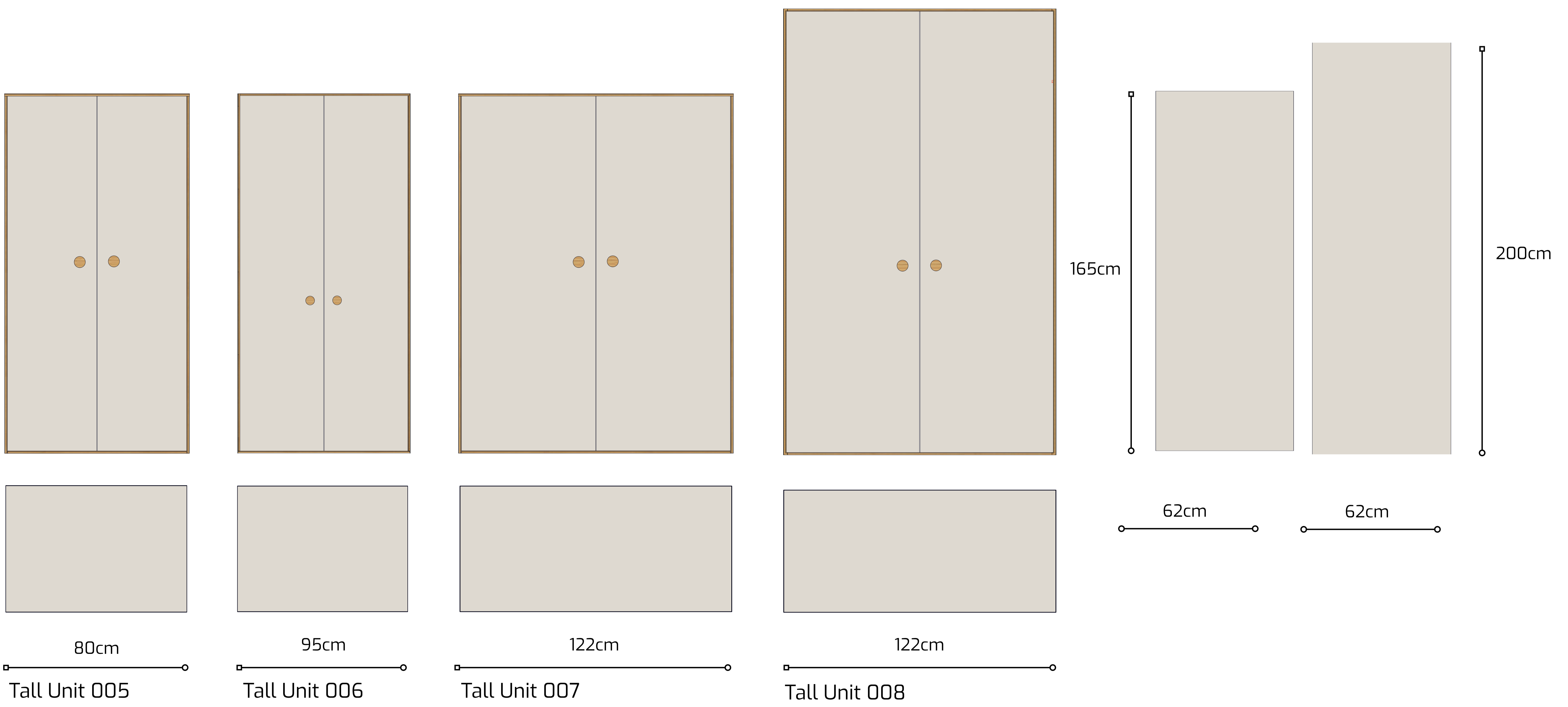
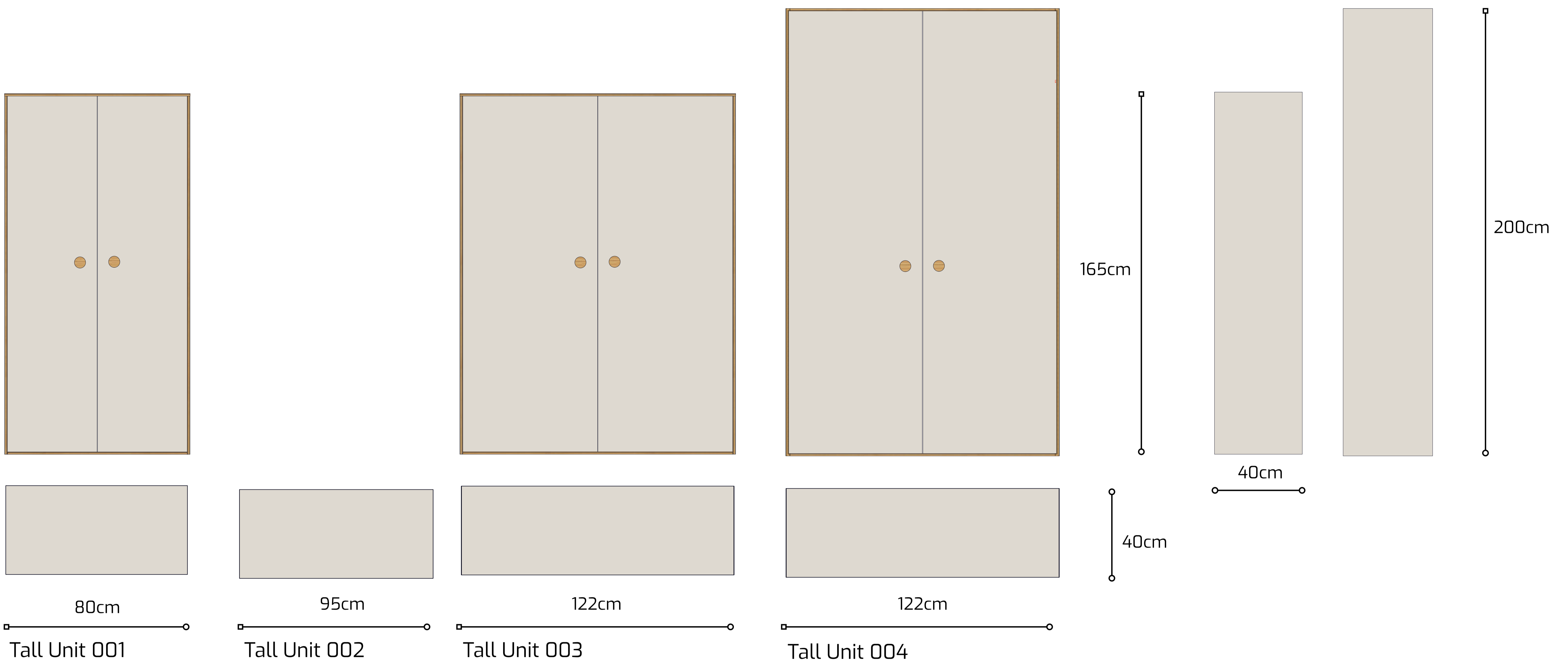

HOCHSCHRÄNKE +++ TALL UNITS

TINY KITCHEN «OFFICE»2024 **neuvermoebelt**®

Legende:  Kochfeld mit Abzug,  Geschirrspüler,  Mülltrennsystem,  Kühlschrank,  Backofen,  Weinkühlchrank,

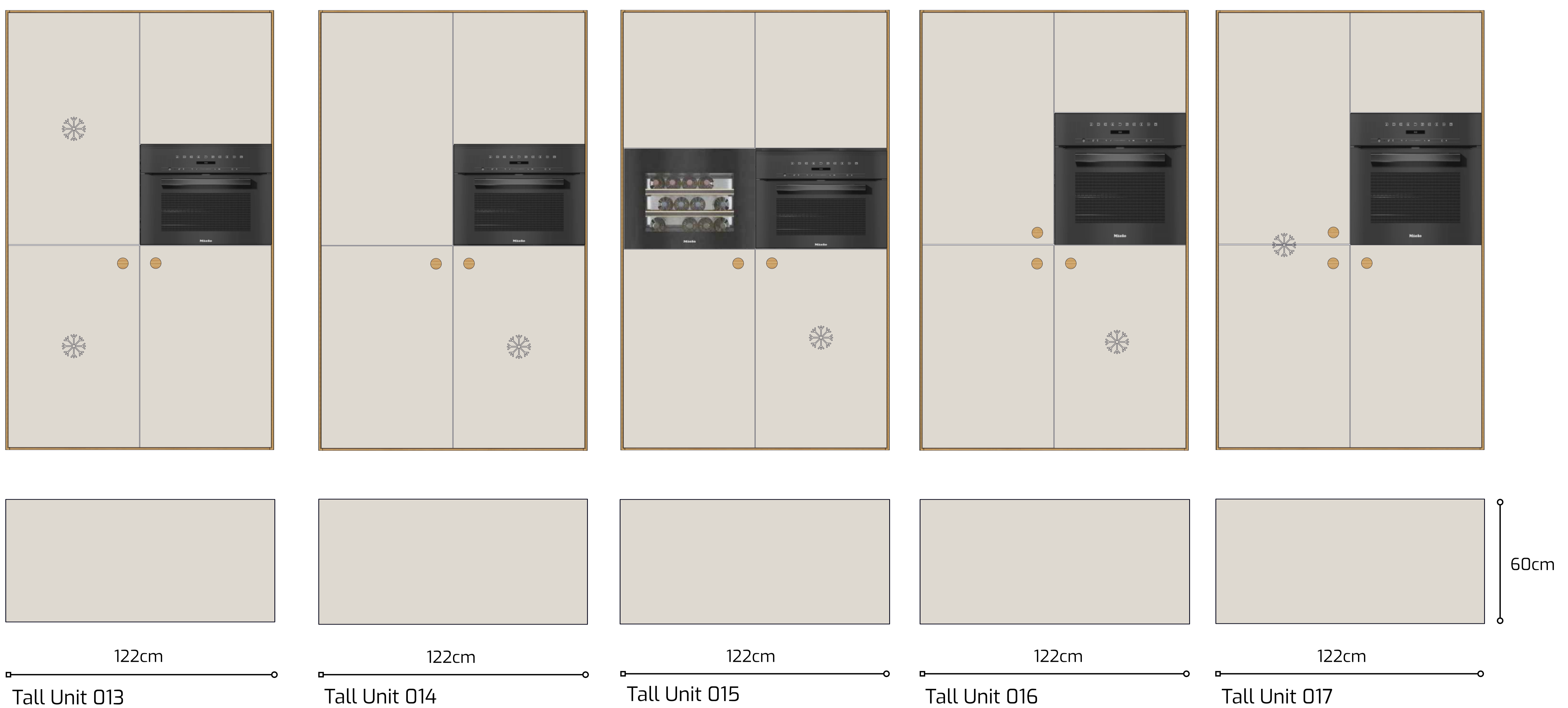
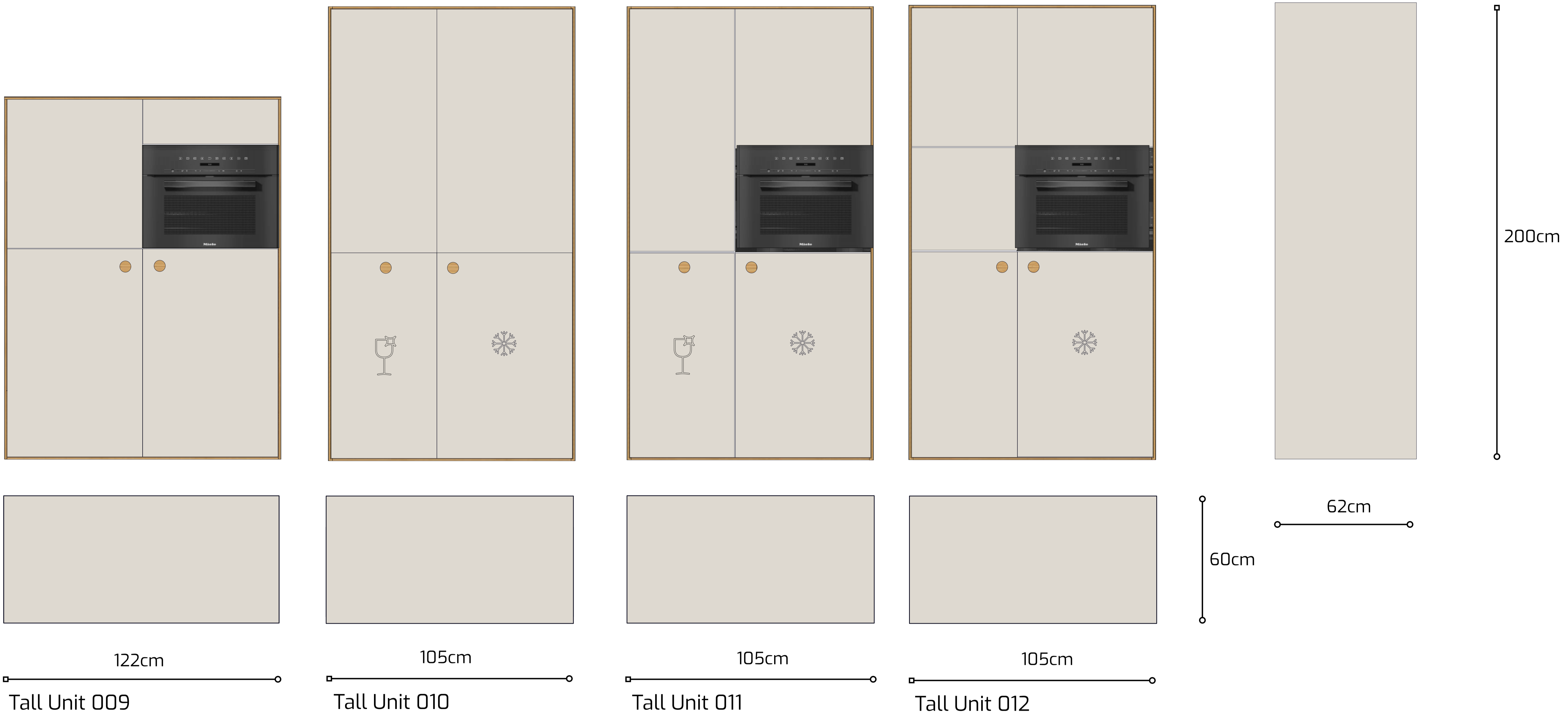

UNIT KOMBINATIONEN +++ UNIT COMBINATIONS

Legende:  Kochfeld mit Abzug,  Geschirrspüler,  Mülltrennsystem,  Kühlschrank,  Backofen,  Weinkühlchrank,

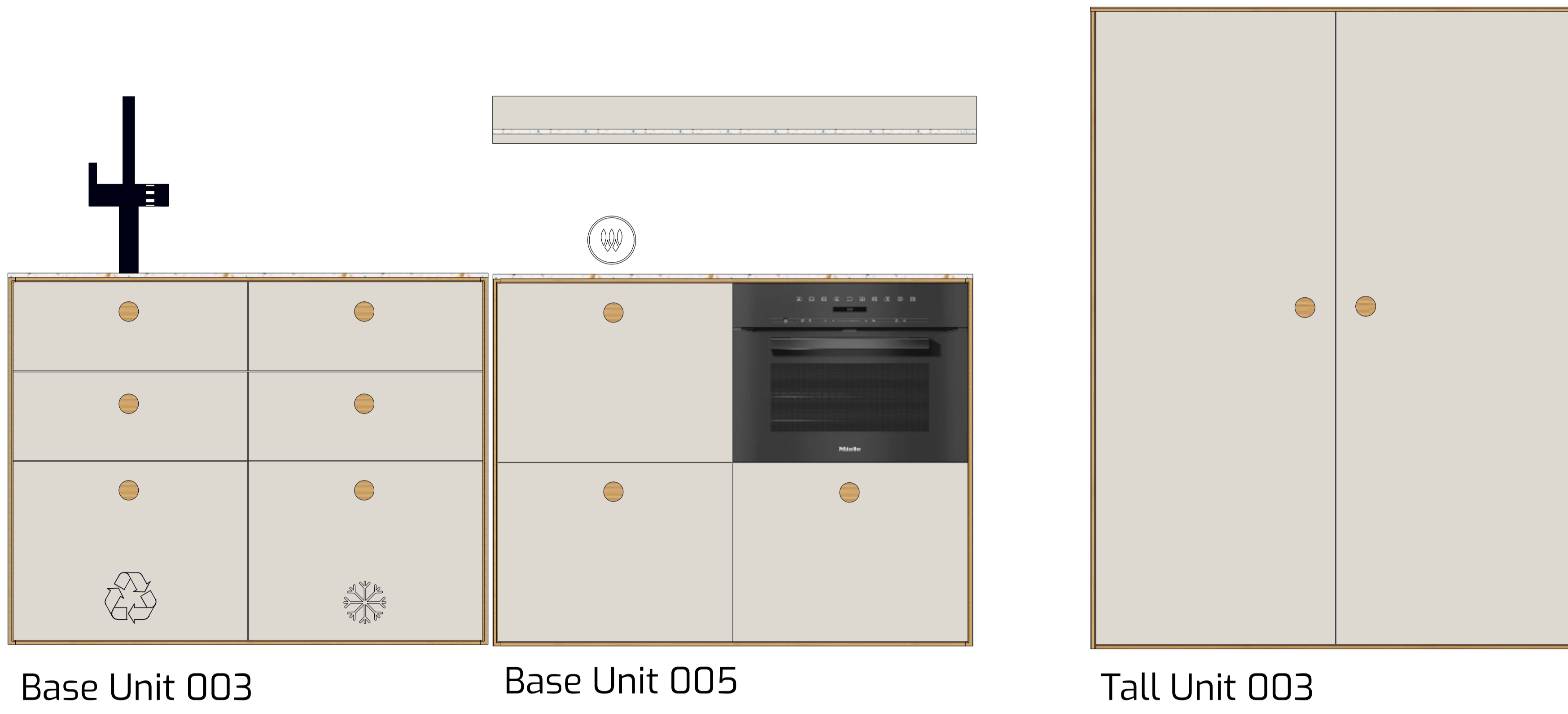

Base Unit 003

Base Unit 005

Tall Unit 003

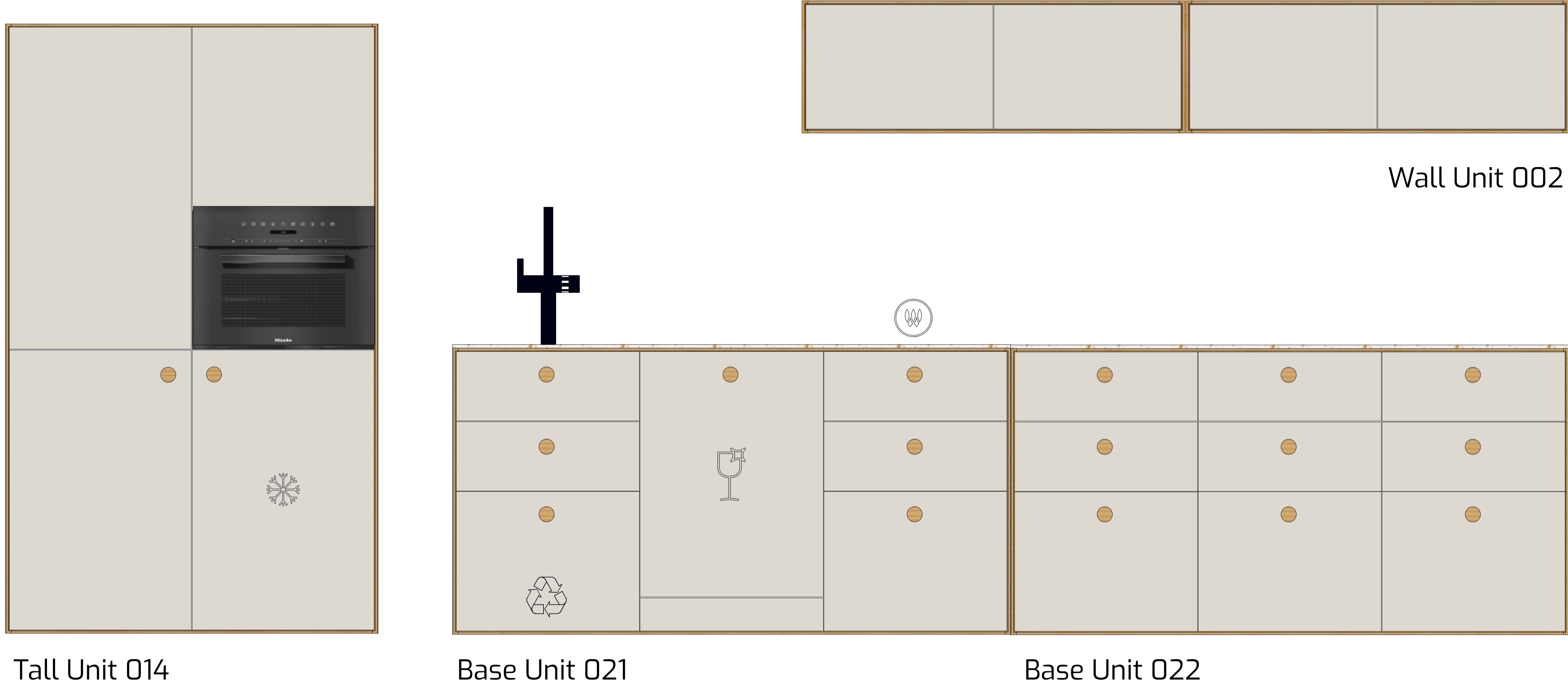

Tall Unit 014

Base Unit 021

Base Unit 022

Wall Unit 002

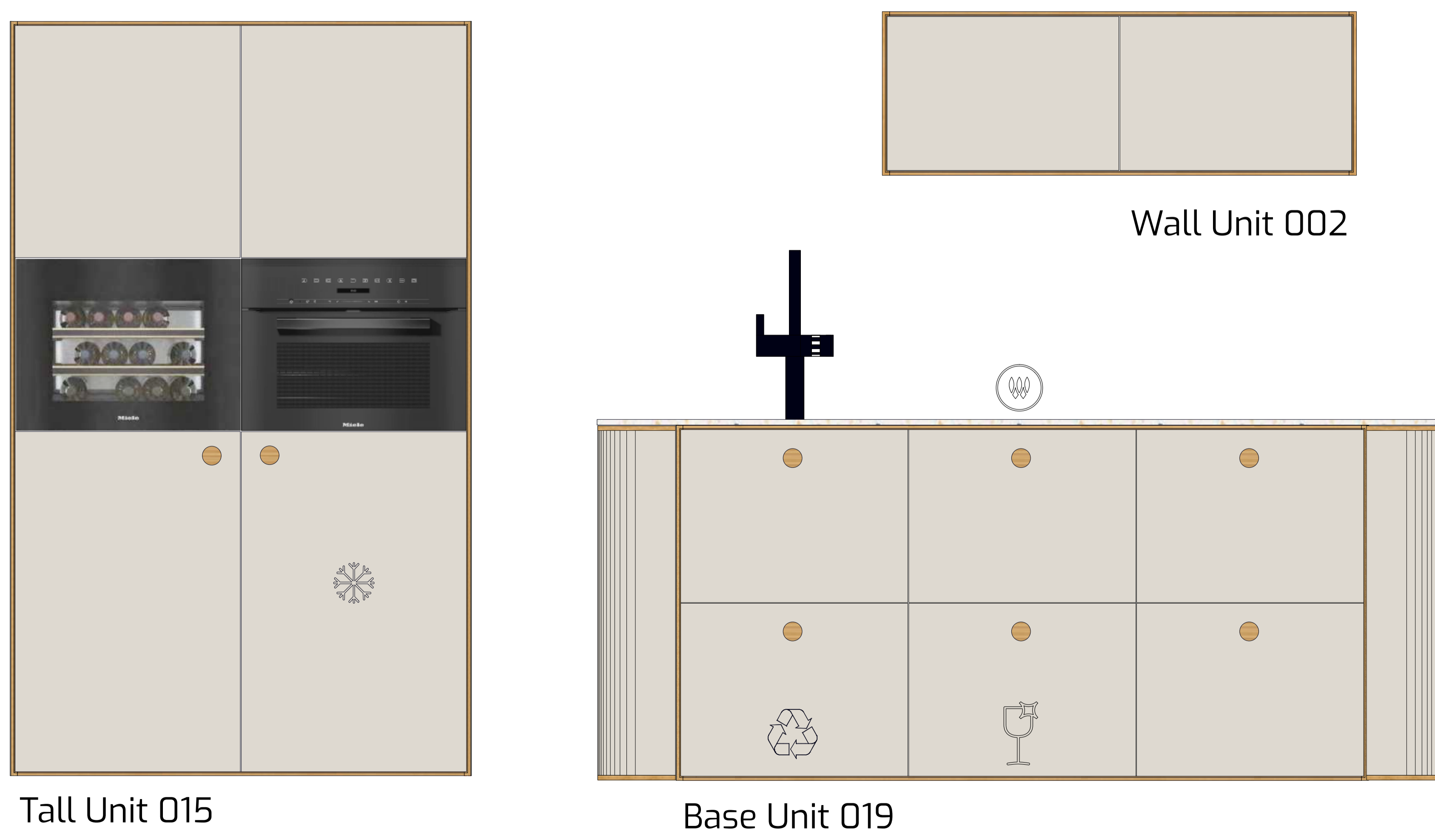

Tall Unit 015

Base Unit 019

Wall Unit 002

KOMBINATIONEN +++ COMBINATIONS

TINY KITCHEN «OFFICE»2024 **neuvermoebelt**®

Legende:  Kochfeld mit Abzug,  Geschirrspüler,  Mülltrennsystem,  Kühlschrank,  Backofen,  Weinkühlchrank,

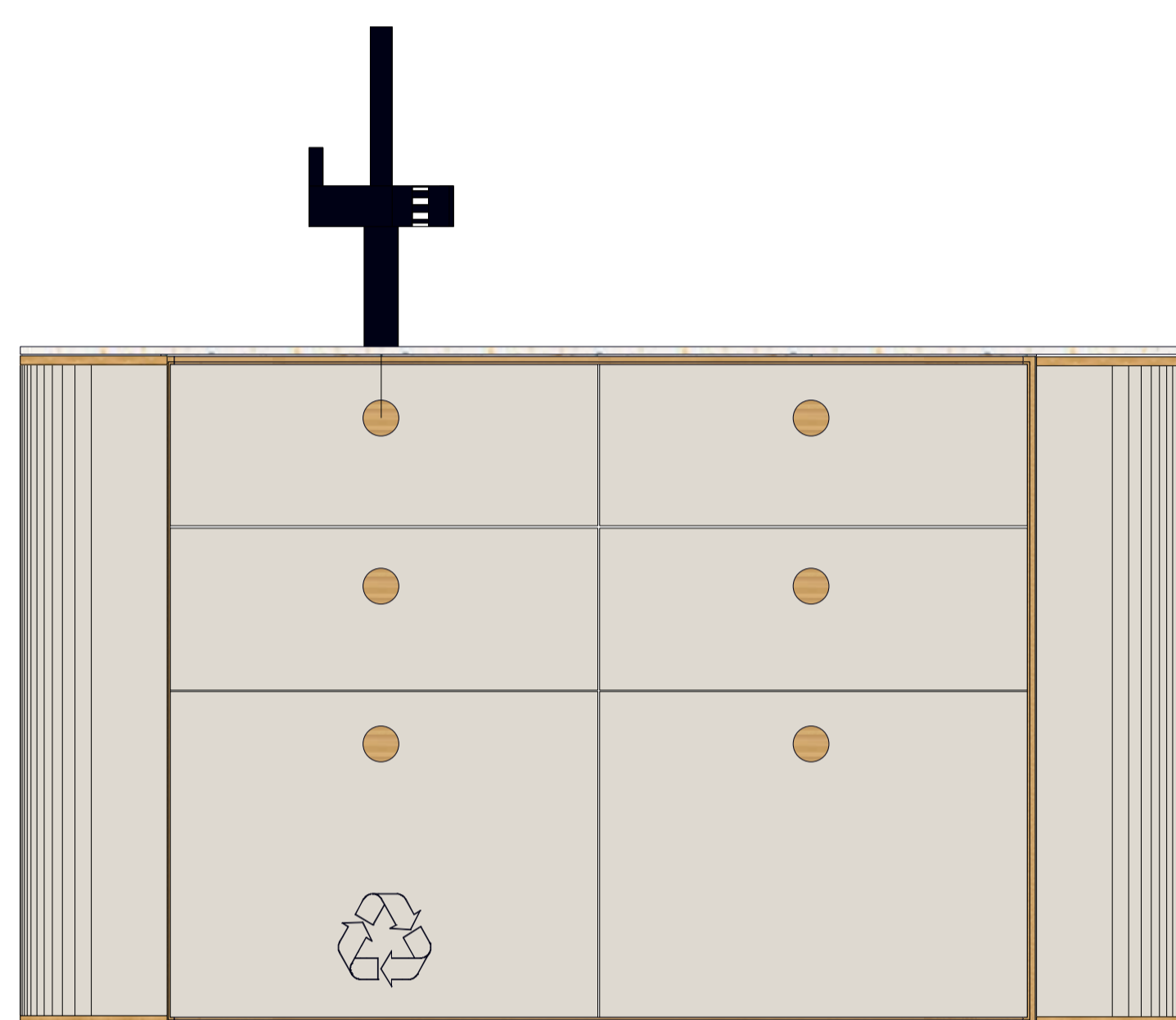

Corner Unit left Corner Unit right
Base Unit 007



Corner Unit left Corner Unit right
Base Unit 005

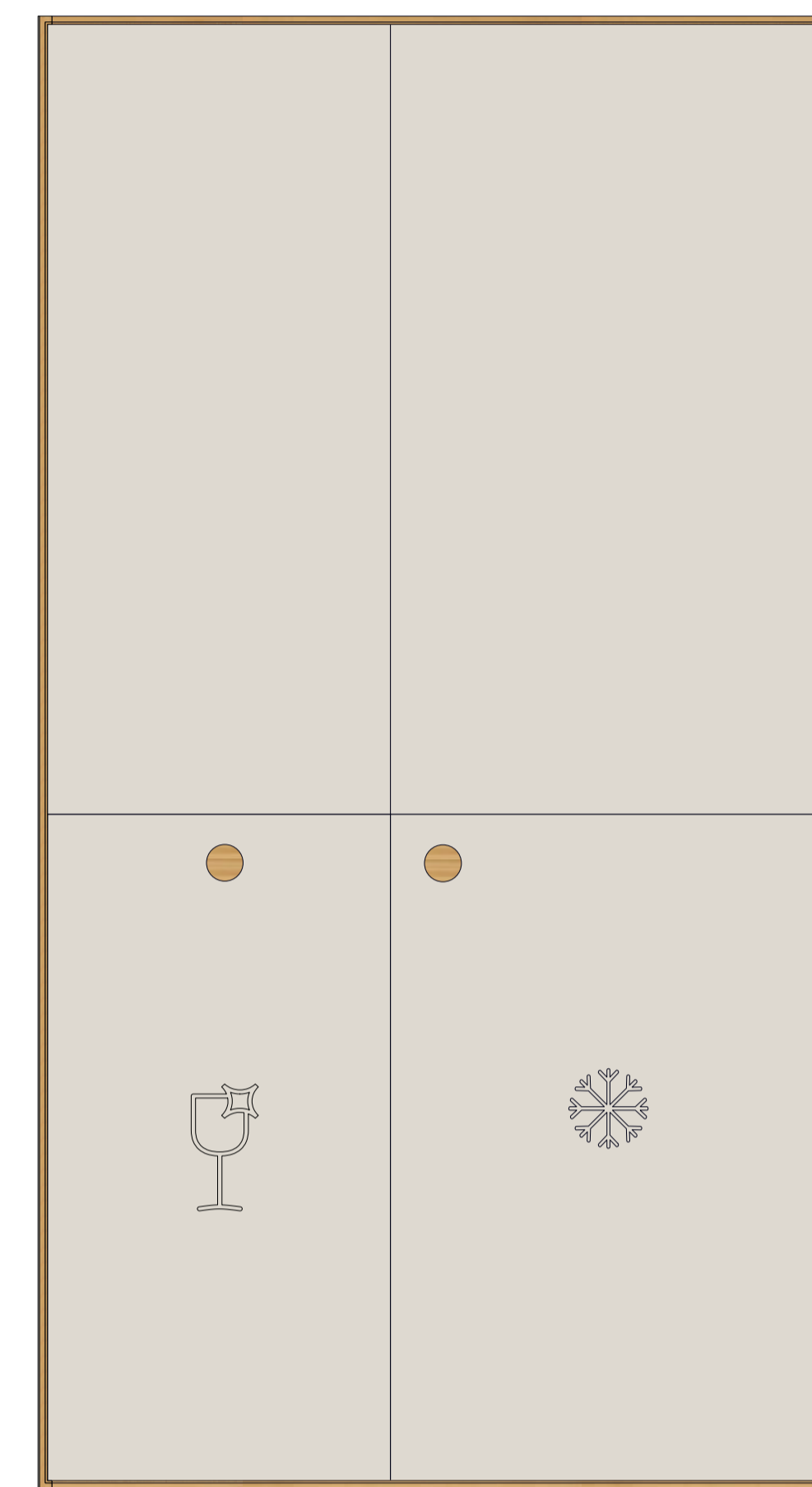

Tall Unit 010



Tall Unit 013



Wall Unit 002



Base Unit 008

Base Unit 009

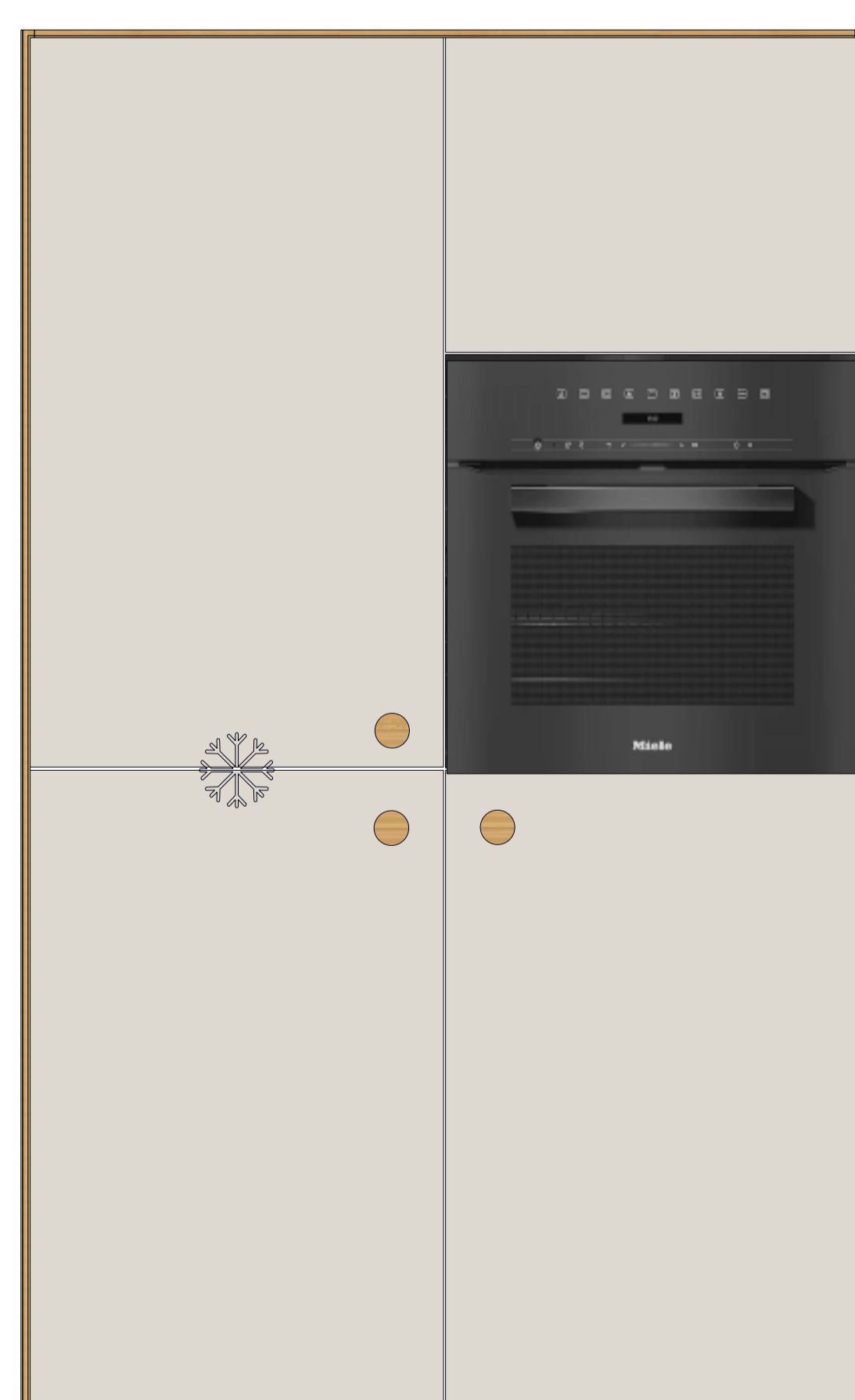

Tall Unit 017

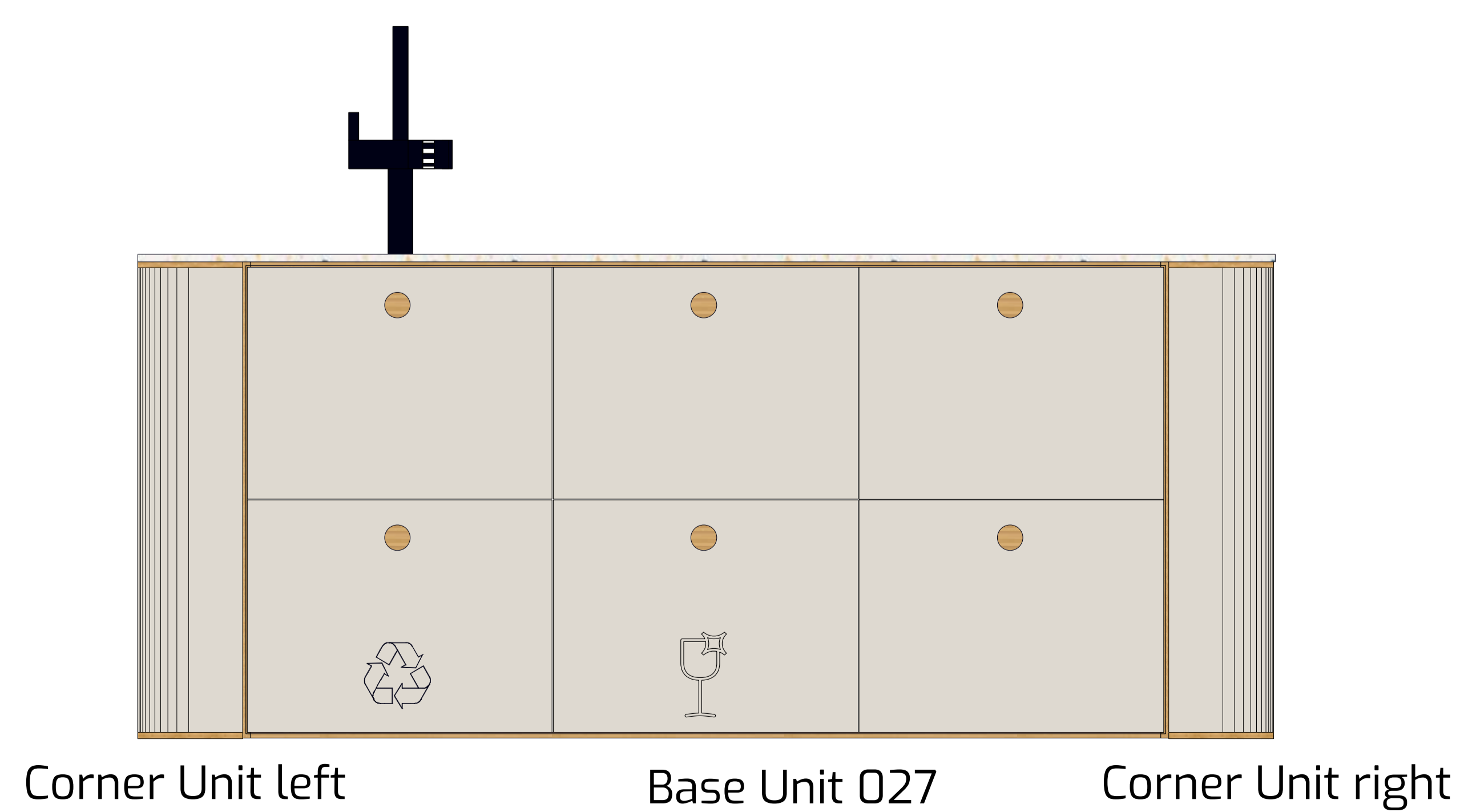

Corner Unit left

Base Unit 027

Corner Unit right

SHELFS & BACKWALLS

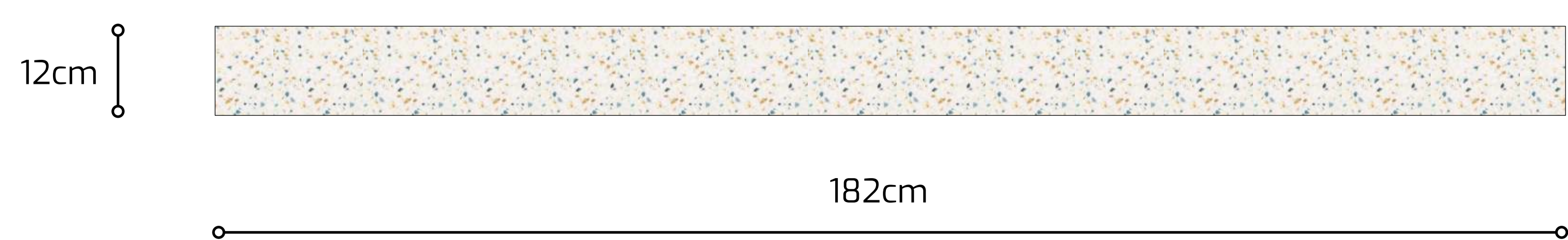
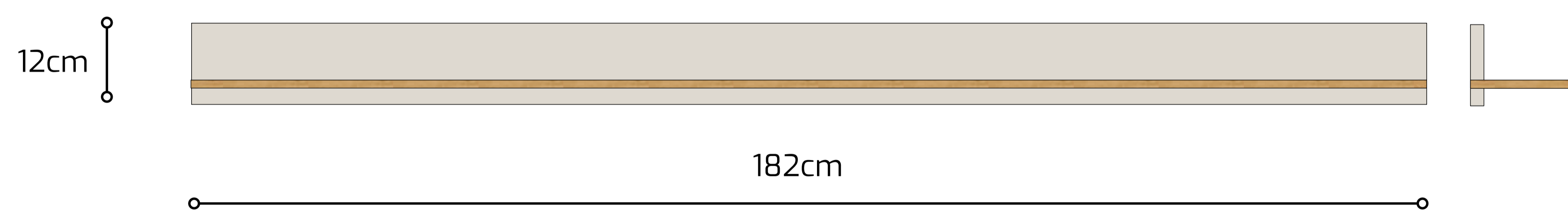
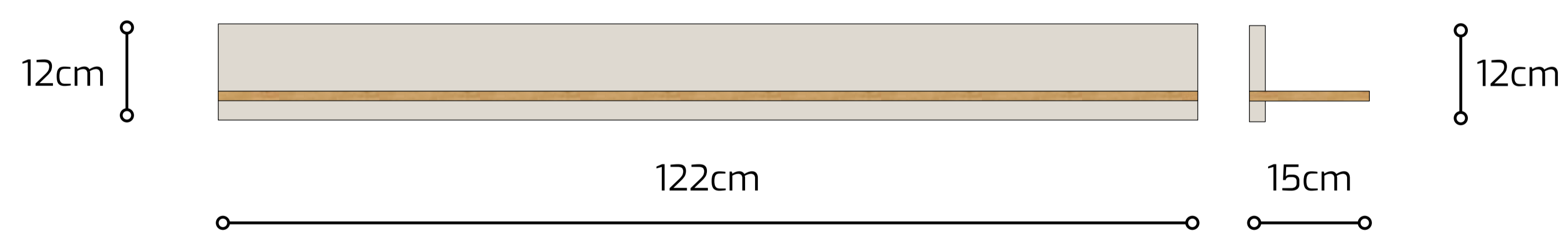
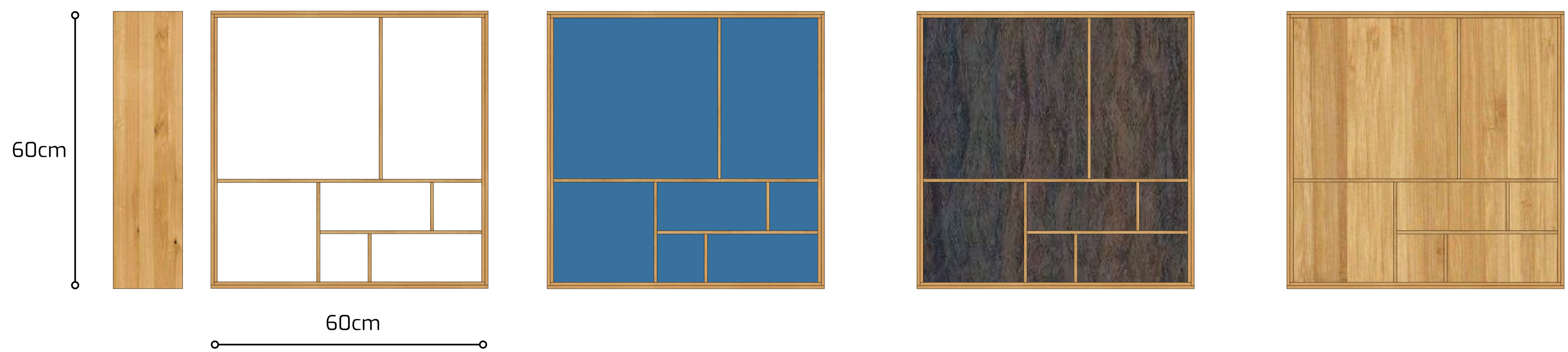

CUPBOARDS

TINY KITCHEN «OFFICE» 2024 **neuvermoebelt**®

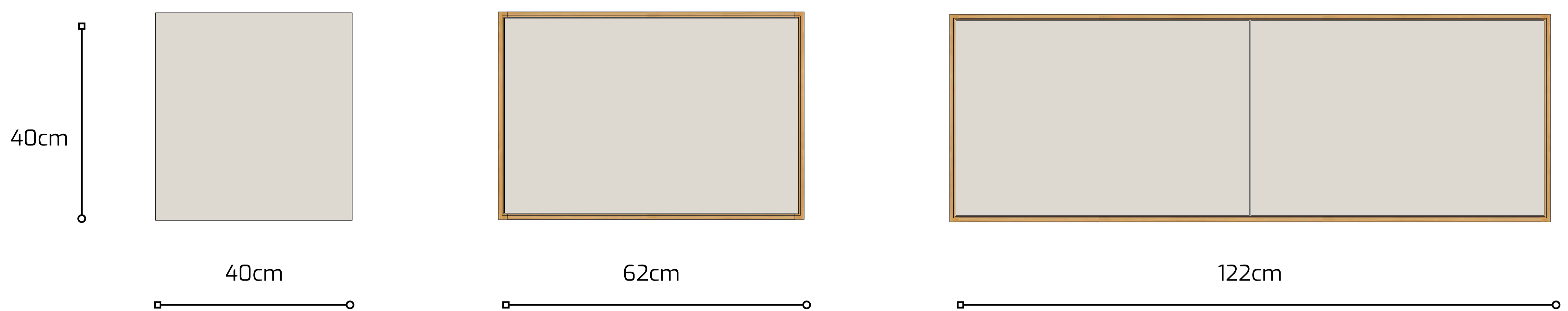

Wall Unit 001

Wall Unit 002

Corner Unit left + right

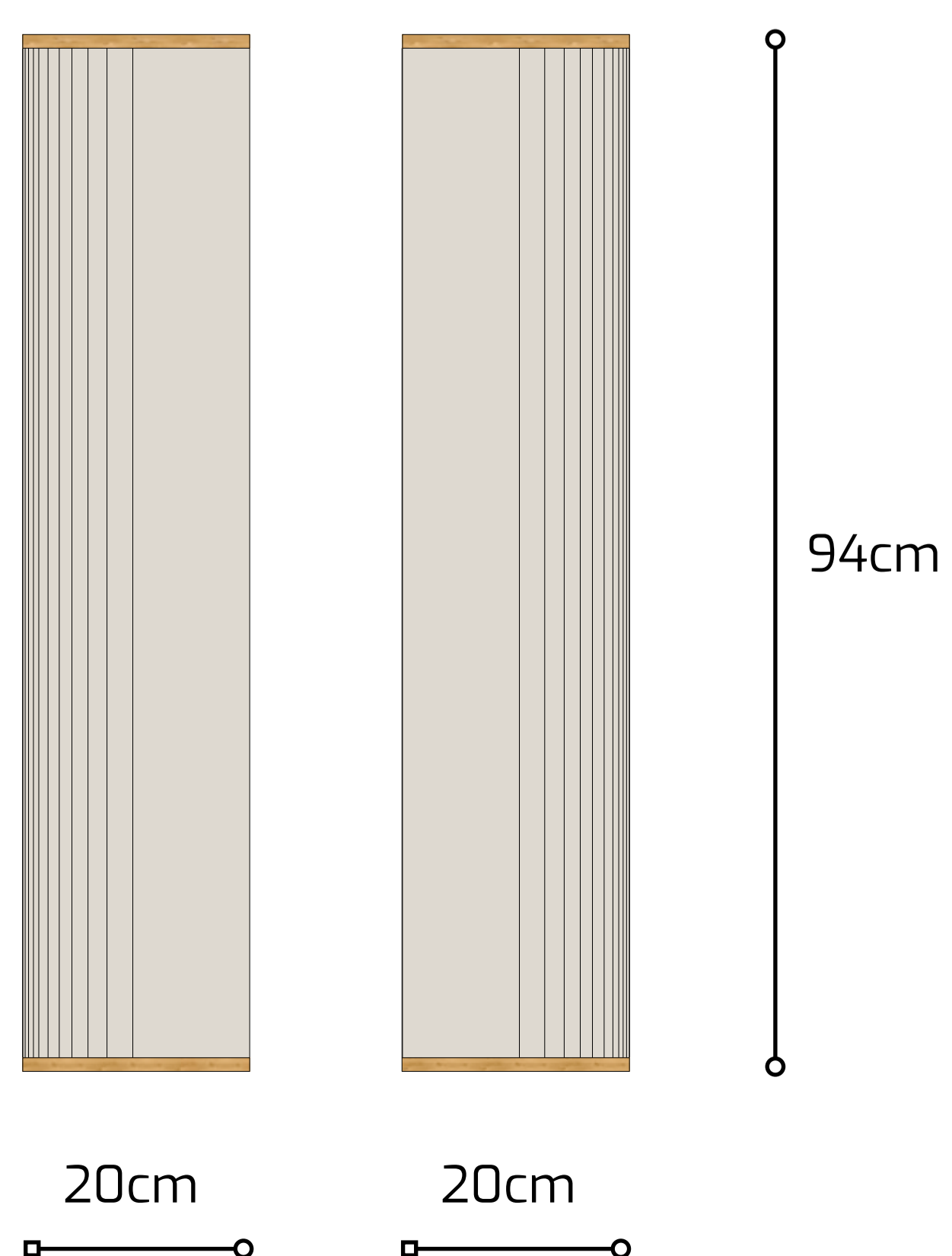

Wall Unit 003

SCHUBLADEN +++ DRAWERS

TINY KITCHEN «OFFICE»2024 **neuvermoebelt®**

BAMBUS, WALNUSS, RÄUCHEREICHE +++ BAMBOO, WALNUT, SMOKED OAK



INNENSCHUBLADE
HOCH
+++
INNER DRAWER HIGH



INNENSCHUBLADE
HOCH
+++
INNER DRAWER HIGH



INNENSCHUBLADE
MITTEL
+++
INNER DRAWER MEDIUM



INNENSCHUBLADE
MITTEL
+++
INNER DRAWER MEDIUM



INNENSCHUBLADE
NIEDRIG
+++
INNER DRAWER LOW



INNENSCHUBLADE
HOCH
+++
INNER DRAWER LOW



INNENSCHUBLADE
HOCH
+++
INNER DRAWER LOW



INNENSCHUBLADE
MITTEL
+++
INNER DRAWER MEDIUM



GLAS INNENSCHUBLADE
NIEDRIG
+++
GLAS INNER DRAWER LOW

NUR IN WALNUSS, RÄUCHEREICHE ERHÄLTlich
ONLY AVAILABLE IN WALNUT, SMOKED OAK



GLAS INNENSCHUBLADE
MITTEL
+++
GLASS INNER DRAWER

NUR IN WALNUSS, RÄUCHEREICHE ERHÄLTlich
ONLY AVAILABLE IN WALNUT, SMOKED OAK



SYPHON SCHUBLADE
NIEDRIG
+++
SIPHON DRAWER LOW

SCHUBLADENEINTICHTUNG +++ DRAWER INSERT

Yellow = * VARIABEL ++

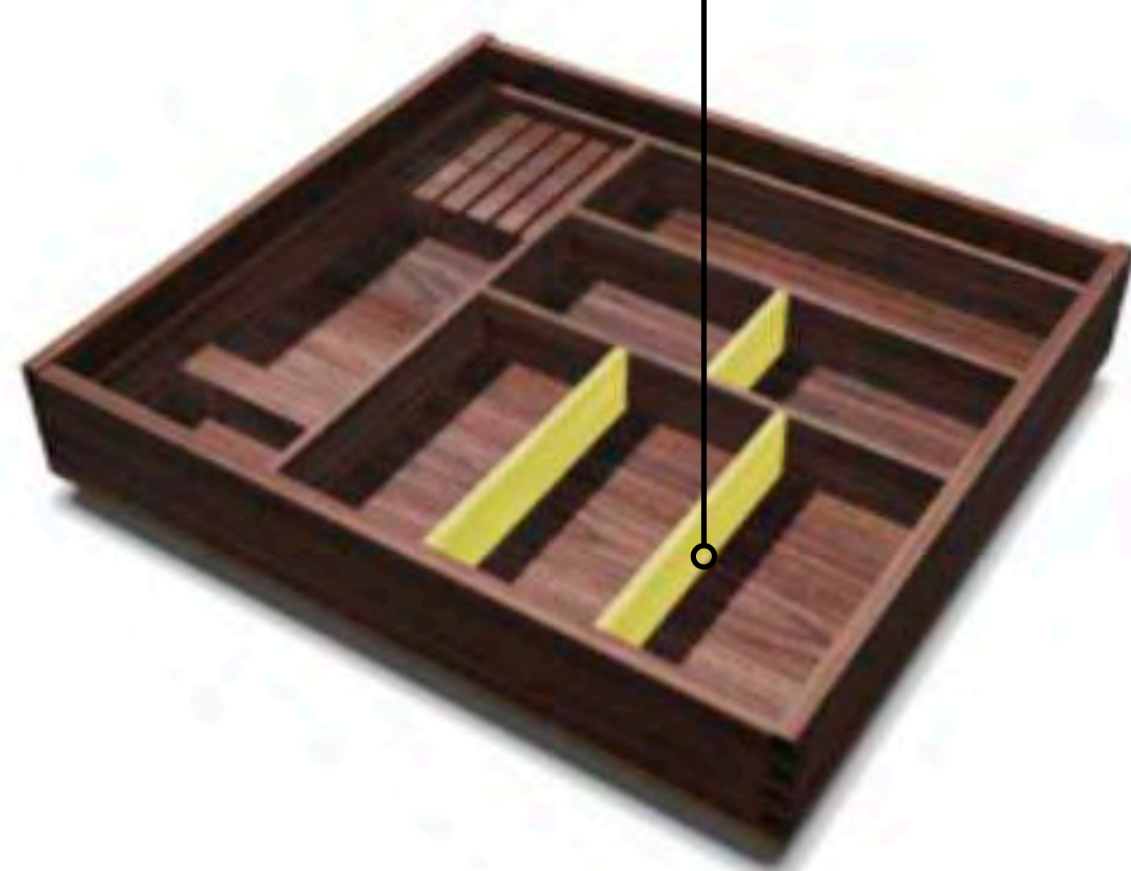

INNENSCHUBLADE
HOCH
+++
INNER DRAWER HIGH



INNENSCHUBLADE
HOCH
+++
INNER DRAWER HIGH



GEWÜRZ SCHUBLADE
MITTEL
+++
SPICE DRAWER MEDIUM



GEWÜRZGLÄSE
R
+++
SPICE GLASSES

ZUSATZARTIKEL +++ ADDITIONALS

TINY KITCHEN «OFFICE»2024 **neuvermoebelt**[®]



BILLUND, 12cm Duo
GEWÜRZMÜHLE
+++
SPICE GRINDERS



BILLUND, LAVENDEL 12cm
GEWÜRZMÜHLE
+++
SPICE GRINDERS



BILLUND, MASALA 12cm
GEWÜRZMÜHLE
+++
SPICE GRINDERS



BILLUND, BEETROOT 12cm
GEWÜRZMÜHLE
+++
SPICE GRINDERS



BLUEBEERY 12cm Duo
GEWÜRZMÜHLE
+++
SPICE GRINDERS



PAPRIKA 12cm Duo
GEWÜRZMÜHLE
+++
SPICE GRINDERS



Schneidbrett 400
BAMBUS
+++
Cutting board 400
BAMBOO

SHELFS & BACKWALLS

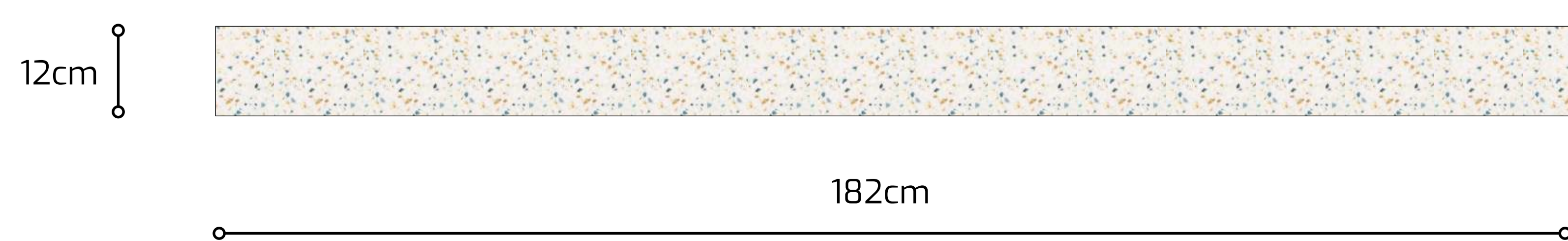
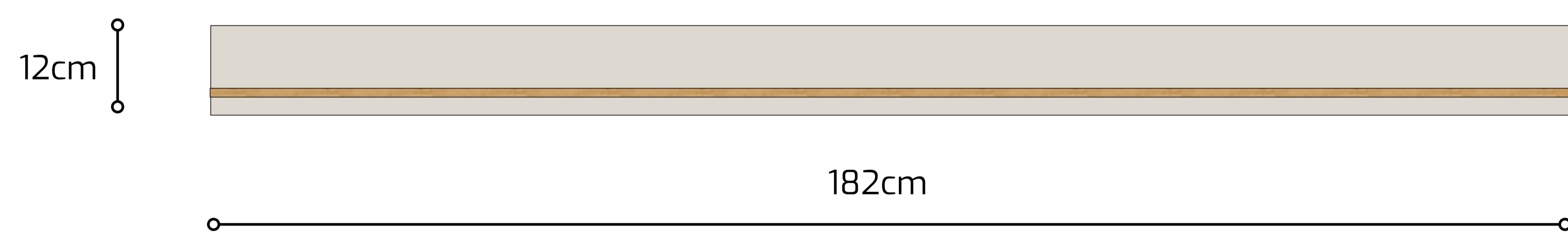
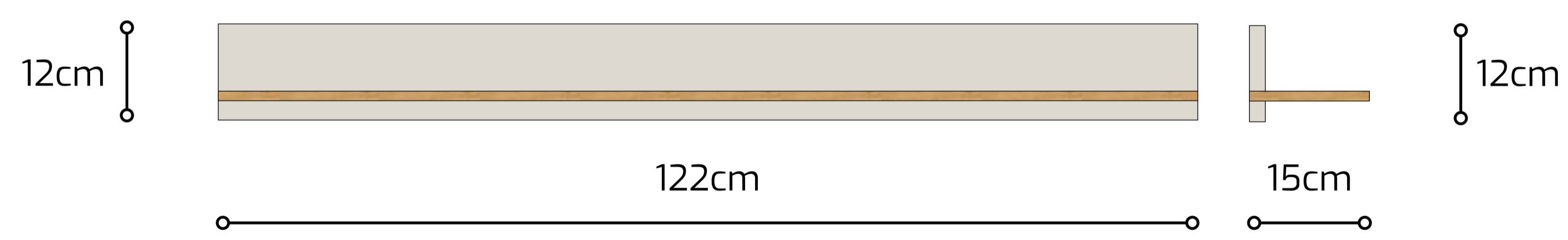
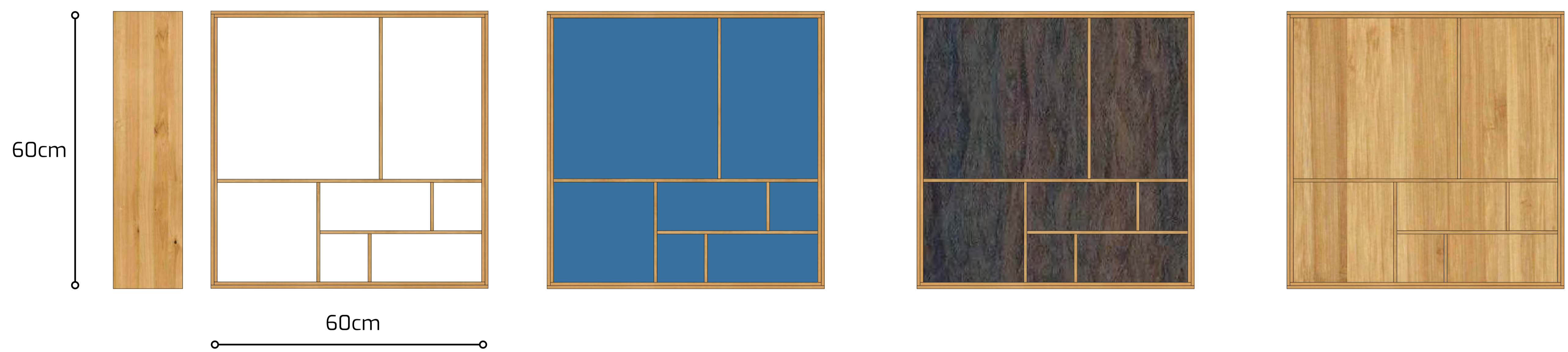

CUPBOARDS

TINY KITCHEN «OFFICE» 2024 **neuvermoebelt**®

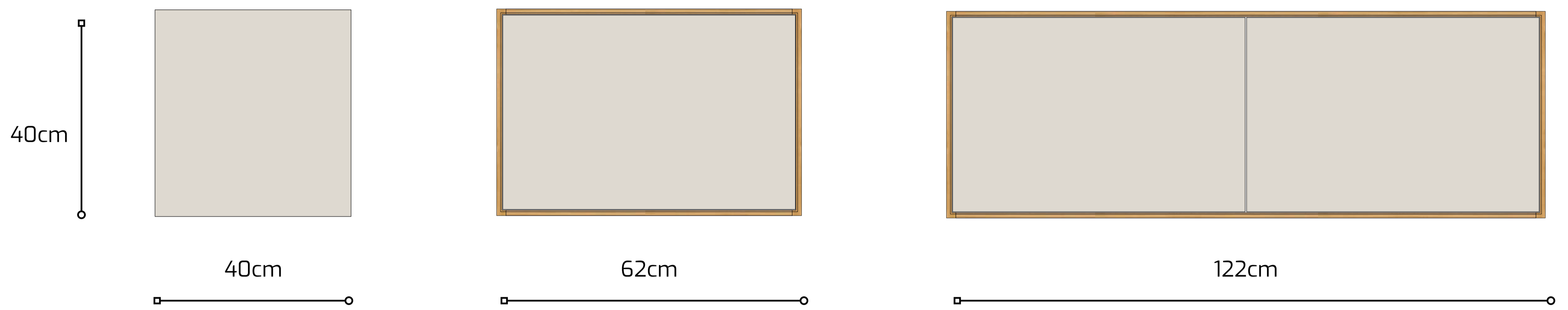

Wall Unit 001

Wall Unit 002

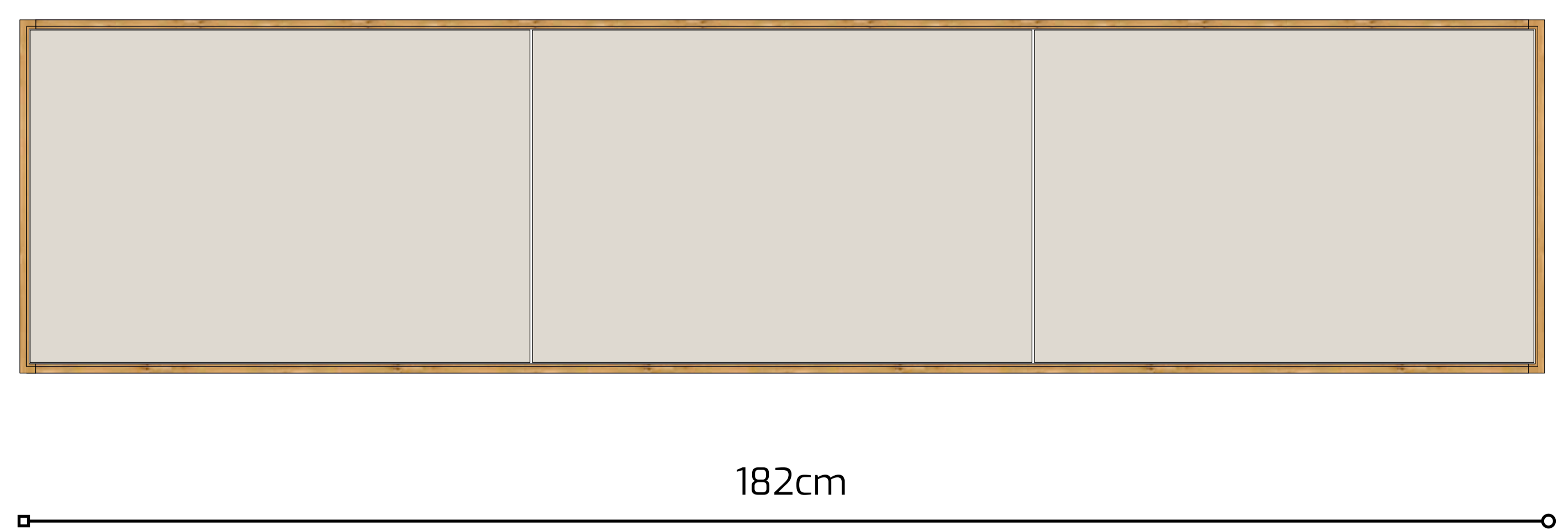

Wall Unit 003

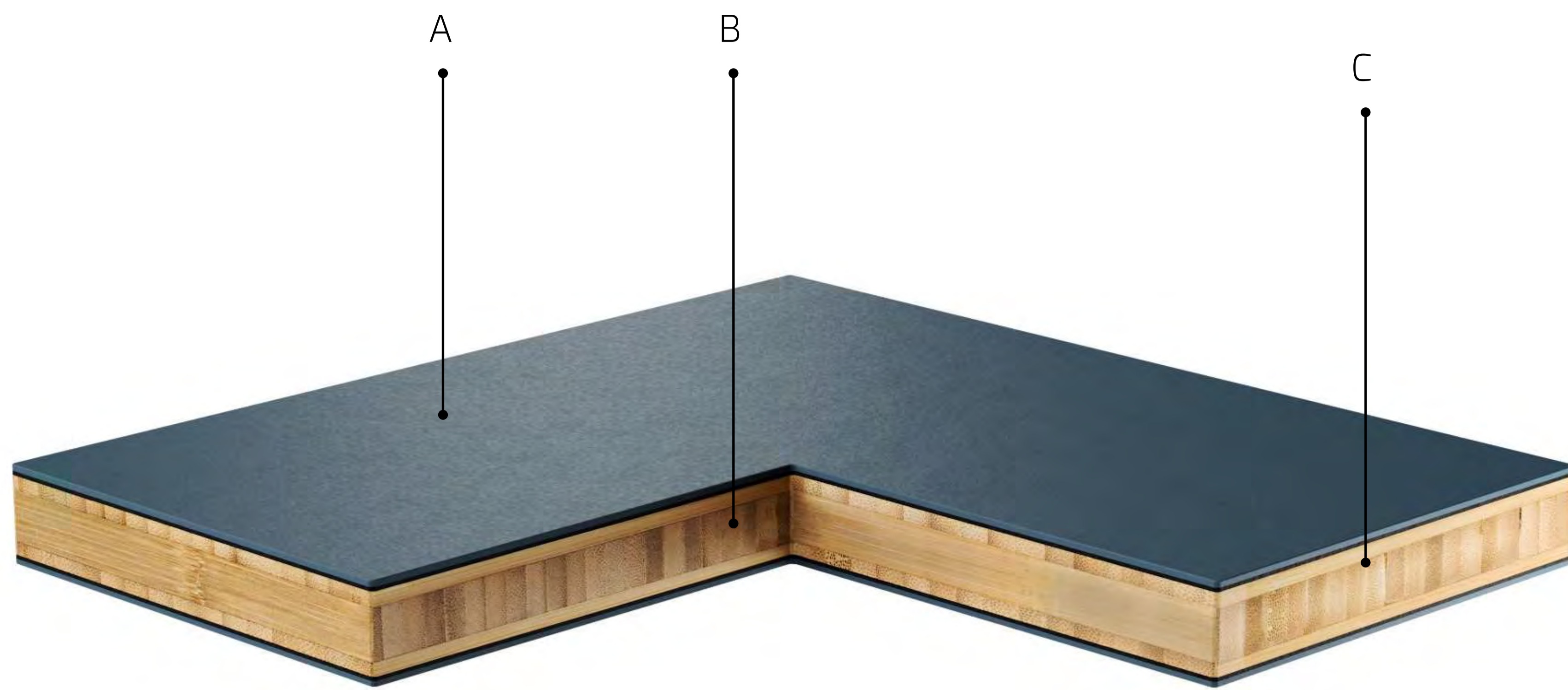

A = Front = 2mm Forbo Desktop Linoleum
 B = Kern = Bambus 3 Schichtplatte 16mm
 C= Kante = Bambus 3 Schichtplatte geölt
 D = Rückseite 2mm Linoleum

A = Front = 2mm Forbo Desktop Linoleum
 B = Core = Bamboo 3 ply board 16mm
 C= Edge = Bamboo 3-layer board oiled
 D = Back side 2mm Linoleum

PFLEGE UND WARTUNG

Die Linoleumfronten können mit einem weichen, in warmem Wasser angefeuchteten Tuch und einem milden Haushaltsreiniger gereinigt werden. Anschließend mit einem trockenen, weichen Tuch nachreiben.

Wir empfehlen unsere auf die Oberflächen abgestimmten Pflegemittel.

CARE AND MAINTENANCE

The linoleum fronts can be cleaned with a soft cloth dampened in warm water and a mild household cleaner. Wipe with a dry, soft cloth.

We recommend using our surface care products.



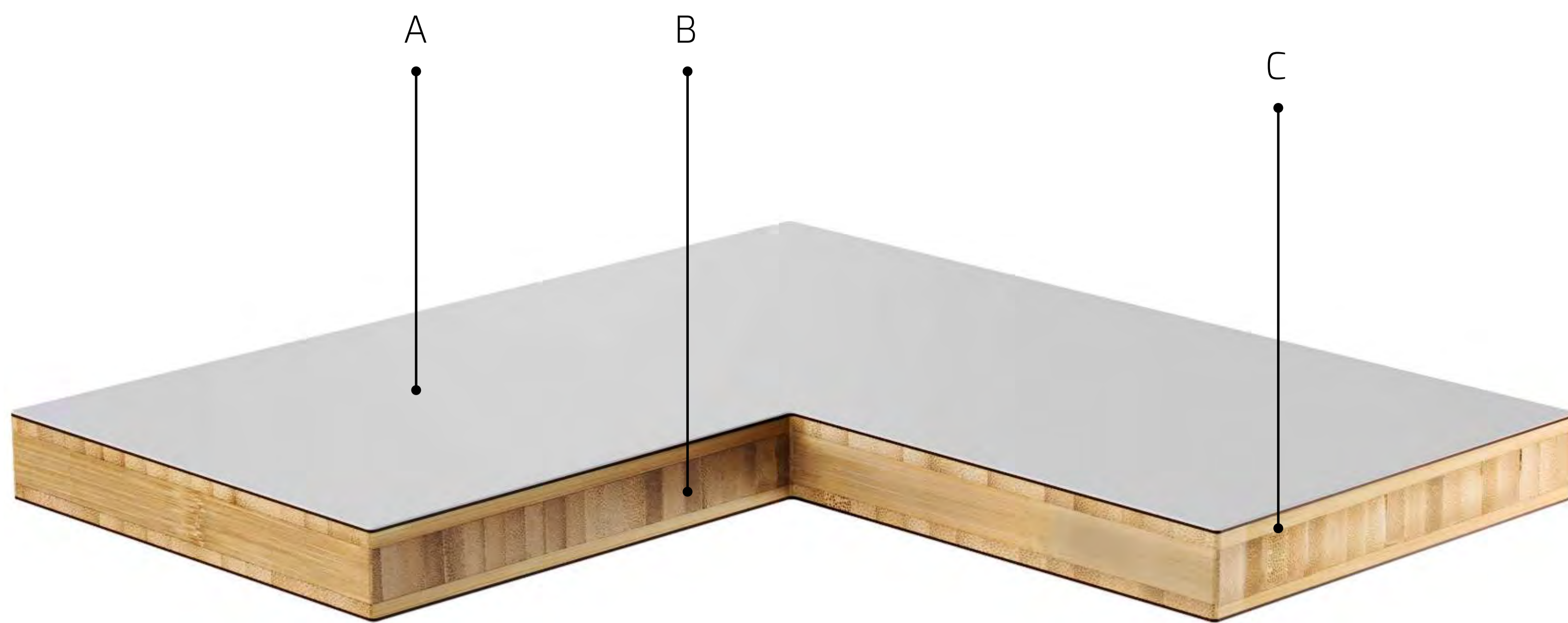

A = Front = 0,8mm Fenix® NTM
 B = Kern = Bambus 3 Schichtplatte 16mm
 C = Kante = Bambus 3 Schichtplatte geölt
 D = Rückseite Fenix Gegenzug

A = Front = 0,8mm Fenix® NTM
 B = Core = Bamboo 3 ply board 16mm
 C = Edge = Bamboo 3-layer board oiled
 D = Back side Fenix counter-move

PFLEGE UND WARTUNG

Die Fenix® Fronten können mit einem weichen, in warmem Wasser angefeuchteten Tuch und einem milden Haushaltsreiniger gereinigt werden. Anschließend mit einem trockenen, weichen Tuch nachreiben.

Wir empfehlen unsere auf die Oberflächen abgestimmten Pflegemittel.

CARE AND MAINTENANCE

The Fenix® fronts can be cleaned with a soft cloth dampened in warm water and a mild household cleaner. Wipe with a dry, soft cloth.

We recommend using our surface care products.

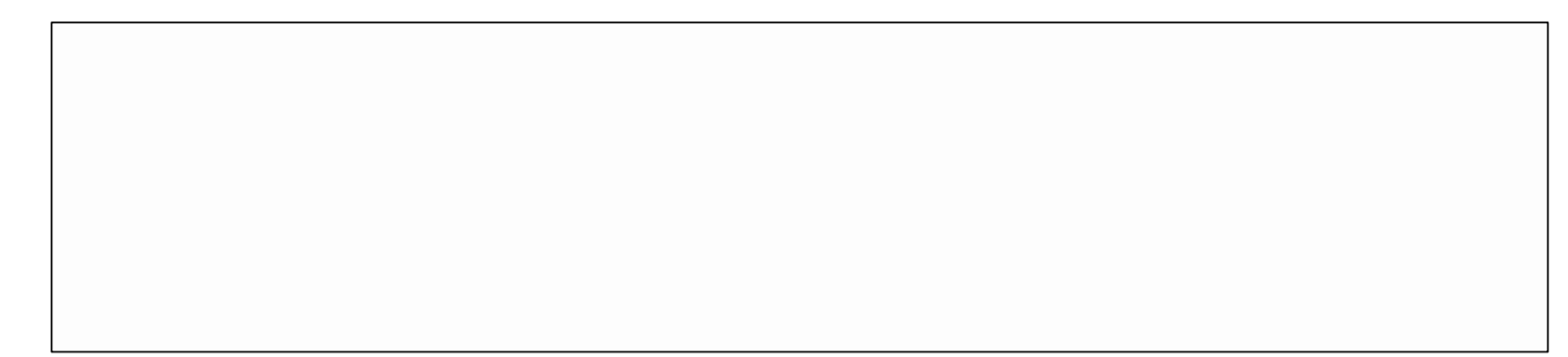

BIANCO KOS 0032



GRIGIO ANTRIM 0752



BEIGE ARIZONA 0748



CASTORO OTTAWA 0717



VERDE COMODORO 0750



BLU FES 0754



VIOLA OPRISSA 0790



GIALLO EVORA 0791



GRIGIO EFESO 0725



ROSSO NAMIB 0789



GRIGIO LONDRA 0718



GRIGIO BROMO 0724



ROSSO JAIPUR 0751



NERO INGO 0720

FRONT FACTS _ LAMINATE

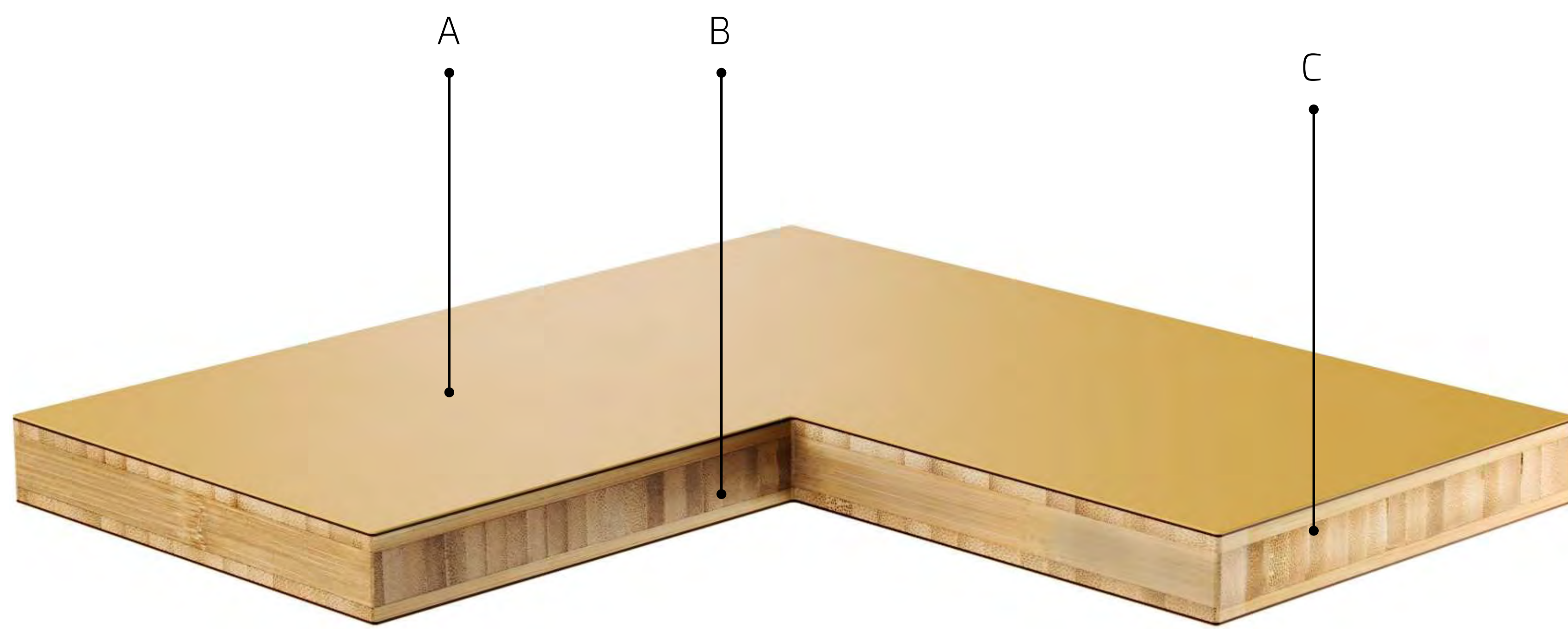

A = Front = 0,6 mm Laminat
 B = Kern = Bambus 3 Schichtplatte 16mm
 C = Kante = Bambus 3 Schichtplatte geölt
 D = Rückseite Gegenzug

A = Front = 0,6 mm Laminat
 B = Core = Bamboo 3 ply board 16mm
 C = Edge = Bamboo 3-layer board oiled
 D = Back side Laminat counter-move

PFLEGE UND WARTUNG

Die Laminat Fronten können mit einem weichen, in warmem Wasser angefeuchteten Tuch und einem milden Haushaltsreiniger gereinigt werden. Anschließend mit einem trockenen, weichen Tuch nachreiben.

Wir empfehlen unsere auf die Oberflächen abgestimmten Pflegemittel.

CARE AND MAINTENANCE

The laminate fronts can be cleaned with a soft cloth dampened in warm water and a mild household cleaner. Wipe with a dry, soft cloth.

We recommend using our surface care products.

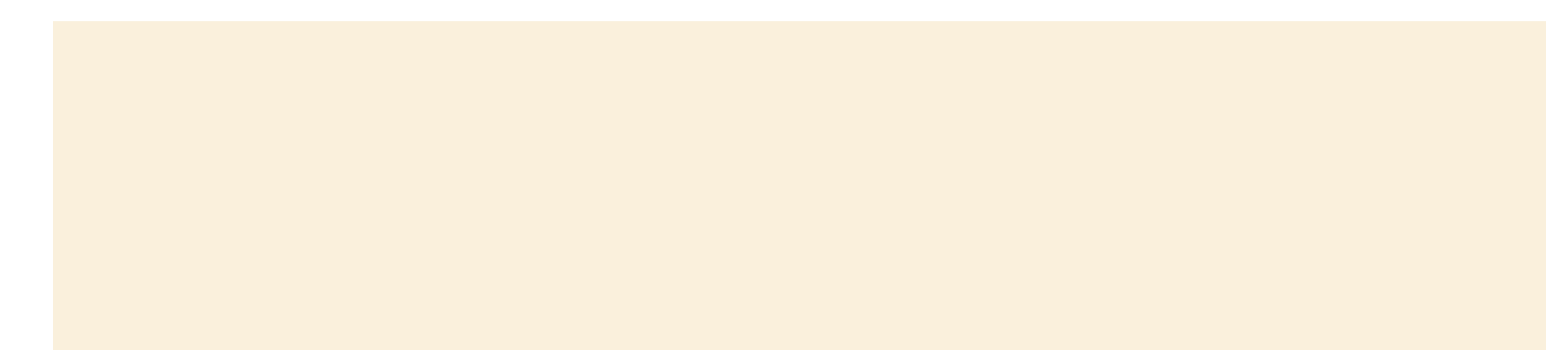

COTTON BEIGE

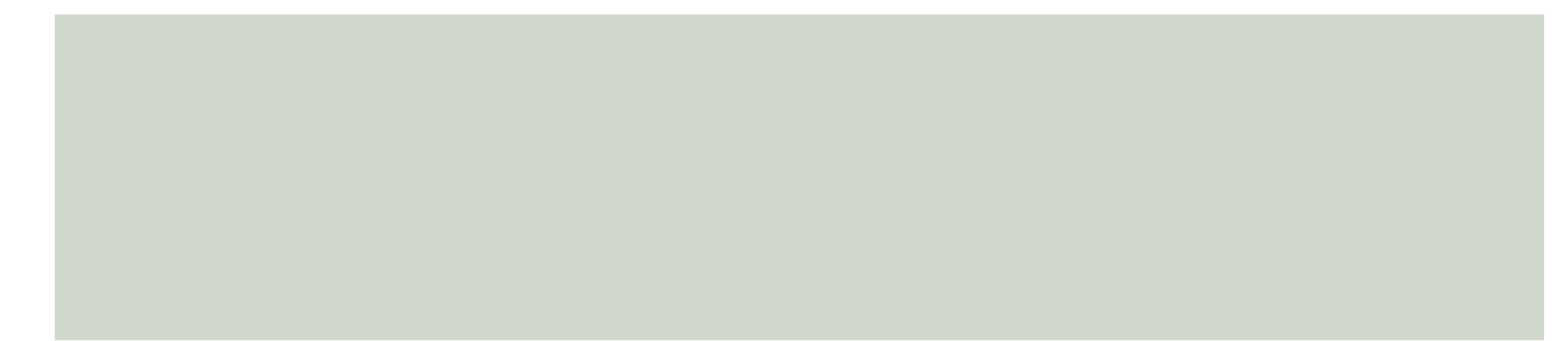

PISTACHIOS GREEN



FJORD GREEN



CURRY



SIGNAL RED



BRILLANT YELLOW



SMOKEY BLUE



KASCHMIR



GLACIER BLUE



NIAGARA GREEN



CARAMEL



FLAMINGO



DELFT BLUE



CHINA RED

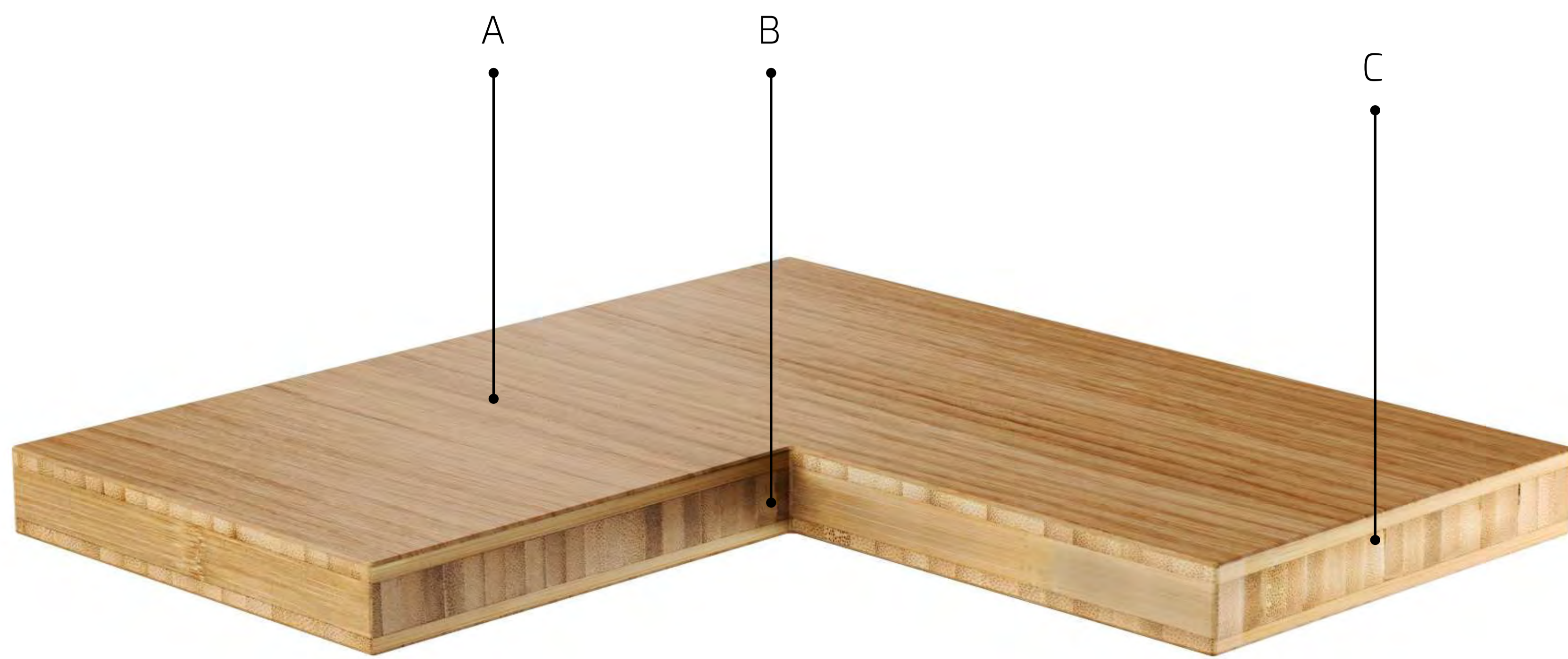

A = Front = 0,8 mm Holzfurnier
 B = Kern = Bambus 3 Schichtplatte 16mm
 C = Kante = Bambus 3 Schichtplatte geölt
 D = Rückseite 0,8 mm Holzfurnier

A = Front = 0,8 mm Wood Veneer
 B = Core = Bamboo 3 ply board 16mm
 C = Edge = Bamboo 3-layer board oiled
 D = Back side 0,8 mm Wood Veneer

PFLEGE UND WARTUNG

Die Holzoberfläche kann mit einem weichen, mit warmem Wasser angefeuchteten Tuch und einem milden Haushaltsreiniger (nicht fettlöslich !), vorzugsweise Seife, gereinigt werden. Anschließend mit einem trockenen, weichen Tuch nachreiben. Von Zeit zu Zeit mit unserem Holzpflegemittel intensiv pflegen, damit das Holz nicht austrocknet und leicht nachgeölt wird.

Wir empfehlen unsere speziell auf die Oberflächen abgestimmten Pflegemittel.

CARE AND MAINTENANCE

The wood surface can be cleaned with a soft cloth moistened with warm water and a mild household cleaner preferably soap. (not fat soluble!) Then rub with a dry, soft cloth. Occasionally treat with our wood care product to keep the wood does not dry out and is lightly oiled.

We recommend our care products specially formulated for the surfaces.



BAMBUS ECRU



BAMBUS CARMEL



OAK _ EICHE

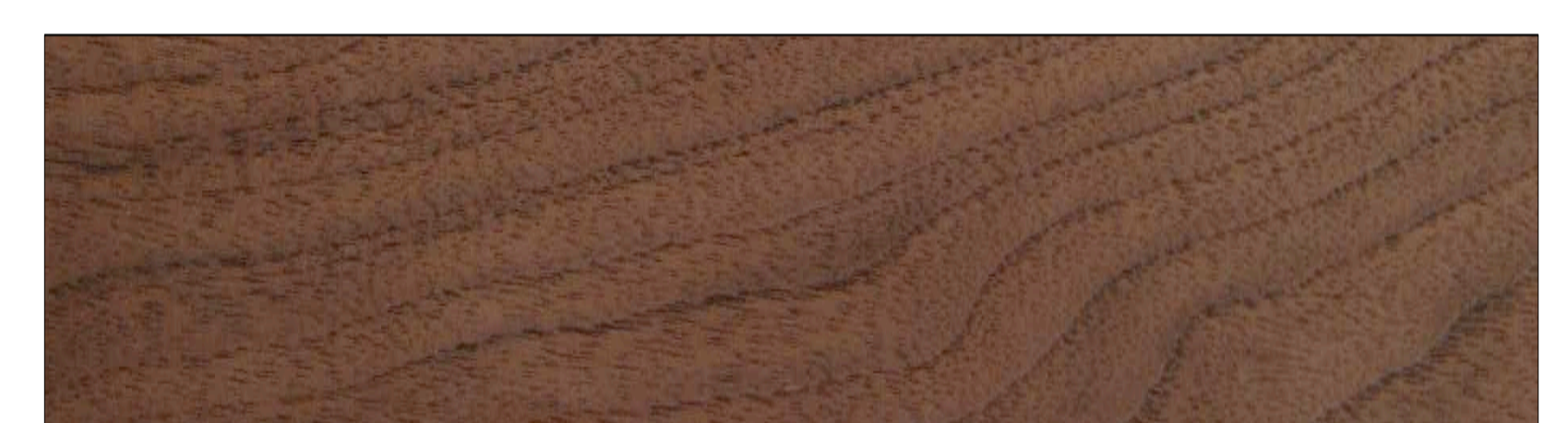

WALNUT _ WALNUSS

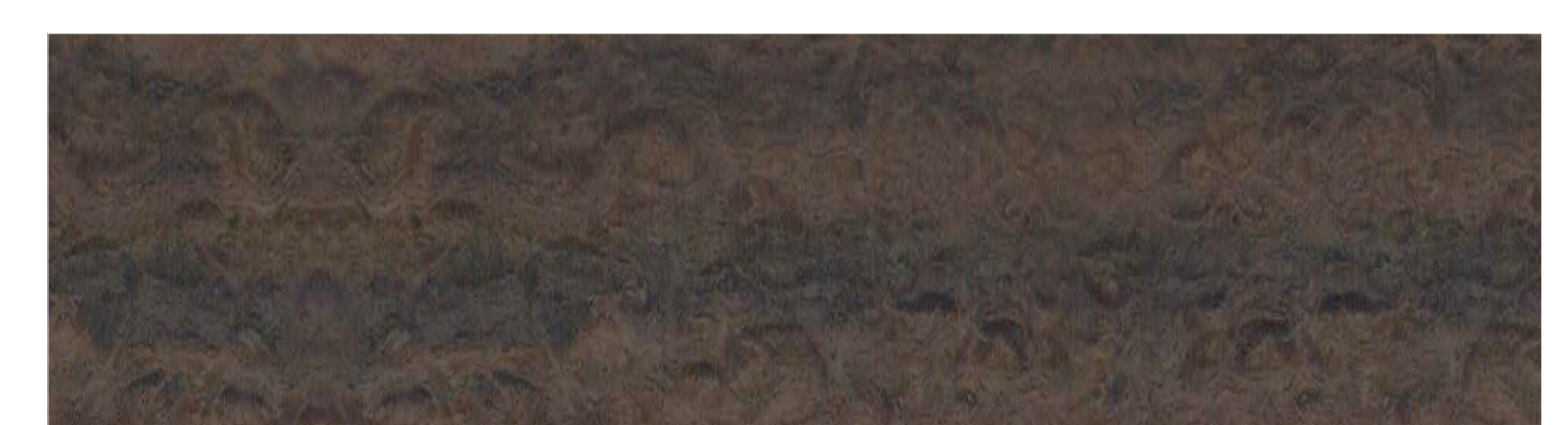

SMOKED OAK _ RÄUCHEREICHE

WORK TOP FACTS _ BAMBOO



BAMBUS 20MM GEÖLT IN CAMEL ODER ECRU. BAMBOO 20MM OILED IN CAMEL OR ECRU

PFLEGE UND WARTUNG

Die Holzoberfläche kann mit einem weichen, mit warmem Wasser angefeuchteten Tuch und einem milden Haushaltsreiniger (nicht fettlöslich!), vorzugsweise Seife, gereinigt werden. Anschließend mit einem trockenen, weichen Tuch nachreiben. Von Zeit zu Zeit mit unserem Holzpflegemittel intensiv pflegen, damit das Holz nicht austrocknet und leicht nachgeölt wird.

Wir empfehlen unsere speziell auf die Oberflächen abgestimmten Pflegemittel.

CARE AND MAINTENANCE

The wood surface can be cleaned with a soft cloth moistened with warm water and a mild household cleaner preferably soap. (not fat soluble!)
Then rub with a dry, soft cloth.
Occasionally treat with our wood care product to keep the wood does not dry out and is lightly oiled.

We recommend our care products specially formulated for the surfaces.



BAMBUS ECRU

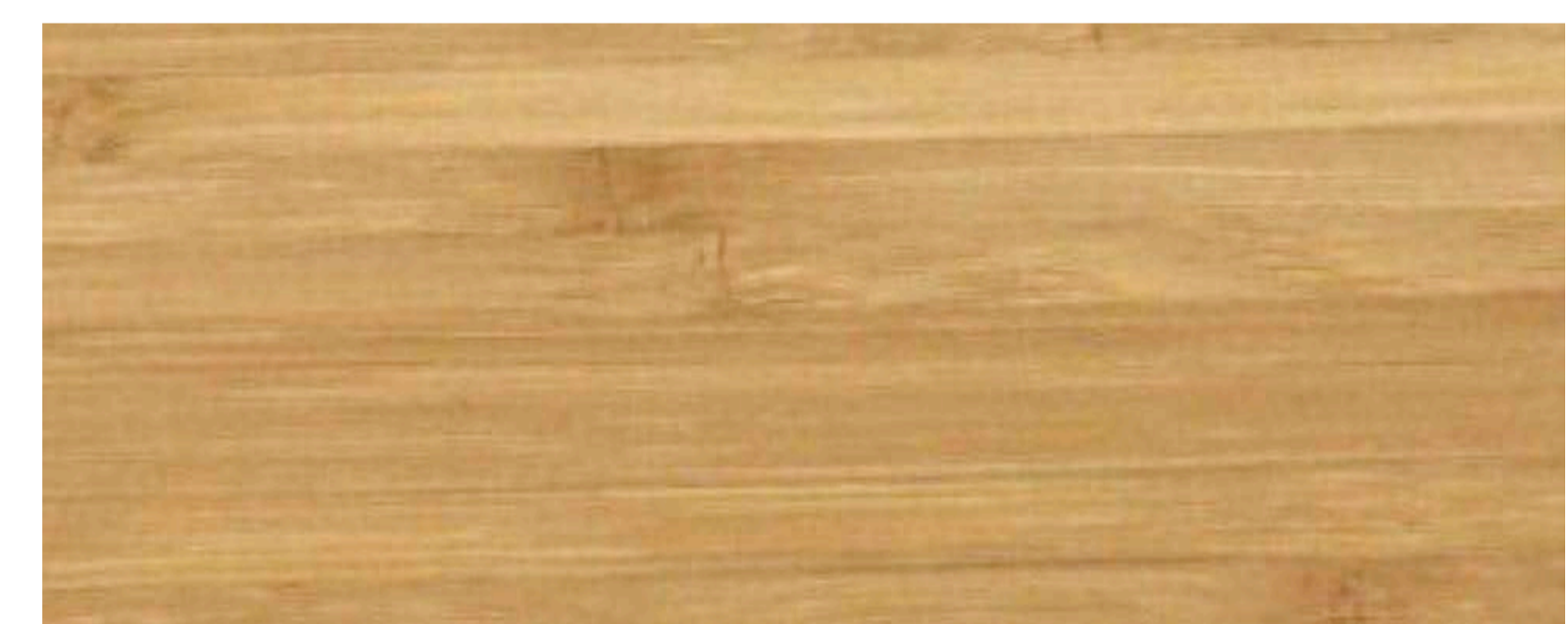

BAMBUS CAMEL



FANTOPLAST® 12/ 20/ 30mm

Fantoplast-Arbeitsplatten in den Stärken 12, 20 und 30 mm werden aus 100 % regionalem Recyclingkunststoff hergestellt und sind zu 100 % recycelbar. Die Produktion erfolgt mit 100% Ökostrom in der Wiener Seestadt.

Fantoplast® ist eine reine Kunststoffplatte mit vielfältigen Designs, die haptisch und optisch mit Corian vergleichbar ist. Die Platten sind in matter und polierter Ausführung erhältlich.

Fantoplast® besteht zur Gänze aus Kunststoffgranulat und kommt ohne Verbundstoffe wie bei Corian® oder Durat® aus. Die verwendeten Materialien stammen aus unterschiedlichen Bereichen wie 3D-Druck, Medizintechnik, Skiliftbau etc.

Fantoplast® bietet eine innovative Möglichkeit, Kunststoffabfälle zu neuen Produkten zu verarbeiten. Dabei wird eng mit regionalen Partnern aus Forschung und Kreislaufwirtschaft zusammengearbeitet.

Die Platten können nach ihrem Nutzungszyklus entweder aufbereitet oder vollständig recycelt werden, ganz im Sinne des Kreislaufprinzips - Kunststoffabfälle einer neuen Nutzung zuzuführen.

Fantoplast worktops in thicknesses of 12, 20 and 30 mm are made from 100% regionally recycled plastic and are 100% recyclable. They are manufactured in Vienna using 100% green electricity.

Fantoplast® is a pure plastic sheet with a variety of designs, comparable in look and feel to Corian. The sheets are available in matte and polished finishes.

Fantoplast® consists entirely of plastic granulate and does not require any composite materials, as is the case with Corian® or Durat®. The materials used come from various sectors such as 3D printing, medical technology, ski lift construction, etc.

Fantoplast® offers an innovative way to transform plastic waste into new products. The company works closely with regional partners in research and recycling.

At the end of their useful life, the sheets can either be reprocessed or completely recycled, in line with the circular economy principle of re-using plastic waste.



COLOUR FRECKLES - NEBULA



COLOUR FRECKLES - SCUBA BLUE



DUO GRAINS - CELESTE



DUO GRAINS - GRAVEL



DUO GRAINS - MARIN

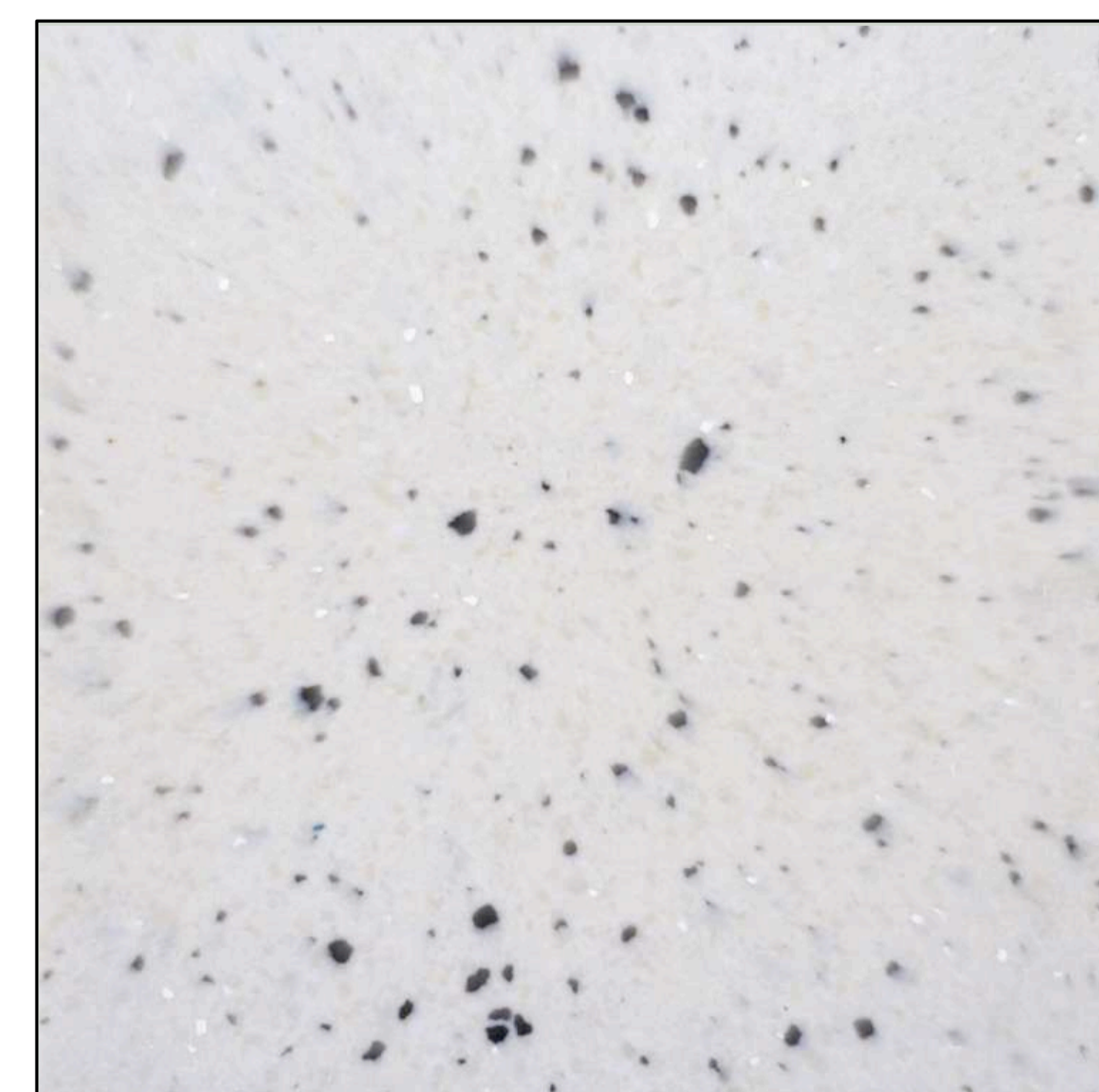

DUO GRAINS - PEBBLE



DURAT® 12MM

Durat® ist ein Mineralwerkstoff eine Mischung aus Mineralien und Acryl.

Technische Eigenschaften von Durat®:

- Durat® ist ein robustes und strapazierfähiges Material, das stoß- und schnittfest und gegen die meisten Beanspruchungen beständig ist.
- Oberflächen aus Durat® sind fugenlos, so dass sich dort keine Pilze oder Bakterien ansiedeln können.
- Durat® ist einfach zu reinigen, da Flecken nicht eindringen können, sondern auf der Oberfläche bleiben.
- Durat® ist nicht hitzebeständig, man sollte keine heißen Töpfe ohne Untersetzer daraufstellen.

Durat® is a solid surface material made from a mixture of minerals and acrylic.

Technical properties of Durat®:

- Durat® is a tough and durable material that is impact and cut resistant and can withstand most wear and tear.
- Durat® surfaces are seamless, preventing the growth of fungi and bacteria.
- Durat® is easy to clean because stains do not penetrate but remain on the surface.
- Durat® is heat-resistant up to 180 degrees Celsius.

PFLEGE UND WARTUNG

Die Durat® Oberfläche kann mit einem weichen, mit warmem Wasser angefeuchteten Tuch und einem milden Haushaltsreiniger gereinigt werden.

Anschließend mit einem trockenen, weichen Tuch nachreiben.

Wir empfehlen unsere speziell auf die Oberflächen abgestimmten Pflegemittel.

CARE AND MAINTENANCE

The Durat® surface can be cleaned with a soft cloth moistened with warm water and a mild household cleaner. Then wipe with a dry, soft cloth.

We recommend our care products specially formulated for the surfaces.



D0100 51 White

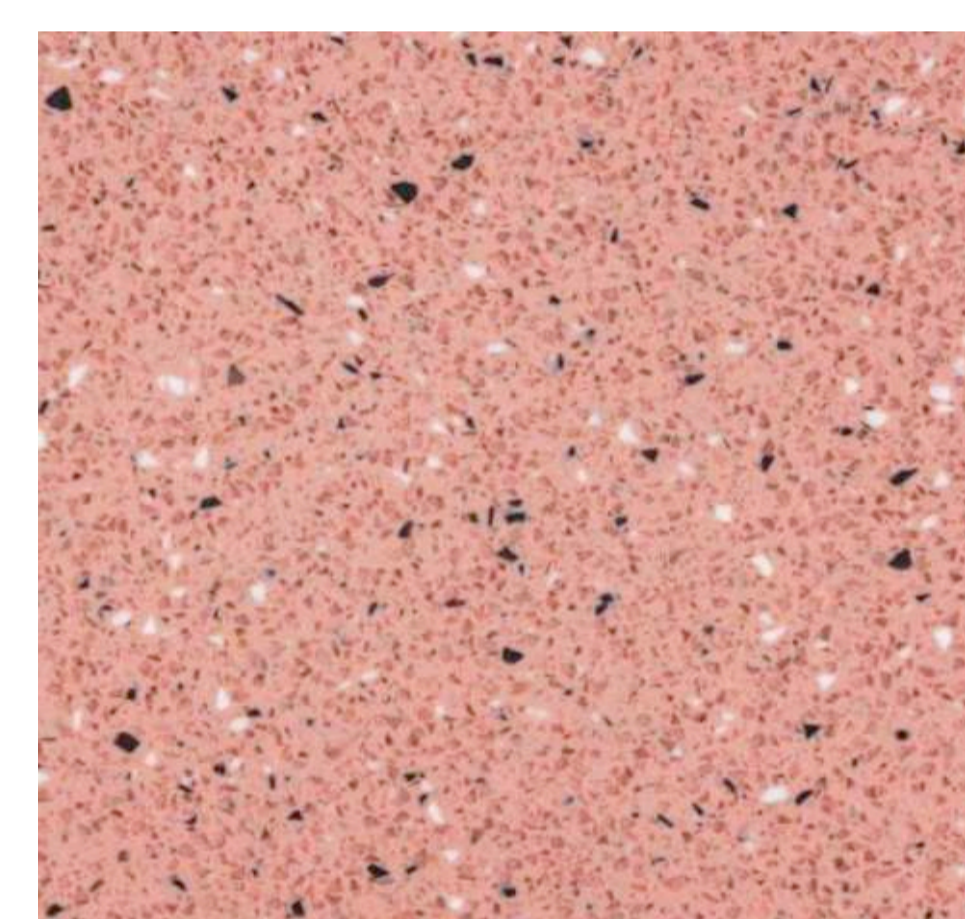

R3014-04 ANTIQUE PINK



R5003 02 SAPPHIRE BLUE



D0060 53 BLACK

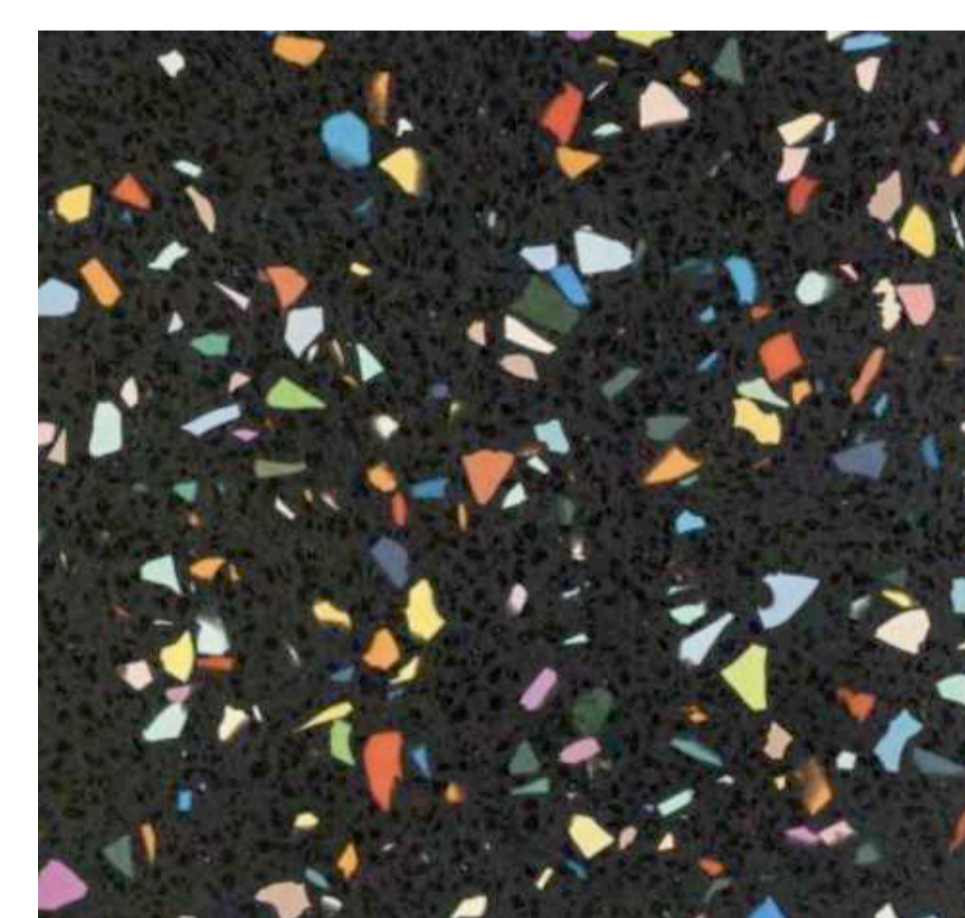

D0060 52 BLACK



D0700-08 BLACK

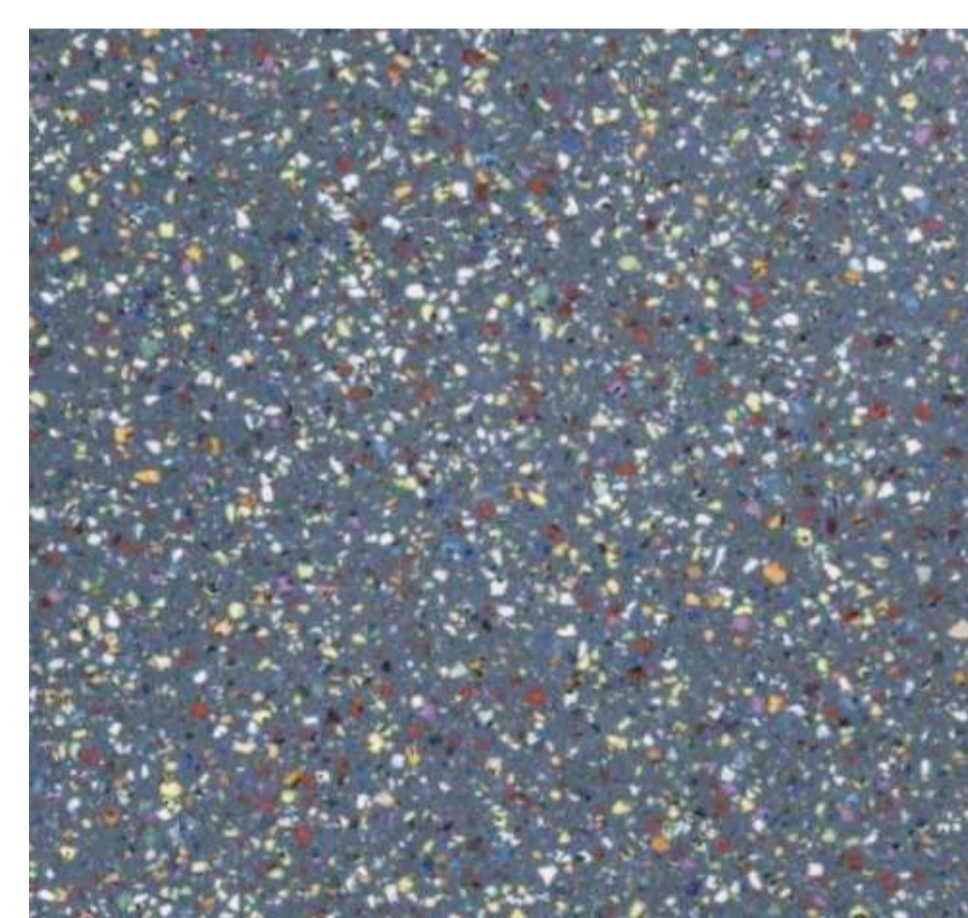

D0700-08 DARK BLUE

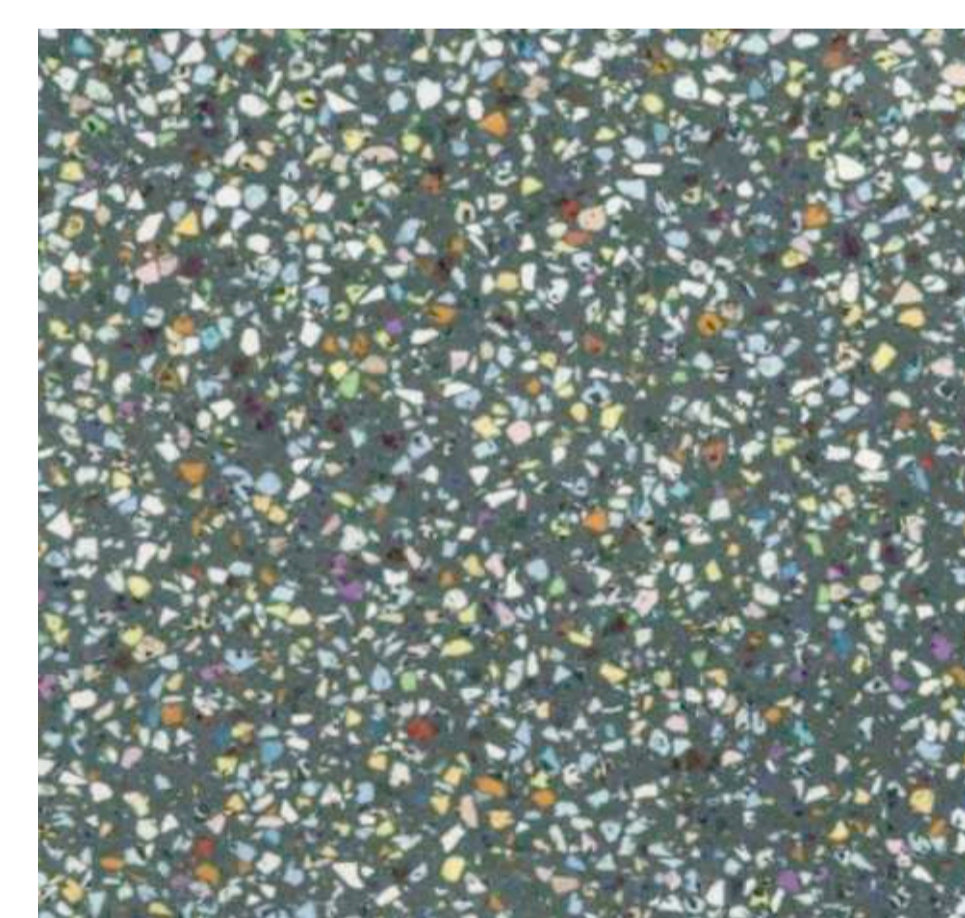

D0270 08 DARK GREEN



D0200 02 MEDIUM GREEN

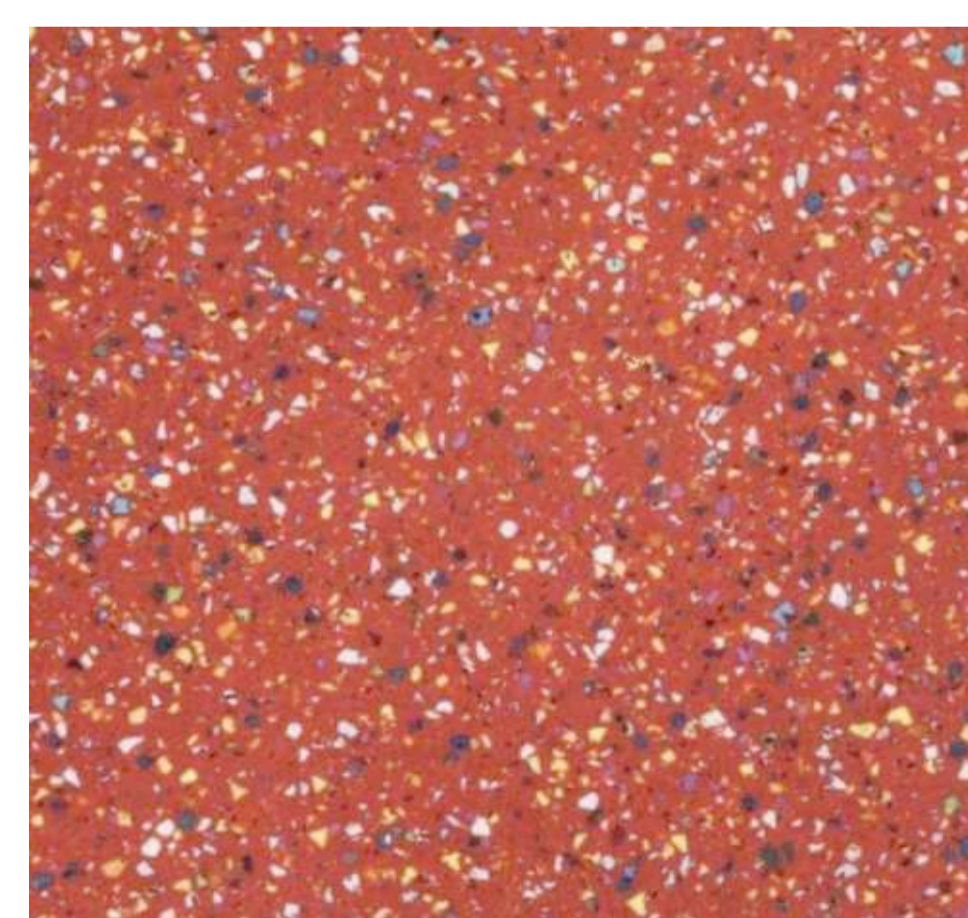

D00070 08 DEEP RED



D0030-08 GREY



D0390 08 GREY BLUE



D0100 52 WHITE

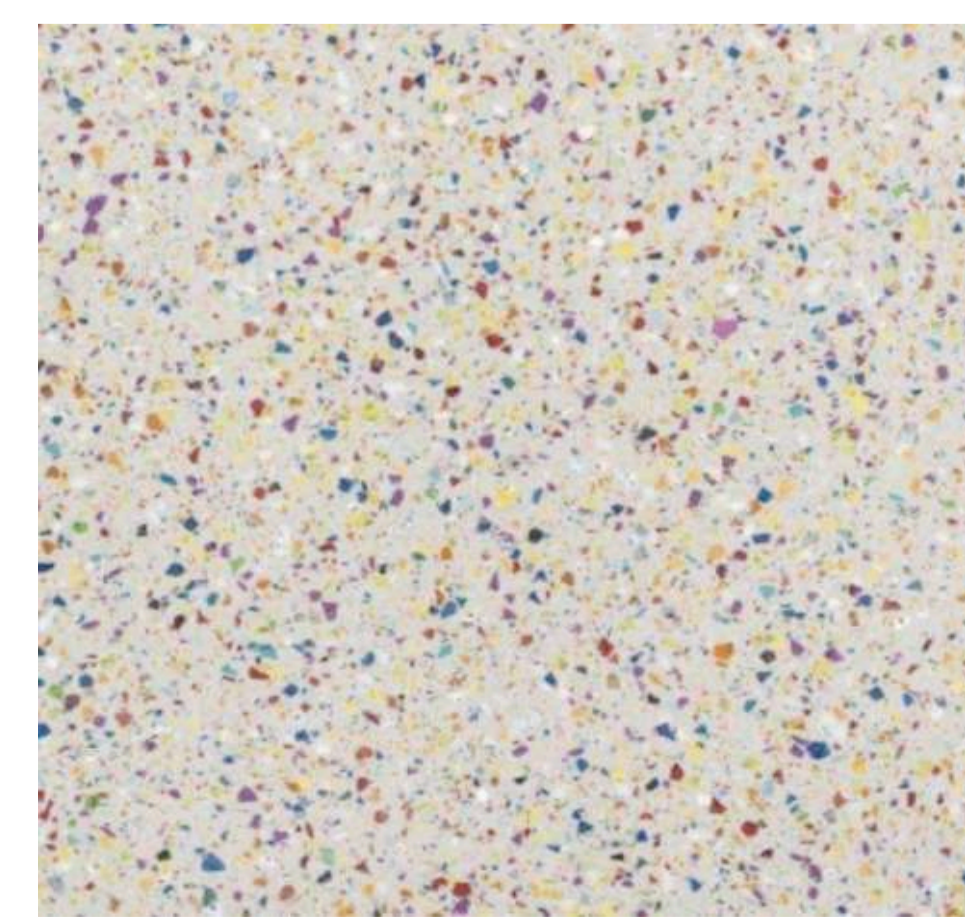

D0730 02 LIGHT GREY

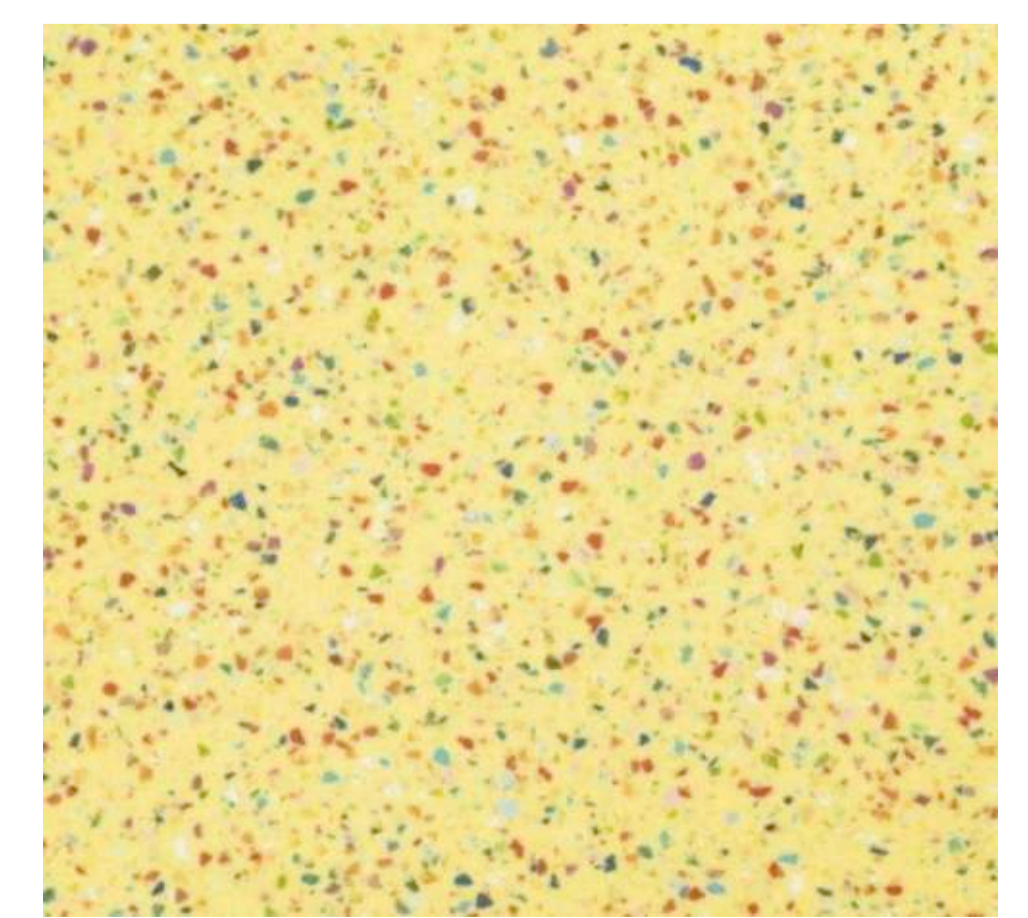

D0090 08 BRIGHT YELLOW



CORIAN® 12MM

Corian® ist ein Mineralwerkstoff eine Mischung aus Mineralien und Acryl.

Technische Eigenschaften von Corian®:

- Corian® ist ein robustes und strapazierfähiges Material, das stoß- und schnittfest und gegen die meisten Beanspruchungen beständig ist.
- Oberflächen aus Corian® sind fugenlos, so dass sich dort keine Pilze oder Bakterien ansiedeln können.
- Corian® ist einfach zu reinigen, da Flecken nicht eindringen können, sondern auf der Oberfläche bleiben.
- Durch die Pflege mit einem normalen Reinigungsmittel oder einem Scheuermittel und einem Schwamm werden die Oberflächen aus Corian® wieder wie neu. Größere Schäden können repariert werden, indem Teile aus demselben Material nicht sichtbar eingesetzt werden.
- Corian® ist nicht hitzebeständig, man sollte keine heißen Töpfe ohne Untersetzer daraufstellen.

Corian® is a solid surface material made from a mixture of minerals and acrylic.

Technical properties of Corian®:

- Corian® is a tough and durable material that is impact and cut resistant and can withstand most wear and tear.
- Corian® surfaces are seamless, preventing the growth of fungi and bacteria.
- Corian® is easy to clean because stains do not penetrate but remain on the surface.
- Maintenance with a normal cleaning agent or a scouring agent and a sponge will make Corian® surfaces as good as new again. Major damage can be repaired by replacing parts made of the same material that are not visible.
- Corian® is heat-resistant up to 180 degrees Celsius.

PFLEGE UND WARTUNG

Die Corian® Oberfläche kann mit einem weichen, mit warmem Wasser angefeuchteten Tuch

und einem milden Haushaltsreiniger gereinigt werden. Anschließend mit einem trockenen, weichen Tuch nachreiben.

Wir empfehlen unsere speziell auf die Oberflächen abgestimmten Pflegemittel.

CARE AND MAINTENANCE

The Corian® surface can be cleaned with a soft cloth moistened with warm water and a mild household cleaner. Then wipe with a dry, soft cloth.

We recommend our care products specially formulated for the surfaces.

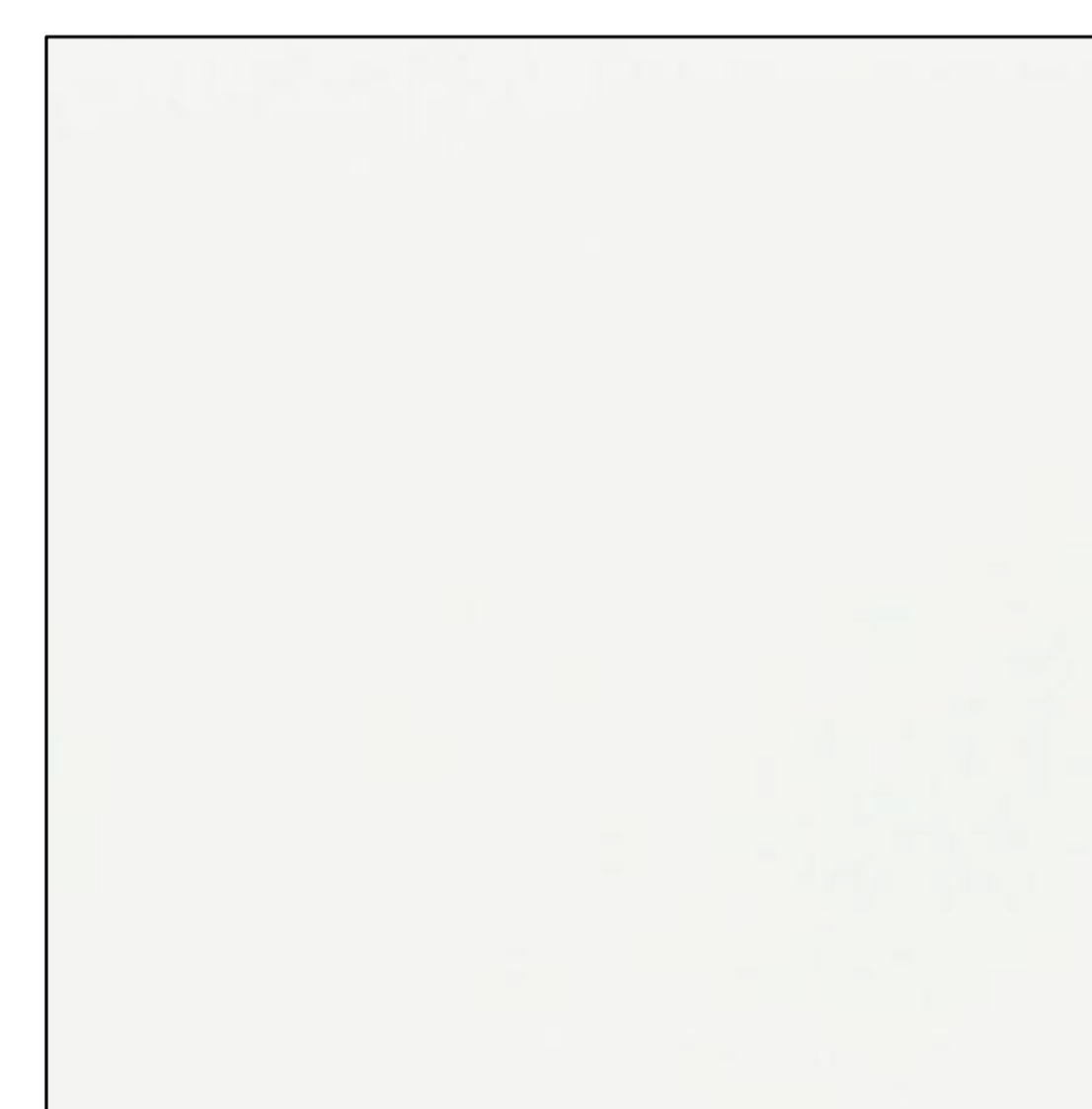

GLACIER WHITE

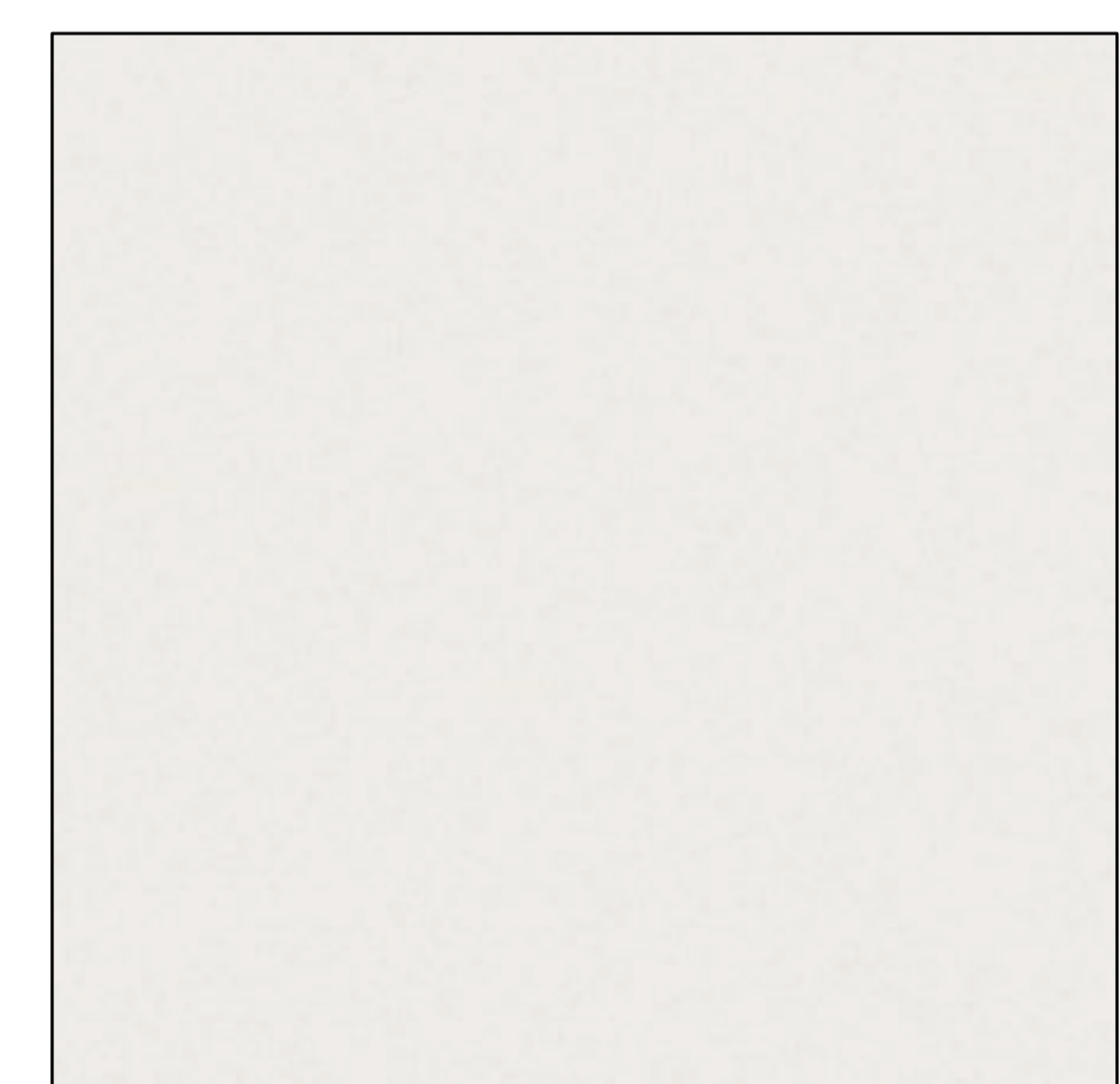

Cameo White

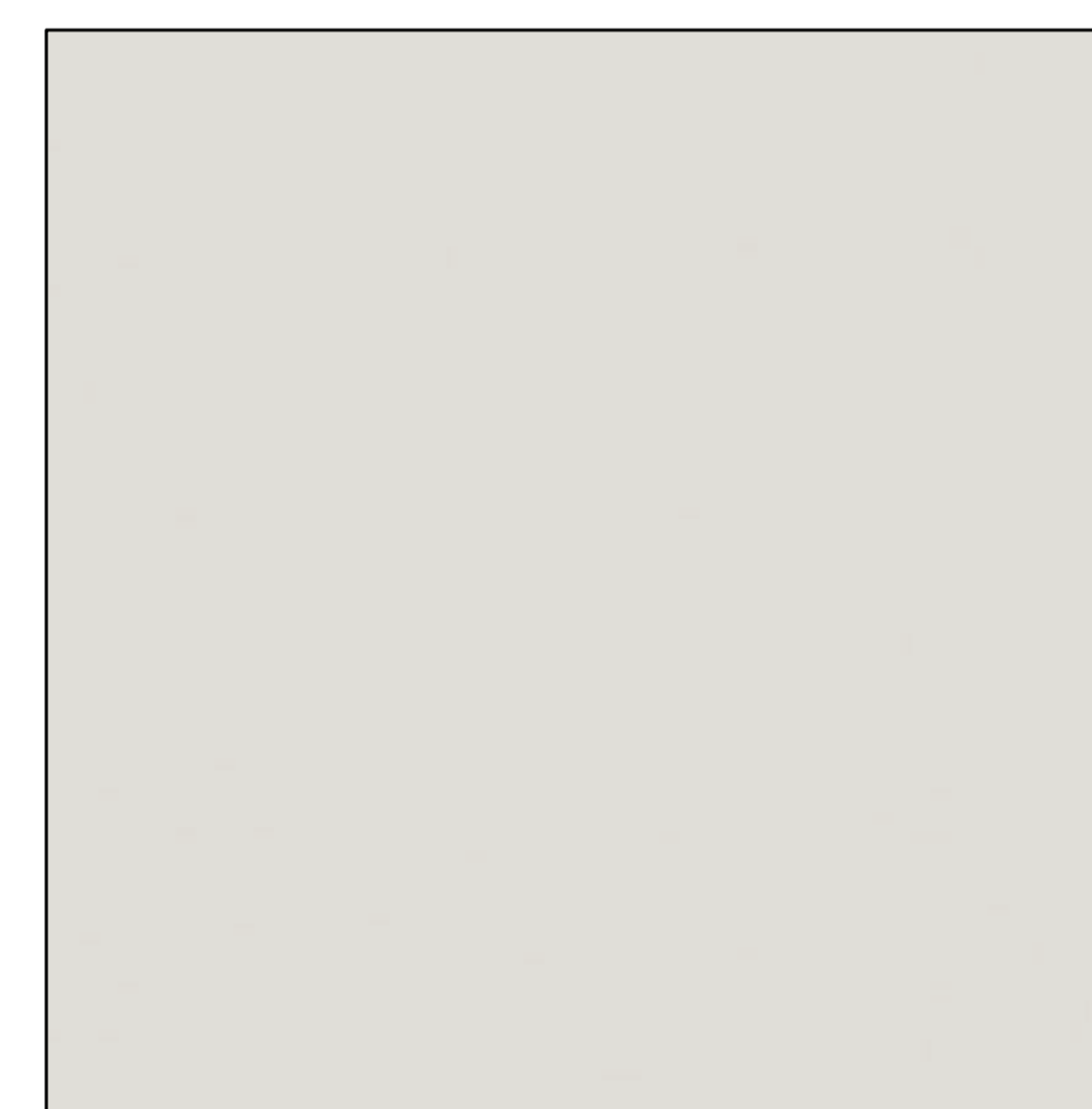

PEARL GRAY

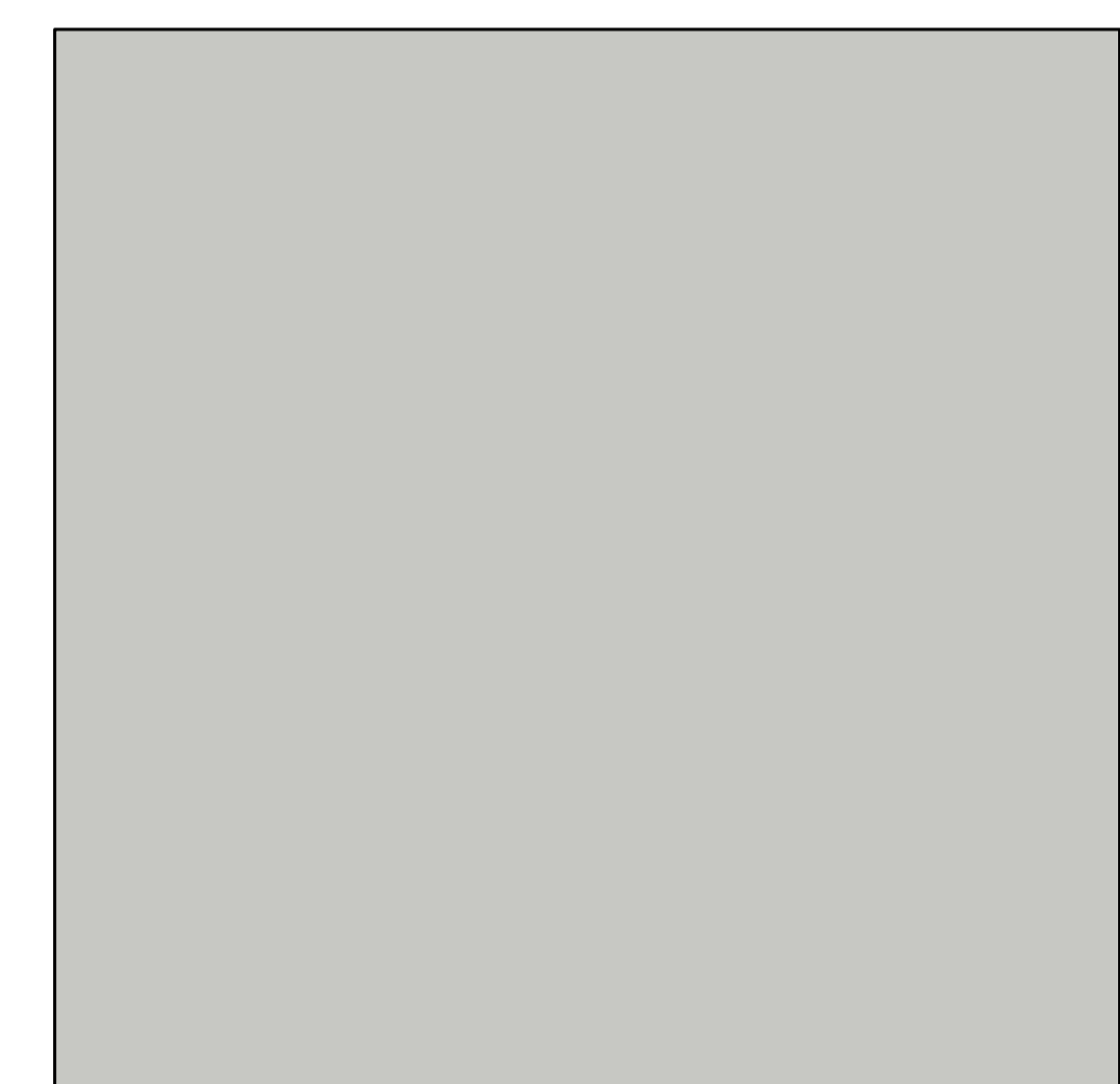

SILVER GRAY

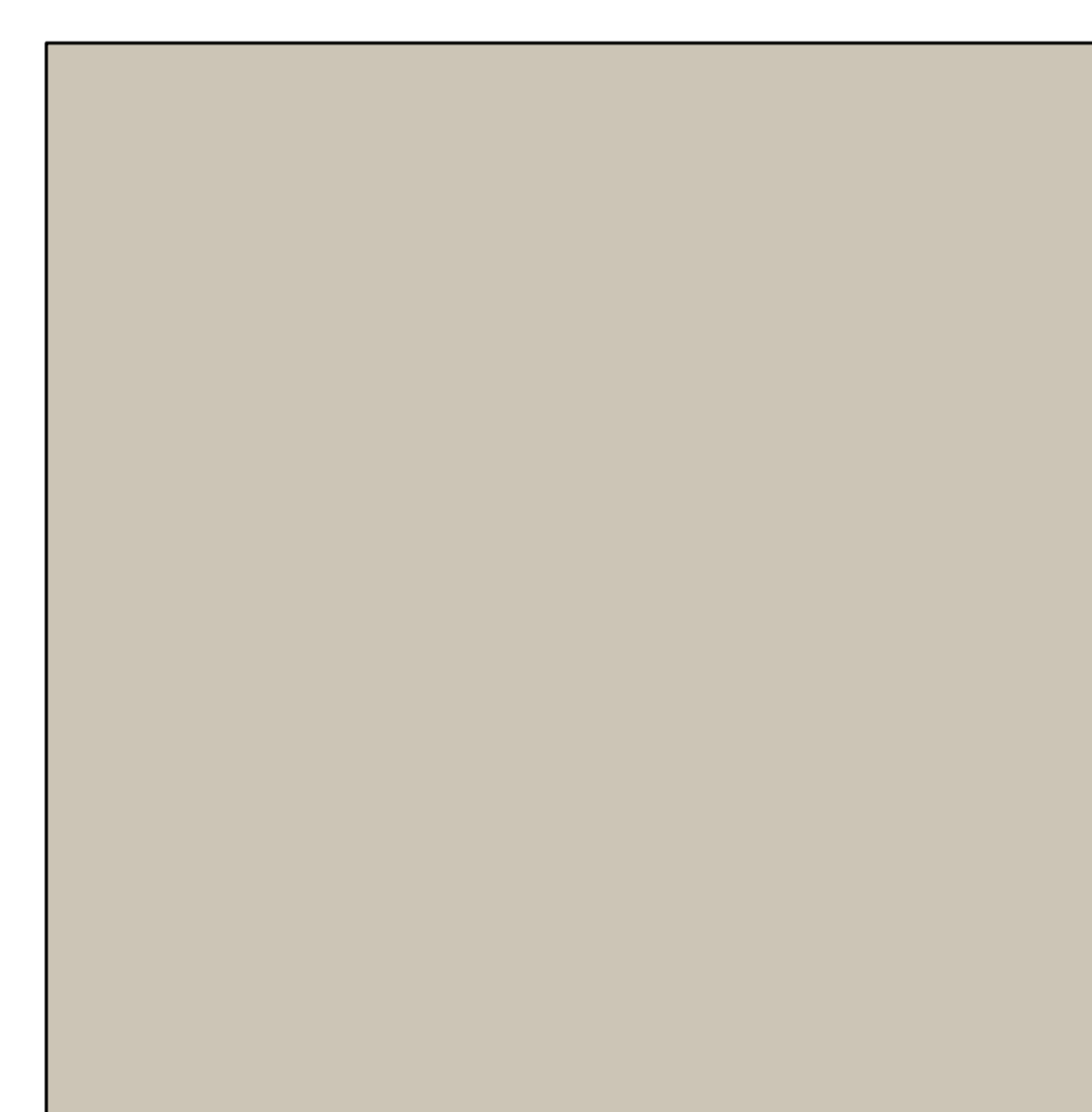

ELEGANT GRAY

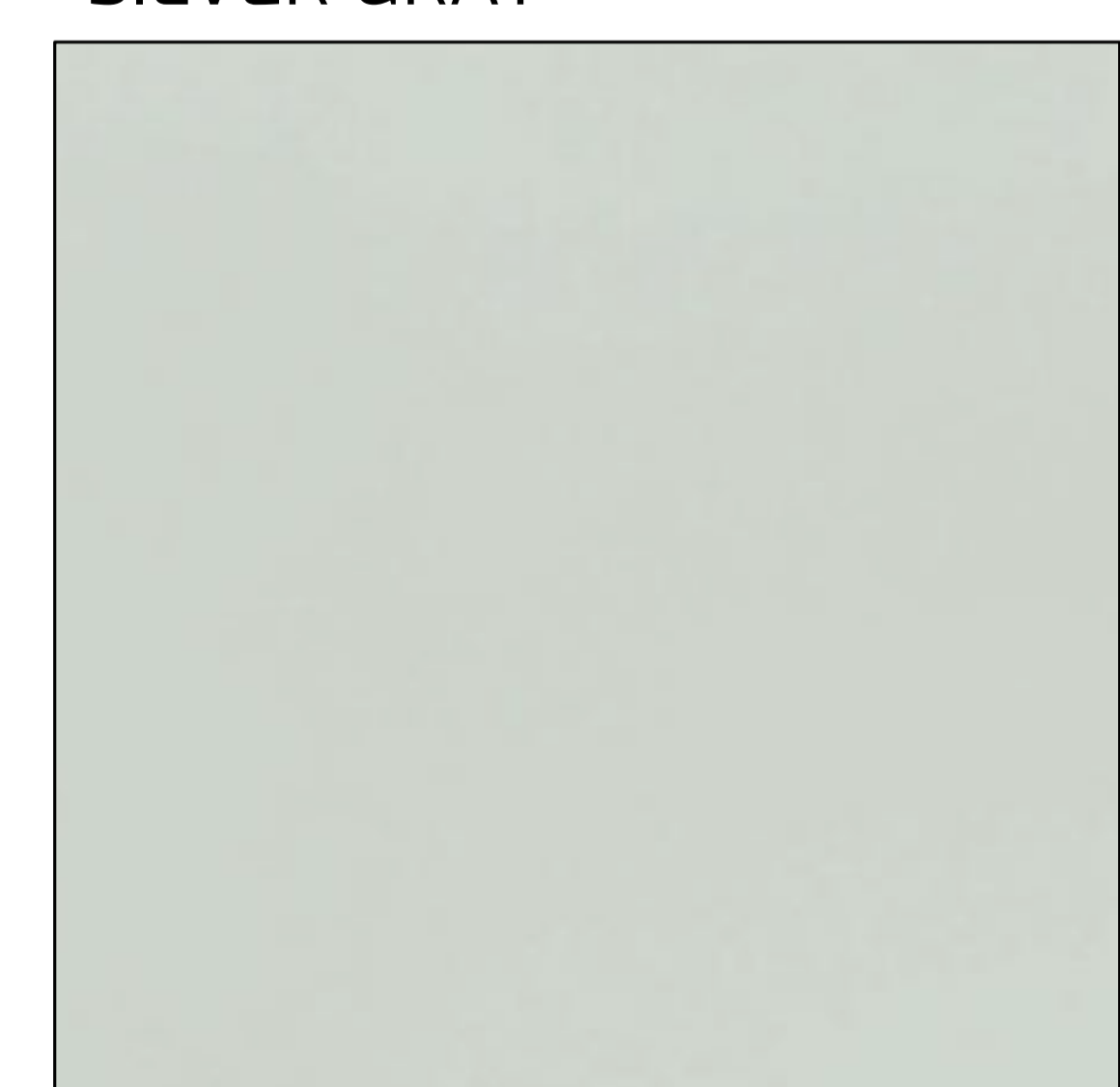

SEEGRASS



WARMGEWALZTER EDELSTAHL 4MM UNBEHANDELT

HOT ROLLED STAINLESS STEEL 4MM UNTREATED

PFLEGE UND WARTUNG

Die Edelstahl Arbeitsplatte kann man mit einem weichen, in warmem Wasser angefeuchteten Tuch und einem milden Haushaltsreiniger gereinigt werden. Anschließend mit einem trockenen, weichen Tuch nachreiben.

Wir empfehlen unsere auf die Oberflächen abgestimmten Pflegemittel.

CARE AND MAINTENANCE

The stainless steel worktop can be cleaned with a soft cloth dampened in warm water and a mild household cleaner. Then wipe with a dry, soft cloth.

We recommend using our surface care products.

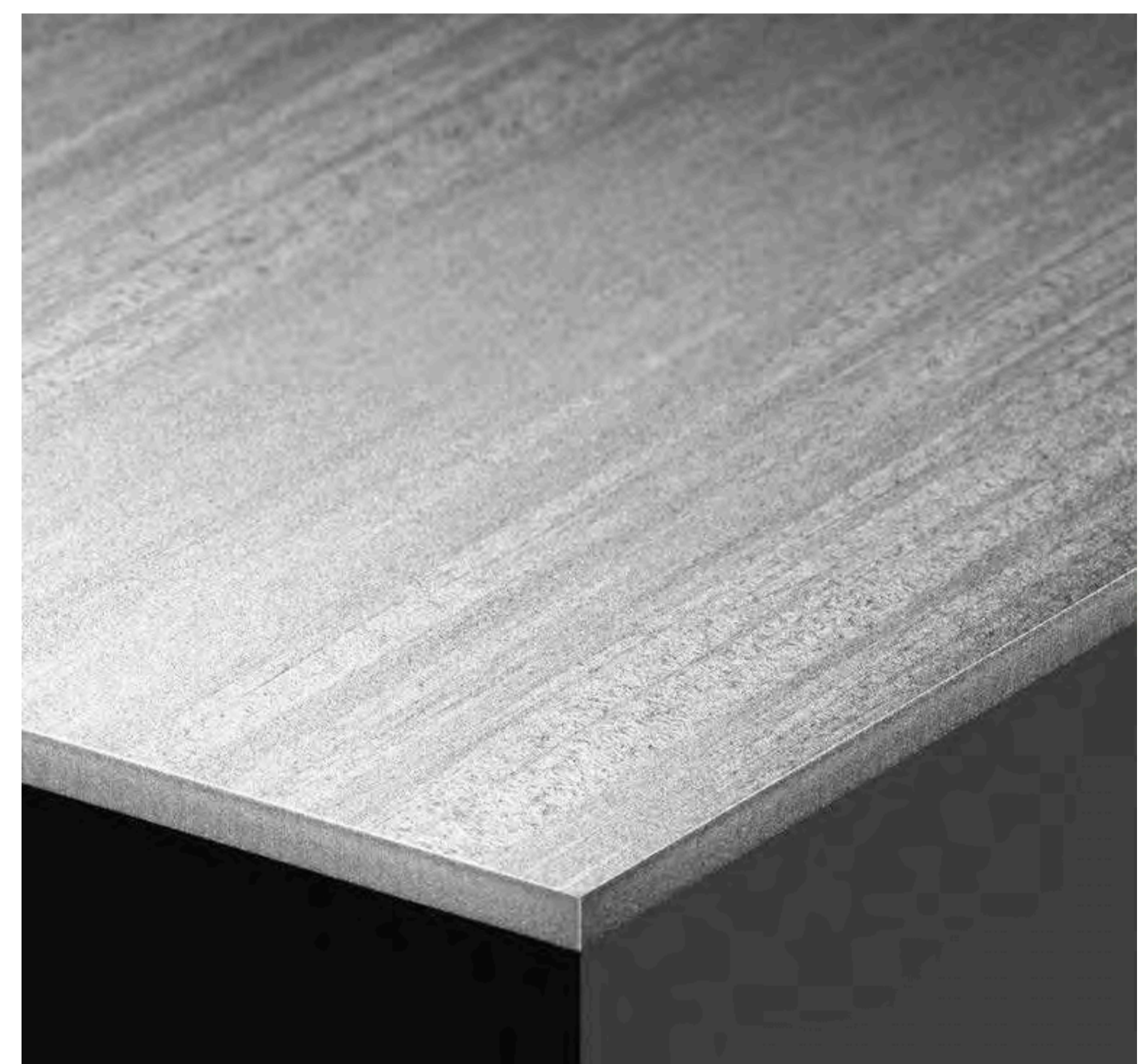



DEVICES

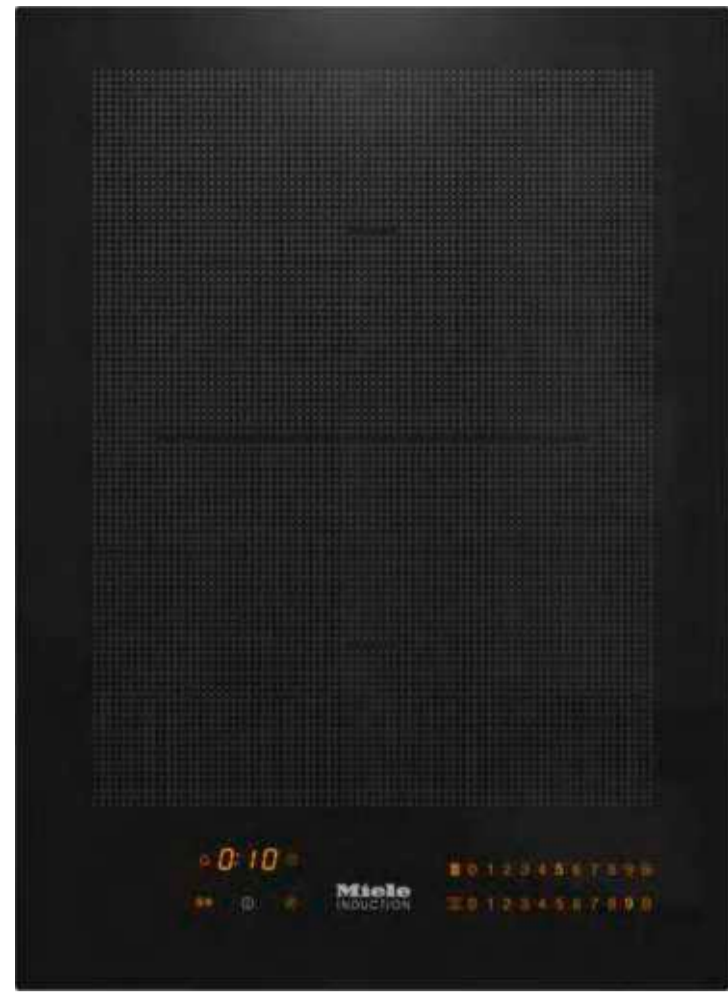

Kochfeld 23cm Breite
Miele CS 7612 FL Schwarz
Mit induktionsbeheiztem
PowerFlex-Kochbereich

Hob 23cm width
Miele CS 7612 FL Black
With induction-heated
PowerFlex cooking area



Dometic DM50NTE F
Schubladen-Minibar
Drawer minibar
Praktischer Zugriff per
Schublade, lautloser
thermoelektrischer
Betrieb, niedriger
Energieverbrauch -

Dometic DM50NTE F
Schubladen-Minibar
Drawer minibar
Practical drawer access,
silent thermoelectric
operation, low
energy consumption -

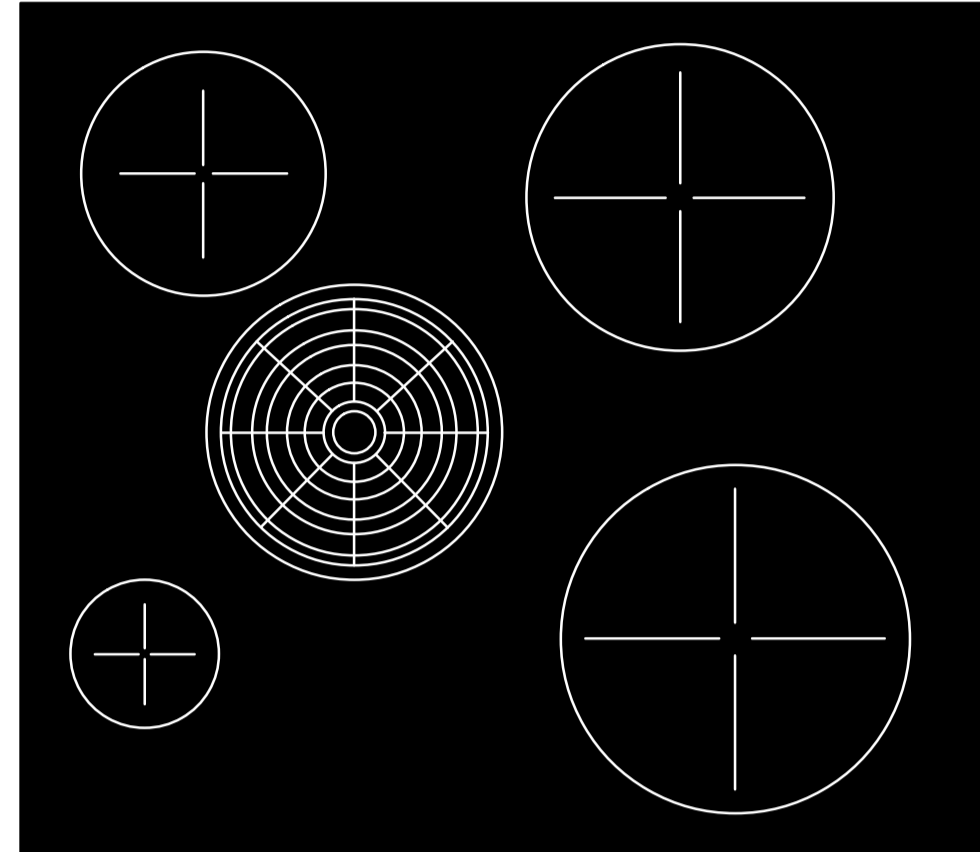

PURSU 5 Pure Induktions-
Kochfeld mit integriertem
Kochfeldabzug - Umluft

PURSU 5 Pure induction
cooktop with integrated
cooktop extractor -
convection



Einbau-Kühlschrank 90cm

Built-in refrigerator 90cm

K 7127 D
Mit DailyFresh, LED-
Beleuchtung, SoftClose
und SuperKühlen für mehr
Komfort.

K 7127 D
With DailyFresh, LED
lighting, SoftClose and
SuperCooling for more
convenience.

K 7128 D
Mit DailyFresh, 4*
Gefrierfach, LED-
Beleuchtung, und
SoftClose für mehr
Komfort.

K 7128 D
With DailyFresh, 4*
freezer
compartment, LED
lighting and
SoftClose for more
convenience.



Kompakt-Backofen
H 2841 B Edelstahl/
CleanSteel

Compact oven
H 2841 B Stainless steel/
CleanSteel



Einbau-Kühlschrank 120cm

Built-in refrigerator 120cm

K 7327 D
Mit DailyFresh, LED-
Beleuchtung, SoftClose
und SuperKühlen für mehr
Komfort.

K 7327 D
With DailyFresh, LED
lighting, SoftClose and
SuperCooling for more
convenience.

Einbau-Kühlschrank
K 7328 D
Mit 4*-Gefrierfach, LED
Beleuchtung, SoftClose
und SuperKühlen für mehr
Komfort.

Built-in refrigerator
K 7328 D
With 4* freezer
compartment, LED
lighting, SoftClose and
SuperCool for more
convenience.



Kompakt-Backofen
H 7244 BP
Obsidianschwarz

Compact oven
H 7244 BP Obsidian black



Kompakt-Backofen mit
Mikrowelle
H 7440 BM
Obsidianschwarz
Im perfekt kombinierbaren
Design mit
Automatikprogrammen u.
Kombi-Betriebsarten.

Compact oven with
microwave
H 7440 BM Obsidian black
In a perfectly combinable
design with automatic
programs and combi
operating modes.



Einbau-Kühlschrank 140cm

Built-in refrigerator 140cm

K 7443 D
Mit PerfectFresh Pro für
längere Frische, moderner
LED-Beleuchtung und
DynaCool.

K 7443 D
With PerfectFresh Pro for
longer freshness, modern
LED lighting and
DynaCool.

Einbau-Kühlschrank
K 7444 D
Mit PerfectFresh Pro für
längere Frische, LED-
Beleuchtung und 4*-
Gefrierfach.

Built-in refrigerator
K 7444 D
With PerfectFresh Pro for
longer freshness, LED
lighting and 4* freezer
compartment.

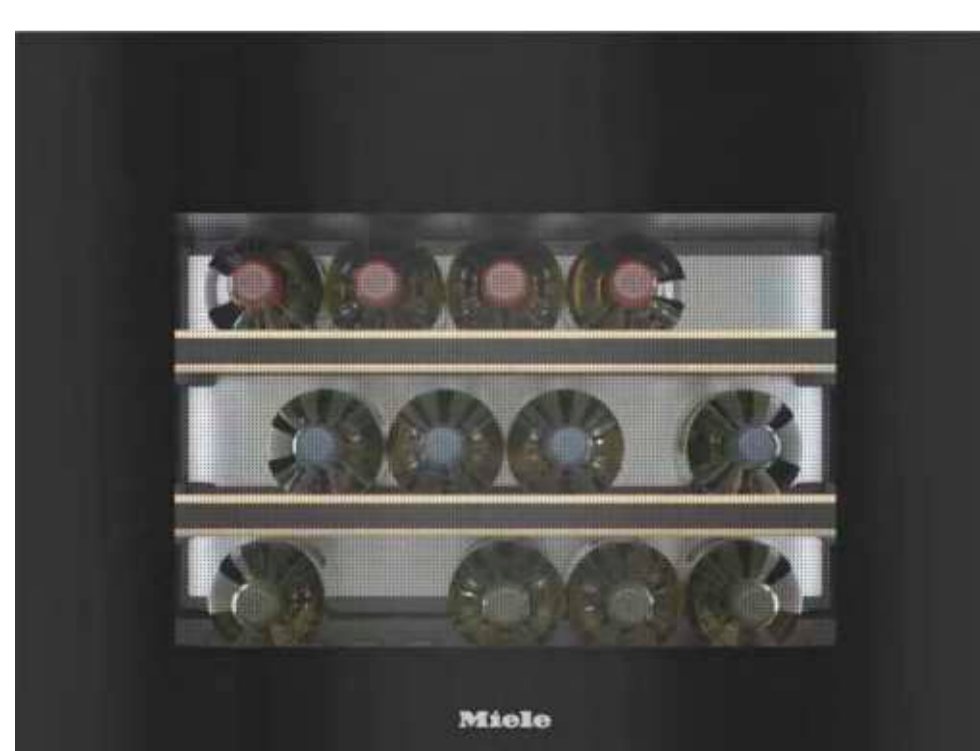

Einbau-
Weintemperierschrank
KWT 7112 iG
Obsidianschwarz Glas
Mit FlexiFrame Plus und
Push2open für
anspruchsvollste
Weinliebhaber.

Built-in wine temperature
control cabinet
KWT 7112 iG Obsidian black
glass
With FlexiFrame Plus and
Push2open for the most
demanding wine lovers.

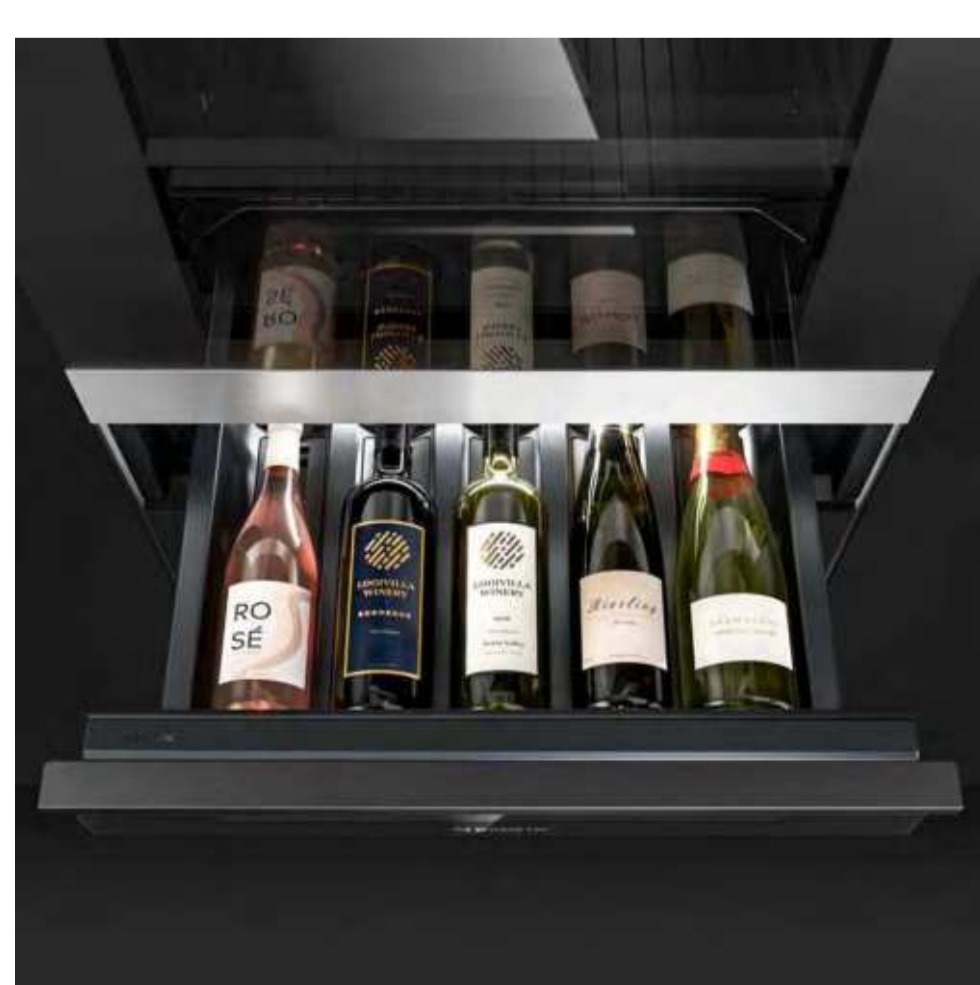

Dometic DrawBar 55
Vollintegrierte
Weinschublade Drawer
Perfekte
Serviertemperatur für
jeden Wein (5, 8, 11, 14 oder
17C)
effiziente
Kompressorkühltechnik
Platz für 5 Flaschen

Dometic DrawBar 55
Fully integrated wine
drawer Drawer
Perfect serving
temperature for every
wine (5, 8, 11, 14 or 17C)
Efficient compressor
cooling technology
Space for 5 bottles

DEVICES



Fisher & Paykel Schublade
Spülmaschine DD60SHTI9
integrierbar

Fisher & Paykel Dishwasher
drawer DD60SHTI9
integrable



DRINK.HOT EVOL-S PRO
Die semiprofessionelle 4-
in-1-Mischbatterie EVOL-S
Pro drink.hot gibt Ihnen auf
Knopfdruck eine exakte
Menge 100°C gefiltertes
oder perfekt gefiltertes
kaltes Wasser.

DRINK.HOT EVOL-S PRO
The semi-professional 4-
in-1 mixer tap EVOL-S Pro
drink.hot gives you an exact
amount of 100°C filtered or
perfectly filtered cold water
at the touch of a button.



G 5790 SCVi SL Edelstahl
CleanSteel

G 5790 SCVi SL stainless
steel CleanSteel



**DRINK.SODA EVOL-S
PRO**
5-in-1 Semi-Profi-Armatur:
Kaltes, warmes, sowie
gekühltes, veredeltes
Wasser still, medium und
sprudelnd
Still, medium, sprudelnd:
Kohlensäuregehalt des
gefilterten Wassers wählbar
über separates Drehrad

**DRINK.SODA EVOL-S
PRO**
5-in-1 semi-professional
tap: Cold, warm and chilled,
refined water still, medium
and sparkling
Still, medium, sparkling:
carbon dioxide content of
the filtered water can be
selected via a separate dial



CATRIS-S FLEXO
Zweistrahlsbrause mit
integriertem Durchfluss-
Stopp: für leichtes
Wechseln von Perlstrahl
auf Brausestrahl
Komfortable Arretierung
der Brause durch präzise
Magnethalterung

CATRIS-S FLEXO
Dual-jet shower head with
integrated flow stop: for
easy switching from pearl
jet to shower jet
Convenient locking of the
shower head with precise
magnetic holder



TALIA
Schock Armatur schwarz
matt
ausziehbarer Auslauf
elegantes Design
Anschlussschlauch
600mm
Schwenkradius 360Grad

TALIA
Schock mixer tap black
matt
pull-out spout
elegant design
connection hose 600mm
360 degree swivel radius



BLANCO ANDANO
Edelstahlbecken mit der
Breite 400 U Unterbau
Hochwertige Ausstattung
mit verdecktem Überlauf C-
overflow und Ablaufsystem
InFino – elegant integriert
und besonders pflegeleicht

BLANCO ANDANO
Stainless steel basin with
400 U undermount width
High-quality equipment with
concealed overflow C-
overflow and InFino drain
system - elegantly
integrated and particularly
easy to clean



BLANCO ANDANO
Edelstahlbecken mit der
Breite 450U Unterbau
Hochwertige Ausstattung
mit verdecktem Überlauf C-
overflow und Ablaufsystem
InFino – elegant integriert
und besonders pflegeleicht

BLANCO ANDANO
Stainless steel basin with
450U undermount width
High-quality equipment with
concealed overflow C-
overflow and InFino drain
system - elegantly
integrated and particularly
easy to clean



BLANCO ANDANO
Edelstahlbecken mit der
Breite 500 U Unterbau
Hochwertige Ausstattung
mit verdecktem Überlauf C-
overflow und Ablaufsystem
InFino – elegant integriert
und besonders pflegeleicht

BLANCO ANDANO
Stainless steel basin with
500 U undermount width
High-quality equipment with
concealed overflow C-
overflow and InFino drain
system - elegantly
integrated and particularly
easy to clean

Haftungsausschluss / Disclaimer

Errors and technical modifications excepted.

Due to continuous improvements through research and development, Neuvermoebelt reserves the right to change product specifications or features without prior notice. Neuvermoebelt is not liable for printing errors. The publication of images and graphics requires written authorisation.

Irrtümer und technische Änderungen vorbehalten.

Aufgrund fortwährender Verbesserungen durch Forschung und Entwicklung behält sich Neuvermoebelt das Recht vor, Produktspezifikationen oder Ausstattungsmerkmale ohne vorherige Ankündigungen zu ändern. Neuvermoebelt haftet nicht für Druckfehler. Die Veröffentlichung von Bildern und Grafiken bedarf der schriftlichen Zustimmung.

IMPRESSUM

Gemäß § 5 E-Commerce-Gesetz (ECG):

Neuvermoebelt GmbH
Handel und Manufaktur für Möbeldesign

FIRMENSITZ:
1210 Wien, Sebastian-Kohl-Gasse 3-9/ Objekt 18

Kontakt:
DI. Christian Bachmann
M.A. Manuela Freigang

E-Mail:
welcome@neuvermoebelt.com

Internetadresse:
tinykitchen.neuvermoebelt.com

Handelsgericht Wien
FN 494541 t
UID: ATU 73496317

Credits:
Gesellschafter/Geschäftsführer/Designer:
DI Christian Bachmann

Gesellschafter/Geschäftsführer/Designer:
M.A. Manuela Freigang

Fotos:
Neuvermoebelt®

Renderings:
Markus Wintersteiger-Wilplinger

Texte:
Neuvermoebelt®

Grafik:
Neuvermoebelt®,
Markus Wintersteiger-Wilplinger

IMPRINT

According to § 5 E-Commerce Law (ECG):

Neuvermoebelt GmbH
Trade and production for furniture design

HEADQUARTERS:
1210 Vienna, Sebastian-Kohl-Gasse 3-9/ Objekt 18

Contact person
DI. Christian Bachmann
M.A. Manuela Freigang

E-Mail:
welcome@neuvermoebelt.com

Web Address:
tinykitchen.neuvermoebelt.com

Commercial Court Vienna
FN 494541 t
UID: ATU 73496317

Credits:
Shareholder/Managing Director/Creator:
DI Christian Bachmann

Shareholder/Managing Director/Creator:
M.A. Manuela Freigang

Photos:
Neuvermoebelt®

Renderings:
Markus Wintersteiger-Wilplinger

Texts:
Neuvermoebelt

Graphics:
Neuvermoebelt®,
Markus Wintersteiger-Wilplinger

